

DNA SERIES

Client PSS Software

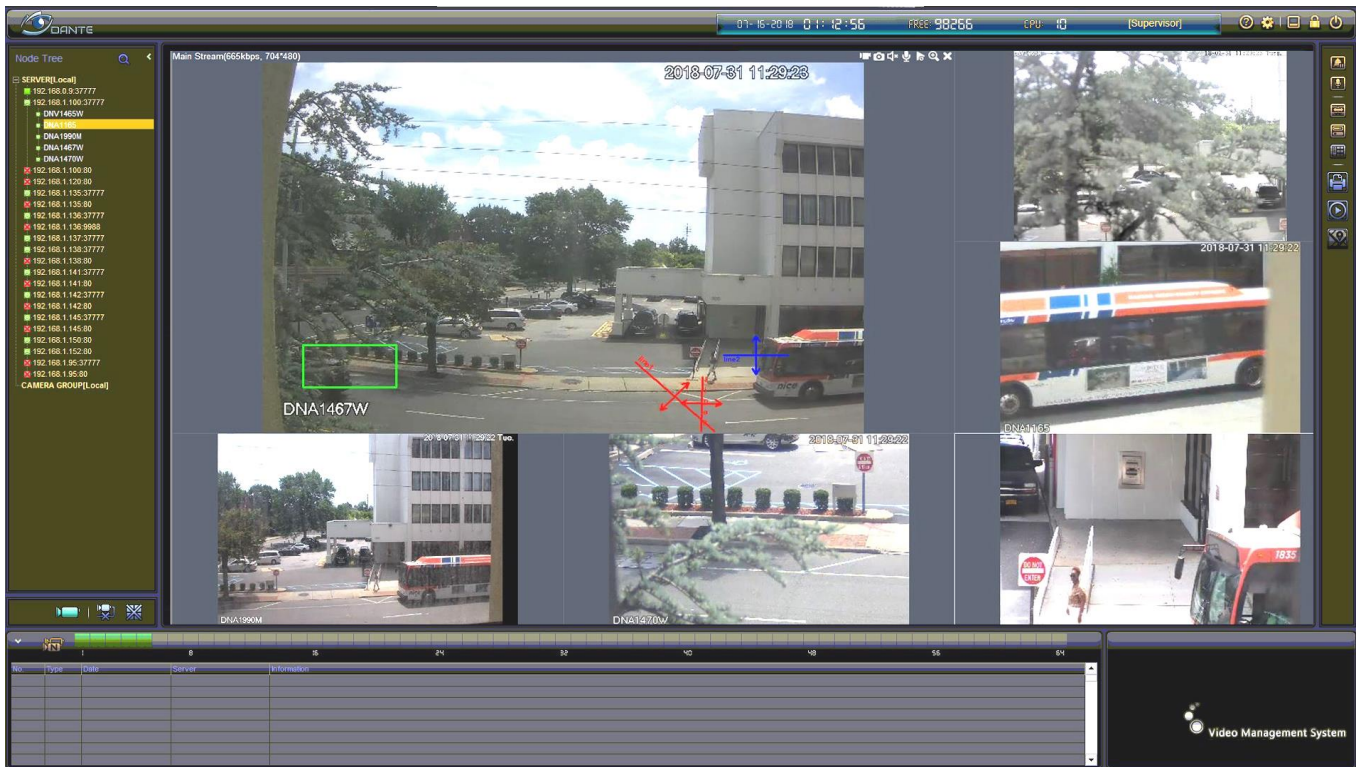

Installation and Operations Manual

Model Number: DNA Series

Client Software

Smart Professional Surveillance System User's Manual

Version 2.0.2

Table of Contents

| | |
|--|------------|
| CYBERSECURITY RECOMMENDATIONS | VII |
| Cybersecurity Recommendations | vii |
| 1. SMARTPSS OVERVIEW | 1 |
| 1.1 SmartPSS Overview | 1 |
| 1.2 SmartPSS Interface | 1 |
| 2. LOGIN..... | 4 |
| 2.1 Initialize Device..... | 4 |
| 2.2 Login SmartPSS | 6 |
| 2.3 Reset Password..... | 8 |
| 3. DEVICES | 11 |
| 3.1 Add Device | 11 |
| 3.1.1 Auto Search | 11 |
| 3.1.2 Manually Add | 12 |
| 3.1.3 Batch Import and Add Device | 14 |
| 3.2 Modify Device Info..... | 14 |
| 3.3 Modify IP..... | 15 |
| 3.4 Delete Device | 16 |
| 3.4.1 Single Delete | 16 |
| 3.4.2 Batch Delete | 17 |
| 4. PREVIEW | 18 |
| 4.1 Introduction to Interface | 18 |
| 4.2 Live View | 19 |
| 4.2.1 Start Live..... | 20 |
| 4.2.2 Live Operation | 20 |
| 4.2.3 Adjust Monitor Window Number | 22 |
| 4.3 E-Map..... | 24 |
| 4.3.1 New Map..... | 24 |
| 4.3.2 Preview Map or Hot Zone | 26 |

| | | |
|------------|--|-----------|
| 4.4 | Config IVS Channel | 27 |
| 4.4.1 | Scene Config | 28 |
| 4.4.2 | General Behavior Analytics | 29 |
| 4.4.2.1 | Enable Behavior Analytics | 30 |
| 4.4.2.2 | Calibration | 30 |
| 4.4.2.3 | Set Detection Zone | 31 |
| 4.4.2.4 | IVS Rule | 32 |
| 4.4.2.5 | Parameters..... | 53 |
| 4.5 | Smart Track Config (Fisheye+Dome) | 54 |
| 4.5.1 | Calibration Requirement | 54 |
| 4.5.2 | Calibrate Camera..... | 55 |
| 4.5.3 | Achieve Smart Track (Fisheye and Dome)..... | 58 |
| 4.6 | Smart Track Config (Dome+Fixed) | 59 |
| 4.6.1 | Calibration Requirement..... | 59 |
| 4.6.2 | Calibrate Camera..... | 60 |
| 4.6.3 | Achieve Smart Track (Fixed and Dome) | 63 |
| 4.7 | PTZ | 67 |
| 4.7.1 | Preset..... | 69 |
| 4.7.2 | Tour..... | 69 |
| 4.7.3 | Scan..... | 70 |
| 4.7.4 | Pattern | 70 |
| 4.7.5 | Enable Windshield Wiper..... | 71 |
| 4.8 | Fisheye View Mode | 71 |
| 4.9 | Device Preview via DNA6336 Keyboard | 72 |
| 5. | TOUR & TASK | 74 |
| 5.1 | Config Task Plan | 74 |
| 5.2 | Enable Task..... | 78 |
| 6. | PLAYBACK | 79 |
| 6.1 | Playback | 79 |
| 6.2 | Playback Device Record | 82 |
| 6.3 | Export Device Record | 82 |
| 6.4 | Playback Device Picture | 84 |
| 6.5 | Export Device Picture | 85 |
| 6.6 | Playback Local Record | 86 |

| | | |
|------------|---------------------------------|------------|
| 6.7 | Export Local Record | 87 |
| 6.8 | Playback Local Picture | 88 |
| 7. | LOG SEARCH | 90 |
| 7.1 | Search Client Log | 90 |
| 7.2 | Search Device Log | 90 |
| 8. | SYSTEM CONFIG | 92 |
| 9. | USER | 95 |
| 9.1 | Role Info | 95 |
| 9.2 | User | 96 |
| 10. | DEVICE CONFIG | 99 |
| 11. | EVENT CONFIG | 102 |
| 11.1 | Event Type | 102 |
| 11.2 | Event Alarm Link Config | 105 |
| 11.2.1 | Link Notice | 105 |
| 11.2.2 | Link Video | 106 |
| 11.2.3 | Link Alarm Output | 108 |
| 11.2.4 | Arm Time | 109 |
| 11.3 | Event View | 110 |
| 12. | VIDEO WALL | 111 |
| 12.1 | Video Wall | 111 |
| 12.2 | Config Favorites | 113 |
| 12.2.1 | Add Favorite | 113 |
| 12.2.2 | Delete Favorite | 115 |
| 12.2.3 | Delete Channel | 115 |
| 12.2.4 | Change Favorite Name | 115 |
| 12.3 | Set Video Wall and Output | 116 |
| 12.4 | Scheme Tour on Video Wall | 118 |
| 12.5 | Playback on Video Wall | 119 |

| | | |
|-------------|-----------------------------------|------------|
| 13. | PEOPLE COUNT | 121 |
| 14. | HEAT MAP | 124 |
| 15. | PC-NVR..... | 125 |
| 15.1 | Disk Manager | 125 |
| 15.2 | Channel Management | 125 |
| 15.3 | Set Record Plan..... | 126 |
| 15.4 | Version Info | 127 |
| 15.5 | Modify Port | 128 |
| 15.6 | Modify Password..... | 129 |
| 16. | VIDEO TALK..... | 130 |
| 16.1 | VTS Center | 130 |
| 16.2 | Monitor | 130 |
| 16.3 | Intercom | 131 |
| 16.4 | Announcement | 135 |
| 16.5 | Search | 136 |
| 16.6 | Issue Card..... | 137 |
| 17. | ACCESS | 141 |
| 17.1 | Console | 141 |
| 17.1.1 | Organizations/Zones..... | 142 |
| 17.1.1.1 | E-Map..... | 142 |
| 17.1.1.2 | Device Control..... | 142 |
| 17.1.2 | List/View..... | 145 |
| 17.1.3 | Event..... | 147 |
| 17.2 | User Management | 148 |
| 17.2.1 | Department Management | 149 |
| 17.2.2 | User Management | 150 |
| 17.2.2.1 | Set Card Type | 150 |
| 17.2.2.2 | Add User | 150 |
| 17.3 | Permission Management..... | 156 |
| 17.3.1 | Period Setup | 156 |

| | | |
|-------------|--------------------------------------|------------|
| 17.3.2 | Holiday Setup | 157 |
| 17.3.3 | Door Group Right..... | 158 |
| 17.3.4 | User Right | 162 |
| 17.3.5 | First Card Unlock | 162 |
| 17.3.6 | Multi-door Lock | 163 |
| 17.3.7 | Anti-pass Back | 166 |
| 17.3.8 | Inter-door Lock..... | 167 |
| 17.3.9 | Remote Verification | 167 |
| 17.4 | Event Configuration..... | 168 |
| 17.5 | Log..... | 171 |
| 18. | ATTENDANCE..... | 173 |
| 18.1 | Console..... | 173 |
| 18.1.1 | ACS Attendance Node Setup | 173 |
| 18.1.2 | Extract Card Info | 174 |
| 18.2 | User | 174 |
| 18.2.1 | Department/User | 174 |
| 18.2.2 | Right..... | 174 |
| 18.2.2.1 | Enable Attendance Right | 175 |
| 18.2.2.2 | Disable Attendance Right | 177 |
| 18.3 | Set Attendance | 177 |
| 18.3.1 | Set Attendance Timezone | 177 |
| 18.3.2 | Set Attendance Shift | 180 |
| 18.3.3 | Set Holiday..... | 182 |
| 18.4 | Shift | 183 |
| 18.4.1 | General Shift..... | 183 |
| 18.4.2 | Temporary Shift | 186 |
| 18.4.3 | Set Default Shift for New User..... | 187 |
| 18.5 | Report..... | 188 |
| 18.5.1 | Extract Attendance Info | 188 |
| 18.5.2 | Attendance Statistics | 189 |
| 18.5.3 | Exception Attendance Processing..... | 190 |

Welcome

Thank you for using our Smart Professional Surveillance System (SmartPSS)!
This user's manual is designed to be a reference tool for operation of your system.
Here user may find detailed operation information about SmartPSS.

Cybersecurity Recommendations

Cybersecurity Recommendations

Mandatory actions to be taken towards cybersecurity

1. Change Passwords and Use Strong Passwords:

The number one reason systems get “hacked” is due to having weak or default passwords. It is recommended to change default passwords immediately and choose a strong password whenever possible. A strong password should be made up of at least 8 characters and a combination of special characters, numbers, and upper and lower case letters.

2. Update Firmware

As is standard procedure in the tech-industry, we recommend keeping NVR, DVR, and IP camera firmware up-to-date to ensure the system is current with the latest security patches and fixes.

“Nice to have” recommendations to improve your network security

1. Change Passwords Regularly

Regularly change the credentials to your devices to help ensure that only authorized users are able to access the system.

2. Change Default HTTP and TCP Ports:

- Change default HTTP and TCP ports for systems. These are the two ports used to communicate and to view video feeds remotely.
- These ports can be changed to any set of numbers between 1025-65535. Avoiding the default ports reduces the risk of outsiders being able to guess which ports you are using.

3. Enable HTTPS/SSL:

Set up an SSL Certificate to enable HTTPS. This will encrypt all communication between your devices and recorder.

4. Enable IP Filter:

Enabling your IP filter will prevent everyone, except those with specified IP addresses, from accessing the system.

5. Change ONVIF Password:

On older IP Camera firmware, the ONVIF password does not change when you change the system’s credentials. You will need to either update the camera’s firmware to the latest revision or manually change the ONVIF password.

6. Forward Only Ports You Need:

- Only forward the HTTP and TCP ports that you need to use. Do not forward a huge range of numbers to the device. Do not DMZ the device's IP address.
- You do not need to forward any ports for individual cameras if they are all connected to a recorder on site; just the NVR is needed.

7. Disable Auto-Login on SmartPSS:

Those using SmartPSS to view their system and on a computer that is used by multiple people should disable auto-login. This adds a layer of security to prevent users without the appropriate credentials from accessing the system.

8. Use a Different Username and Password for SmartPSS:

In the event that your social media, bank, email, etc. account is compromised, you would not want someone collecting those passwords and trying them out on your video surveillance system. Using a different username and password for your security system will make it more difficult for someone to guess their way into your system.

9. Limit Features of Guest Accounts:

If your system is set up for multiple users, ensure that each user only has rights to features and functions they need to use to perform their job.

10. UPnP:

- UPnP will automatically try to forward ports in your router or modem. Normally this would be a good thing. However, if your system automatically forwards the ports and you leave the credentials defaulted, you may end up with unwanted visitors.
- If you manually forwarded the HTTP and TCP ports in your router/modem, this feature should be turned off regardless. Disabling UPnP is recommended when the function is not used in real applications.

11. SNMP:

Disable SNMP if you are not using it. If you are using SNMP, you should do so only temporarily, for tracing and testing purposes only.

12. Multicast:

Multicast is used to share video streams between two recorders. Currently there are no known issues involving Multicast, but if you are not using this feature, deactivation can enhance your network security.

13. Check the Log:

If you suspect that someone has gained unauthorized access to your system, user may check the system log. The system log will show you which IP addresses were used to login to your system and what was accessed.

14. Physically Lock Down the Device:

Ideally, you want to prevent any unauthorized physical access to your system. The best way to achieve this is to install the recorder in a lockbox, locking server rack, or in a room that is behind a lock and key.

15. Connect IP Cameras to the PoE Ports on the Back of an NVR:

Cameras connected to the PoE ports on the back of an NVR are isolated from the outside world and cannot be accessed directly.

16. Isolate NVR and IP Camera Network

The network your NVR and IP camera resides on should not be the same network as your public computer network. This will prevent any visitors or unwanted guests from getting access to the same network the security system needs in order to function properly.

1. SmartPSS Overview

1.1 SmartPSS Overview

SmartPSS is an abbreviation for Smart Professional Surveillance System.

The software is to manage small quantity security surveillance devices. It releases with the device and does not support the products from other manufacturers. It has the following features:

- Software password reset.
- View real-time video of several camera channels.
- View the playback video files from various cameras.
- Support multiple scheduled arms to realize auto PC guard.
- Support e-map; user may clearly view and manage all device locations.
- Video wall preview.
- People count and heat map.
- Search and export log.
- Support config and management of A&C device.
- Support config and management of intercom device.
- Support config and management of time attendance.
- Support config and management of alarm controller.

1.2 SmartPSS Interface

SmartPSS software interface includes 5 parts: function tab, system info, function list, shortcut, and help. See Figure 1-1.

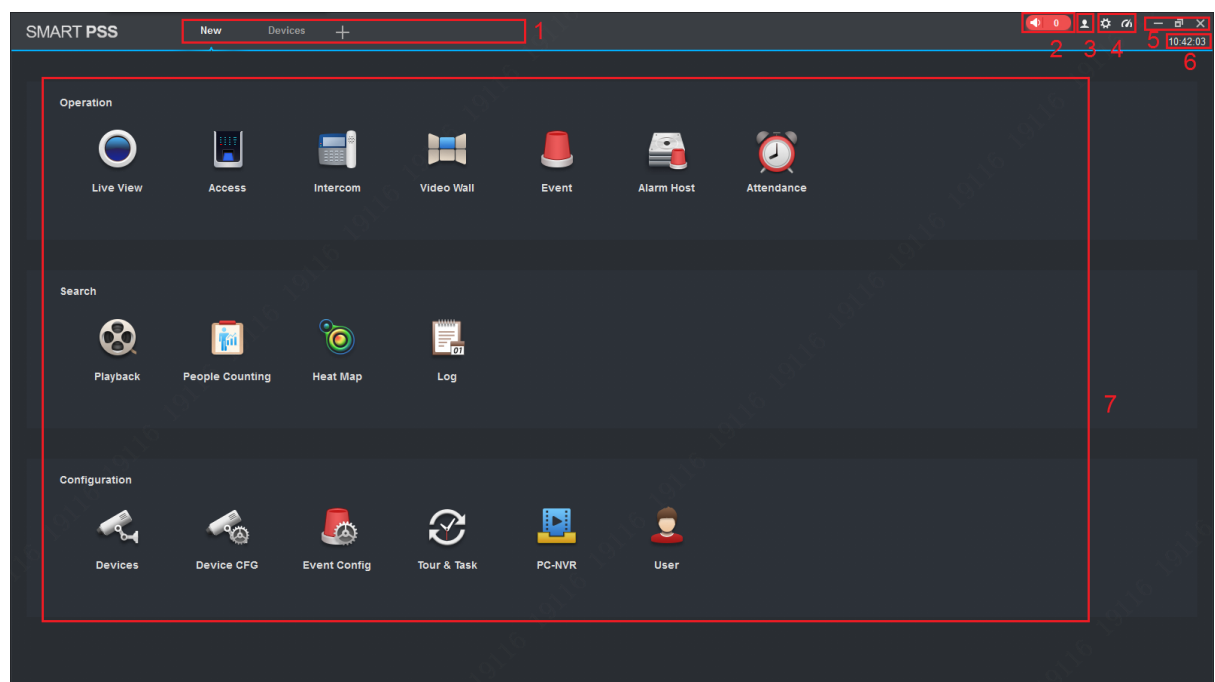

















Figure 1-1

| N o. | Name | Note |
|---------|--|---|
| 1 | Function tab | In default status, it shows Device tab, New tab and  . Click  , user may add new tab. If you open function in New tab, it enters corresponding function interface, and meantime tab name is updated to new function name. |
| 2 | Event | <ul style="list-style-type: none"> ●  and . Click icon to switch event alarm between mute and sound. ●  (example only), click icon to enter Event interface. |
| 3 | <ul style="list-style-type: none"> ● User | <ul style="list-style-type: none"> ● Click , select lock screen. ● Click , select switch user. ● Click , select help manual. ● Click , select about, to show software version and date. ● Click , select user wizard to show new function and features. |
| 4 | System Management | <ul style="list-style-type: none"> ● Click , enter system config interface. It supports base, preview and playback, device manager and etc. ● Click , show system CPU occupancy status and memory. If CPU occupancy is high, the icon will become red as warning. |
| 5 | Window | <ul style="list-style-type: none"> ● Click , minimize window. ● Click , maximize window. ● Click , to restore window. ● Click , exit. |
| 6 | System Time | Current system time. |

| | | |
|---|---------------|--|
| 7 | Function List | <p>Function list has operation area, search area and config area.</p> <ul style="list-style-type: none"> ● Live View Connect to camera, to achieve live preview. It supports local record, snapshot, audio on, talk, instant playback, zoom in video, switch stream, config device parameter, config intelligent channel and etc. ● Access Connect to access control device, support A&C monitoring, e-map, video link, user management and etc. ● Intercom Connect to intercom device, support call, live preview, remote unlock, send info and etc. ● Video Wall Video on wall. ● Event View, process and mark event. ● Playback Playback and export device record, device picture, local record and local picture. ● People Counting View and export people count info within a certain period, support contrast of different channels or people count info. ● Heat Map Search and export heat map within a certain period. ● Log Search and export client log and device log. ● Devices Search and add device, batch import or export device info, modify and delete device info. ● Device CFG Configure camera, network, event, storage and system. ● Event Config Include channel event, alarm controller event, external alarm and device event. User may set alarm notice, alarm link video, alarm output and arm time. ● Tour&Task Config and manage tour plan. ● PC-NVR Connect to NVR, manage NCR disk and set record plan. ● User Add, modify and delete user and role, and manage role and user right. |
|---|---------------|--|

Chart 1-1

2. Login

The chapter introduces how to login SmartPSS. For first time login, you shall initialize the device, set login password. If you forget the password, user may reset password via password reset function.

2.1 Initialize Device

After SmartPSS installation is complete, you login it for the first time. Please follow system instructions to set admin login password and password security. This password set here is used to login system. Password security requires to answer security questions to reset password.

Steps



Step 1. Double click . See Figure 2-1.

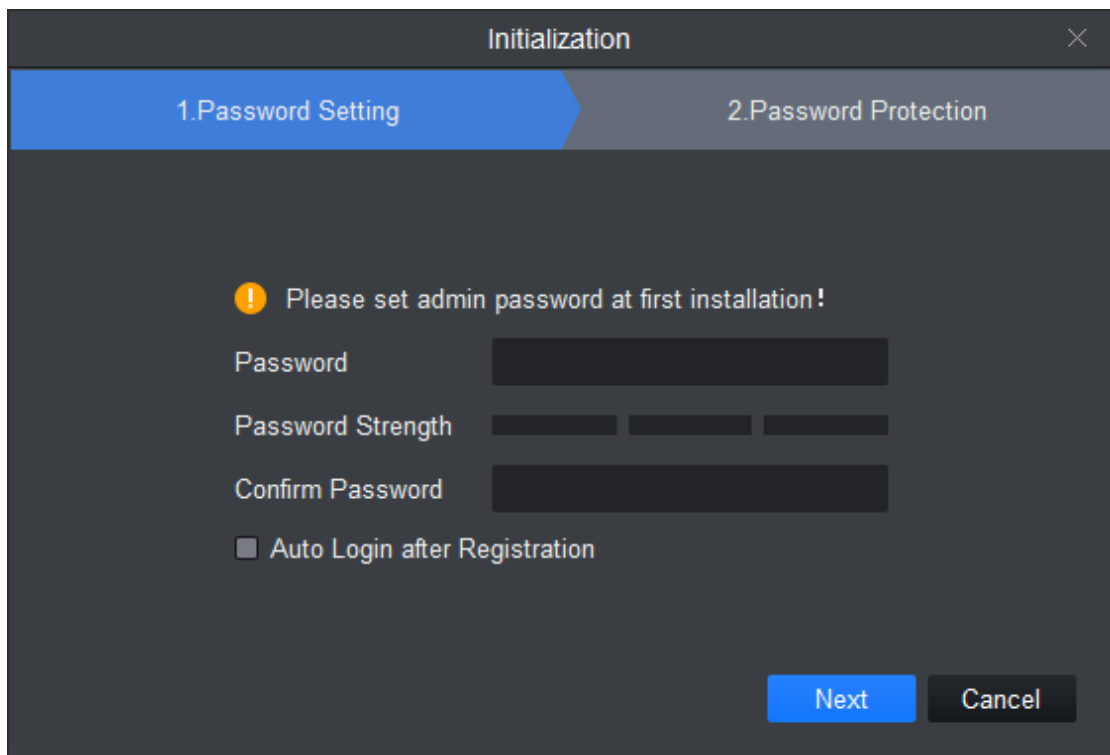

Initialization

1.Password Setting 2.Password Protection

! Please set admin password at first installation!

Password

Password Strength

Confirm Password

Auto Login after Registration

Next Cancel

Figure 2-1

Step 2. Set password, see Figure 2-2.

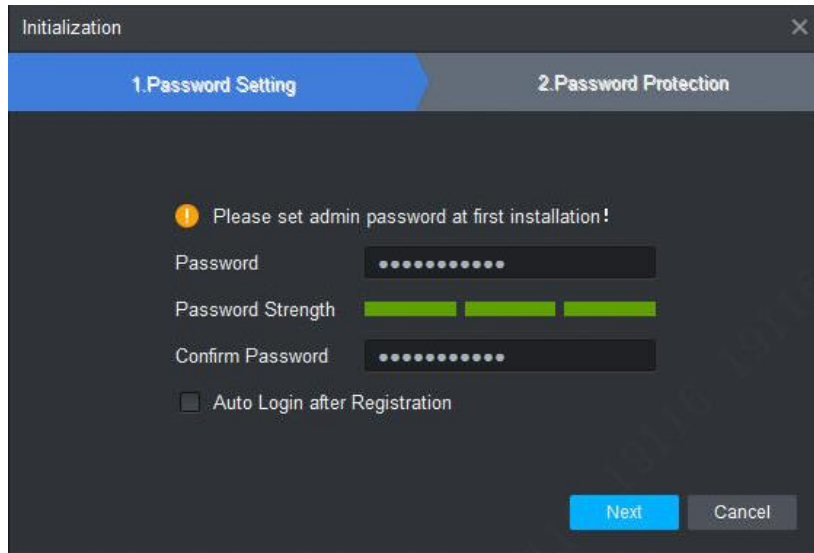

Figure 2-2

| Parameter | Note |
|-------------------------------|--|
| Password | Password can be 8~32 digits without space. It contains at least two types of upper case, lower case, number and symbol (except “'”, “'””, “;”, “.”, or “&”). |
| Password Strength | It feedbacks password complexity. Red means password is not complex enough, and greens means password complexity is OK. Please set password according to its strength. |
| Confirm Password | Match password set above. |
| Auto login after registration | Enable this option, so when registration complete, you will automatically log in the system. |

Chart 2-1

Step 3. Click Next, see Figure 2-3.



Figure 2-3

Step 4. Select question and answer it. In case you forget password, you may reset password through these questions.

Step 5. Click Finish, save config.

2.2 Login SmartPSS

After device initialization complete, enter username and login password.



Step 1. Double click , see Figure 2-4.

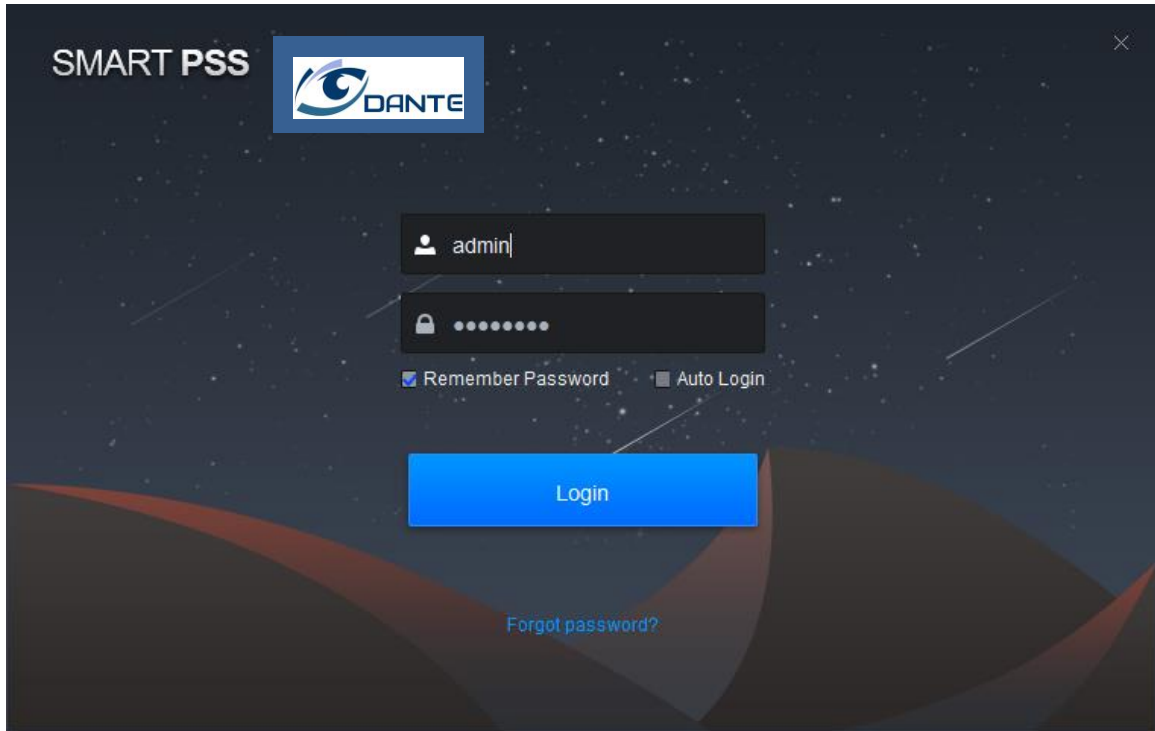

Figure 2-4

Step 2. Set parameter, see Chart 2-2.



| Parameter | Note |
|---|--|
|  | Enter username and password. |
|  | |
| Remember password | Select it, system remember password and at next time of login, this password will be remembered. |
| Auto Login | Select it, it auto remember password, and it will auto login at next time. |
| Forget password | When you forget password, user may answer security question to reset password. See Ch 2.3. |

Chart 2-2

Step 3. Click Login, see Figure 2-5.

Note:

If it is the first time login, the system will show wizard of user to introduce new function and features.

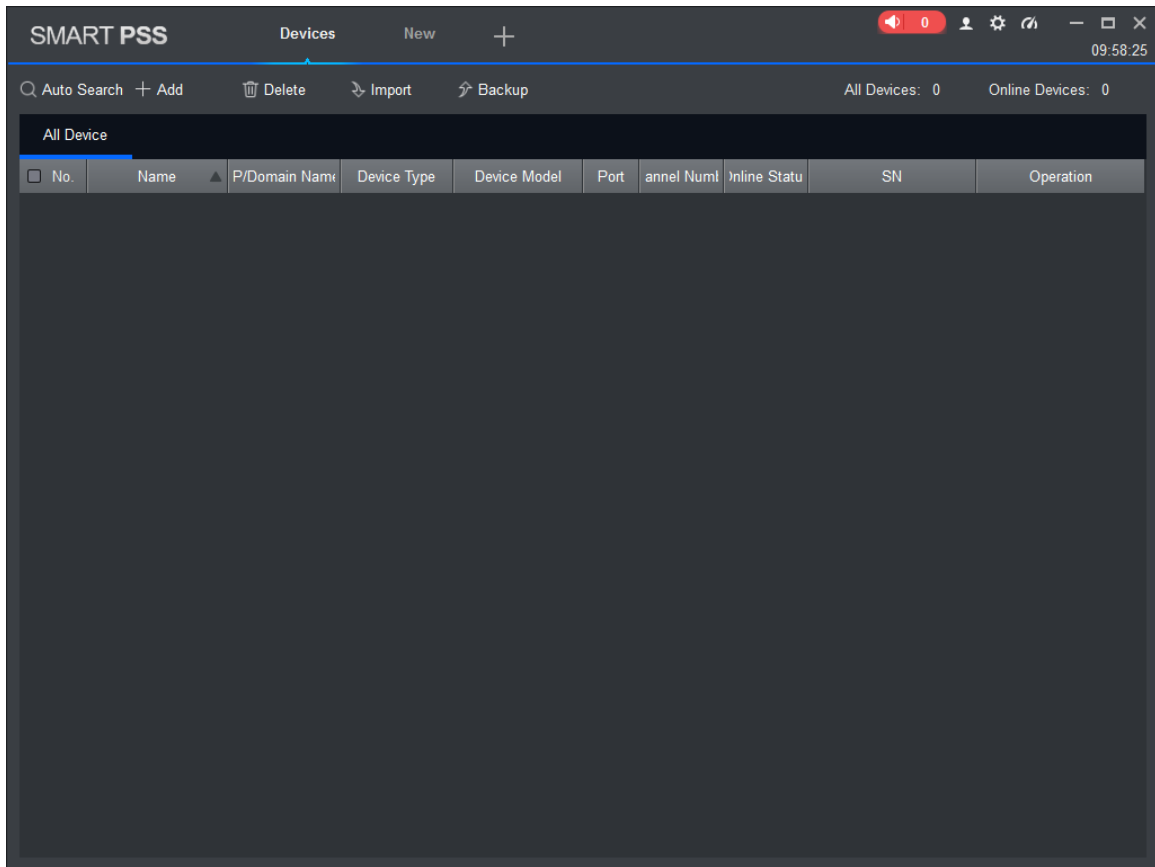



Figure 2-5

2.3 Reset Password

When you forget password, please answer security question to reset password.



Step 1. Double click , see Figure 2-6.

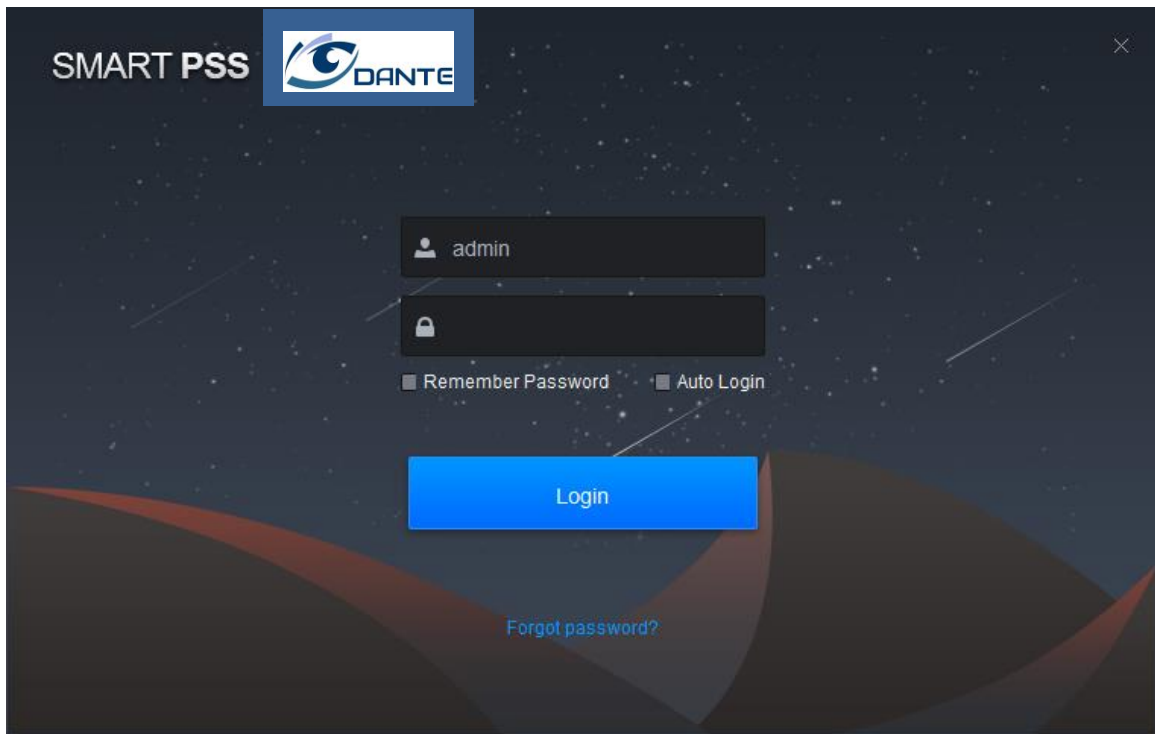

Figure 2-6

Step 2. Click **Forgot password?**, see Figure 2-7.

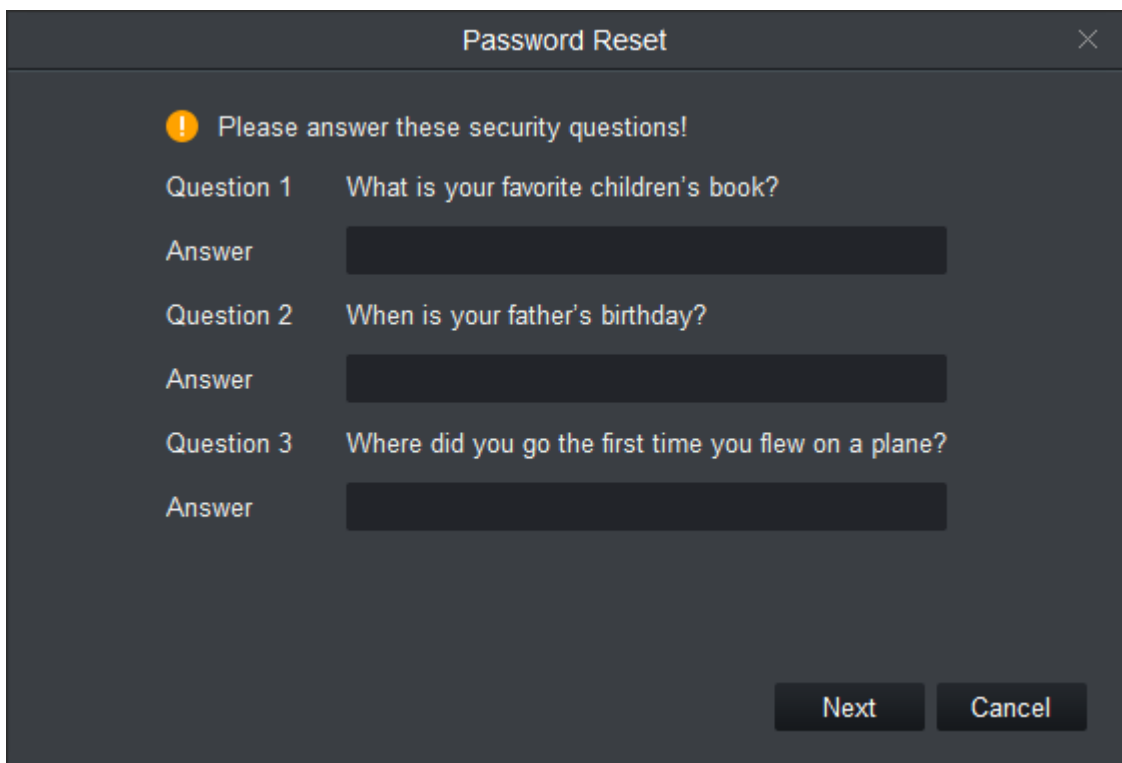

Figure 2-7

Step 3. Answer security question, click Next, see Figure 2-8.

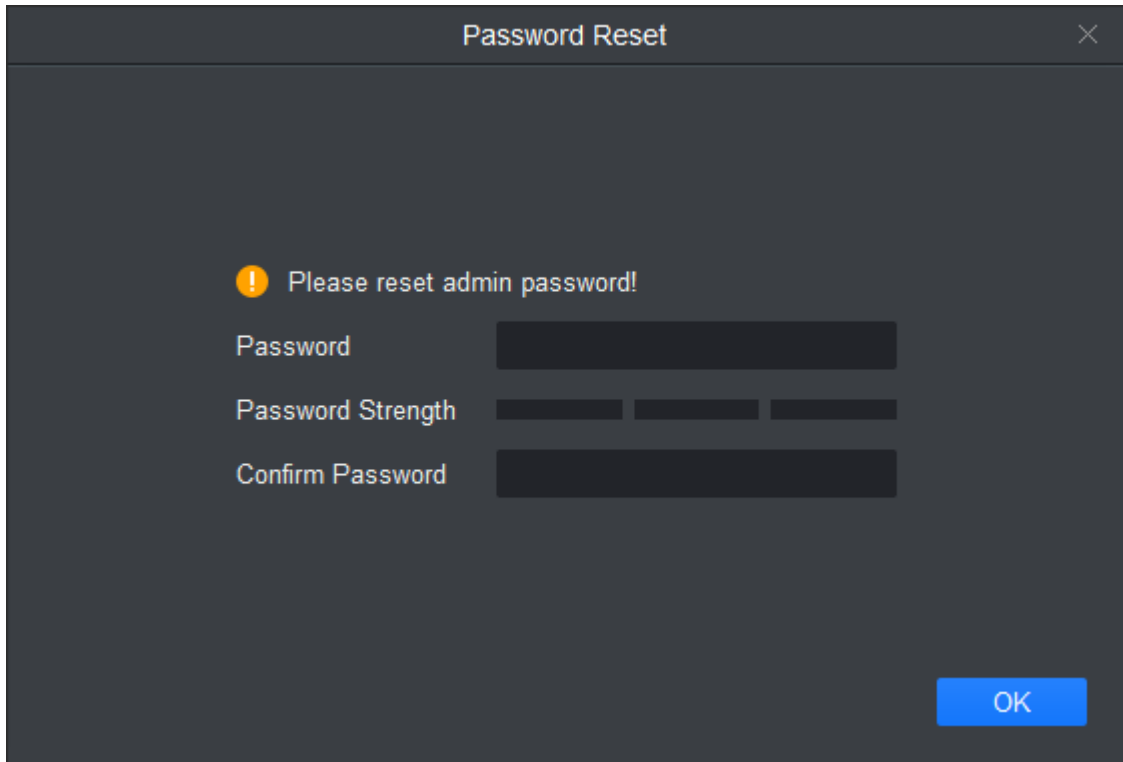

Figure 2-8

Step 4. Set password, see Chart 2-3.

| Parameter | Note |
|-------------------|--|
| Password | Password can be 8~32 digits without space. It contains at least two types of upper case, lower case, number and symbol (except “” , “” , “,” , “.,” or “&”). |
| Password Strength | Feedback password strength. Red means weak password, and green means secure password. |
| Confirm Password | Match password set above. |

Chart 2-3

Step 5. Click OK.

3. Devices

SmartPSS supports to add a single device or batch device (i.e. IPC, NVR) via auto search. You also can config and operate device.

3.1 Add Device

SmartPSS supports to add device via multiple methods, please select method to add device according to device quantity, segment and etc.

3.1.1 Auto Search

You must add device as batch and make them in the same segment, or if you do not know device IP, user may uses this method to add device when you only know device segment.

Step 1. In Devices, click Search.

Step 2. Set device segment and click Auto Search. See Figure 3-1.

Note:

- Click Refresh, to refresh searched device.
- Check device IP you want to modify, click Modify IP to change IP. See Ch 3.3.

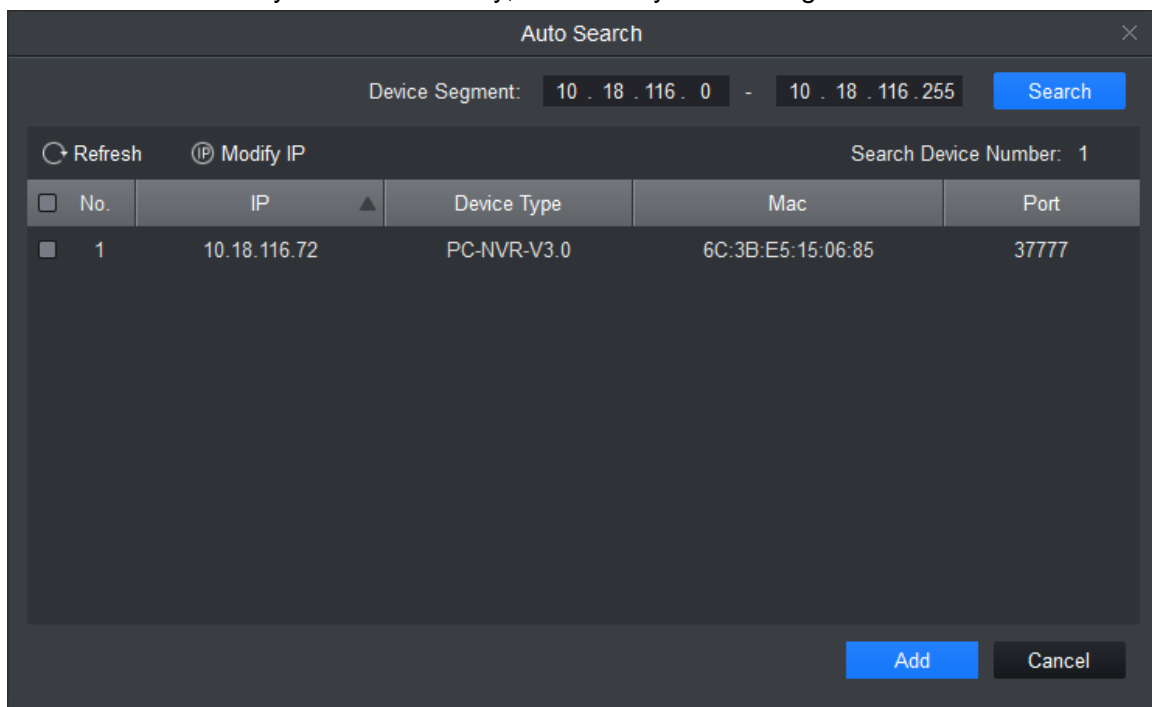

Figure 3-1

Step 3. Check device you want to add, click Add.

Step 4. Click OK. Login box pops up.

Step 5. Enter device username and password. Click OK. System shows device list added. See Figure 3-2.

- After device is added, it stays at auto search page, user may continue to add device or click Cancel to exit.
- After device is added, SmartPSS auto logs in device. Login is successful, then online status changes to “online”, otherwise it is “offline”.

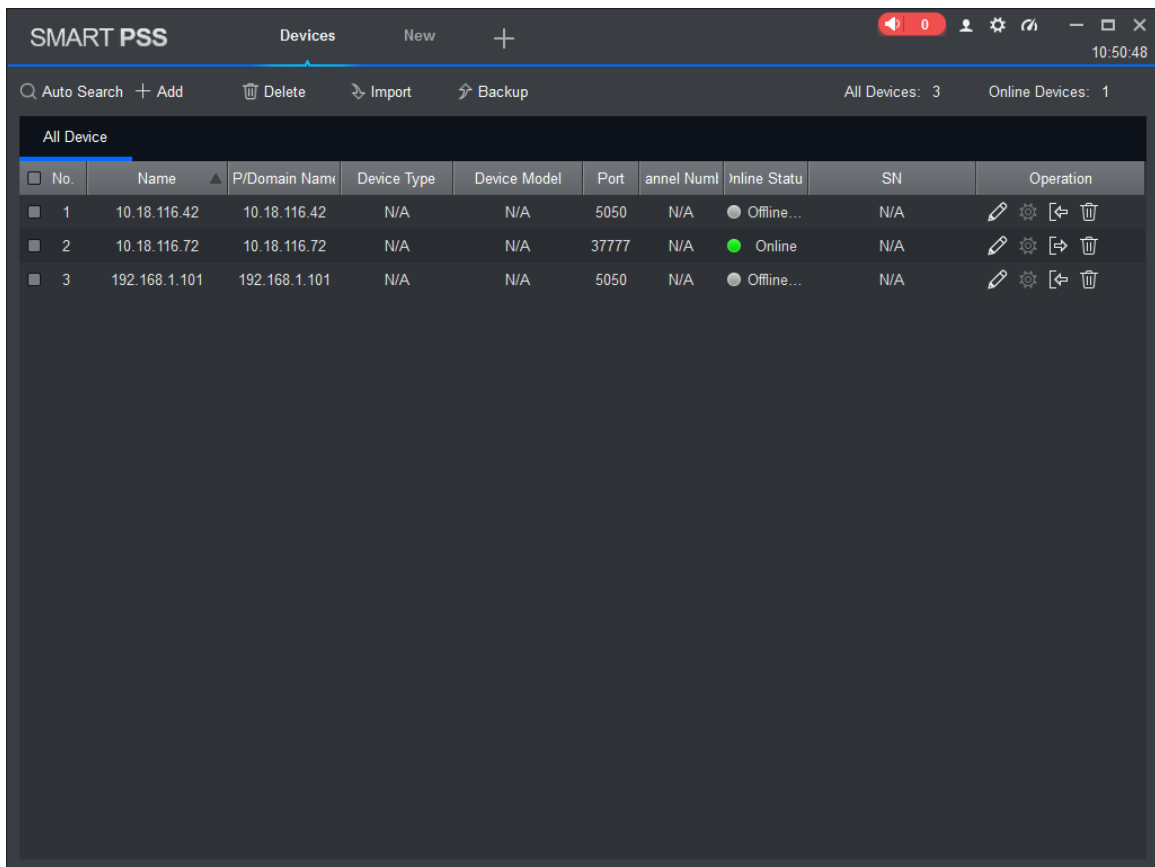

Figure 3-2

| Icon | Note |
|------|---|
| | Click this icon, enter Modify Device interface, user may modify device info, including device name, IP/domain, port, username and password. User may double click device to enter Modify Device interface. |
| | Click this icon, enter Device Config interface, user may set its camera, network, event, storage and system info. |
| | <ul style="list-style-type: none"> Device in login status, icon is . Click this icon to exit device, it changes to . Device is offline, icon is . Click this icon, login device (with correct device info), icon changes to . |
| | Click this icon to delete device. |
| | When you select to show device code, this icon will be shown. Click this icon to custom device code for future keyboard pairing. |

Chart 3-1

3.1.2 Manually Add

When you add a single device, and support device IP and domain name, we recommend you to manually add device.

Step 1. In Devices interface, click Add, see Figure 3-3.

Figure 3-3

Step 2. Set device parameter, see the following chart.

| Item | Function |
|----------------|--|
| Device name | Please input a device name here. |
| Method to add | By IP/domain and SN. |
| IP/Domain name | Device IP address or domain name. Note: User may add device of IPV6 address. |
| SN | Device SN. Note: For P2P device only. |
| Port | Device IP port. It is 37777 by default. |
| Group Name | User may choose one group. |
| User name | The user name you login the device. |
| Password | The password you login the device. |

Chart 3-2

Step 3. Click Add, complete adding of device.

Note:

- If you continue to add device, then click Save and Continue to add device and save the manually added device.
- If user maycel adding, then click Cancel to exit.
- After device is added, SmartPSS auto logs in the device. When it successfully logs in, the device status becomes “online”, otherwise it is “offline”.

3.1.3 Batch Import and Add Device

If devices you want to add are not under the same segment, user may prepare device info file (.xml format) and import it into device.

Note:

If you need a template of device info, user may export it in Device interface.

Step 1. In Devices, click Import. See Figure 3-4.

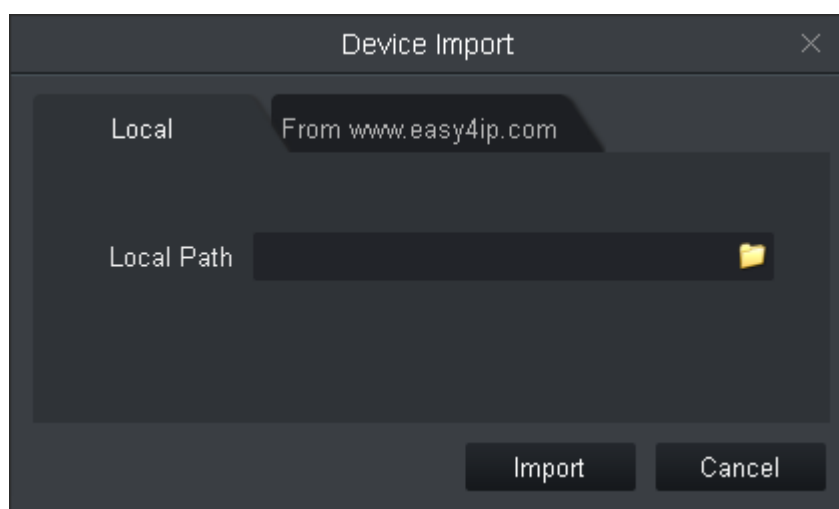

Figure 3-4

Step 2. According to actual condition, select import method.

- Select Local tab to select device info locally.
- Enter username and password.

Step 3. Click Import. When successfully imported device, system shows a message, click OK.

Note:

After device is added, SmartPSS auto logs in the device. When it successfully logs in, the device status becomes “online”, otherwise it is “offline”.

3.2 Modify Device Info

Add device info (username, password, IP/domain) which is wrong or shall be updated, user may change info here.

Note:

This chapter introduces how to change device info, please refer to Ch 10.

Step 1. In Device interface, click  next to device you want to modify, or double click device.

See Figure 3-5.

The 'Modify Device' dialog box is shown with the following fields and values:

- Device Name: * 10.18.116.42
- Method to add: IP/Domain
- IP/Domain Name: * 10.18.116.42
- Port: * 5050
- Group Name: Default Group
- User Name: * admin
- Password: •••••

Buttons: Save, Cancel

Figure 3-5

Step 2. Change device info, refer to Chart 3-2.

Step 3. Click Save.

3.3 Modify IP

Step 1. In Devices interface, click Auto Search.

Step 2. Set device segment and click Search. See Figure 3-6.

The 'Auto Search' dialog box is shown with the following fields and options:

- Device Segment: 10 . 18 . 116 . 0 - 10 . 18 . 116 . 255
- Search: [Search]
- Refresh: [Refresh]
- Modify IP: [Modify IP]
- Search Device Number: [Search Device Number]

| No. | IP | Device Type | Mac | Port |
|-----|----|-------------|-----|------|
| | | | | |

Buttons: Add, Cancel

Figure 3-6

Step 3. Check device you want to modify IP, click Modify IP. System pops up modify device IP box.

Step 4. Enter device IP info. Click OK.

- When you check a single device, system pops up Modify IP box, see Figure 3-7.

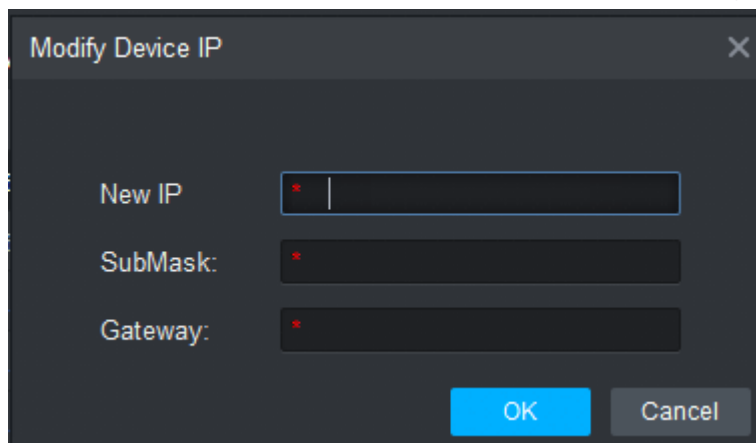

Figure 3-7

- When select more than one device, system pops up Batch Modify IP box, see Figure 3-8.



Figure 3-8

Step 5. Set device new IP start IP, subnet mask and gateway.

Step 6. Click Save.

3.4 Delete Device

If device added is no longer managed, please delete the device. User may delete one by one or by batch.

3.4.1 Single Delete

Step 1. In Device interface, click  next to device you want to delete, see Figure 3-9.

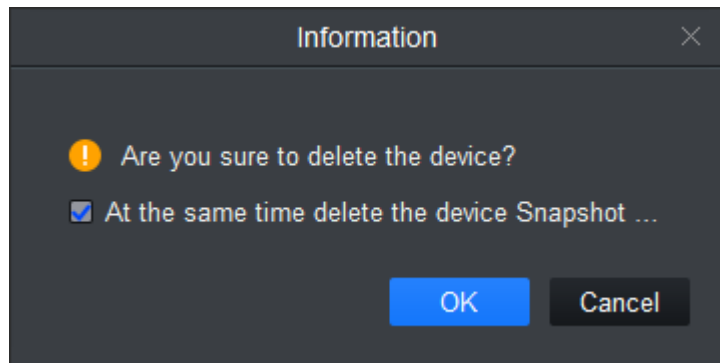

Figure 3-9

Step 2. According to actual condition, check select “at the same time delete the delete snapshot and record” or not.

Step 3. Click OK.

3.4.2 Batch Delete

Step 1. In Device interface, select device to delete.

Step 2. Click Delete. See Figure 3-9.’

Step 3. According to actual condition, check select “at the same time delete the delete snapshot and record” or not.

Step 4. Click OK.

4. Preview

After you add device on SmartPSS, user may enter Live View interface to preview. You also can set e-map and etc.

4.1 Introduction to Interface

The following introduce each part and function of interface.

Click , in New interface select Live View, see Figure 4-1.

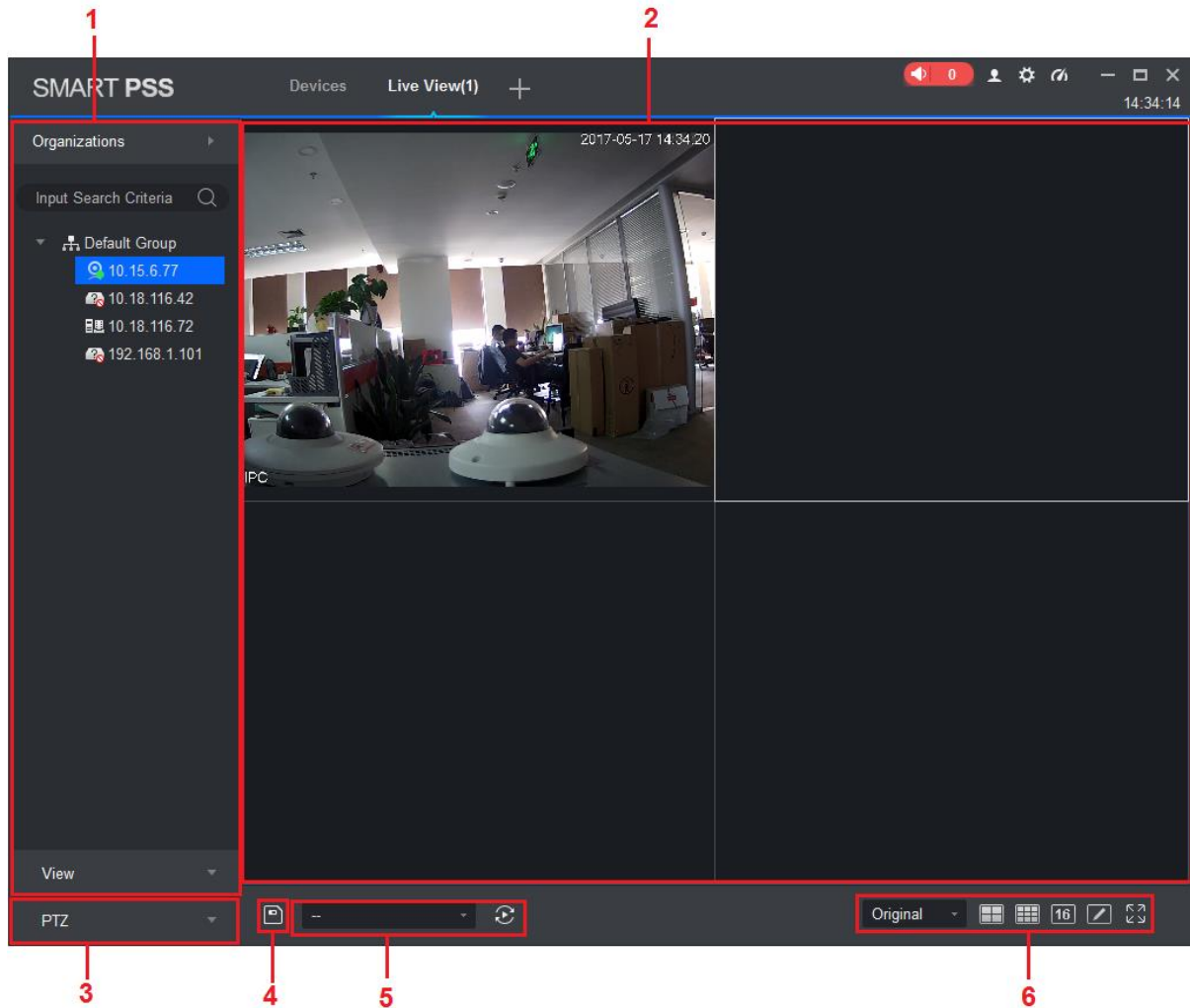

Figure 4-1

| No. | Name | Note |
|-----|------|------|
|-----|------|------|

| No. | Name | Note |
|-----|-------------------------------|---|
| 1 | Device list | <p>User may switch streams, create device groups, create new maps, update channel information, modify channel names, log off, and log in to devices.</p> <ul style="list-style-type: none"> ● When the Default Device Tree is set to Device Tree (by device), the device tree displays the grouping and channels for the device. ● When the Default Device Tree is set to Area Tree (by channel), the device tree displays the zones and channels. Here makes organization tree as an example. Area tree is same with organization tree. <p>Device list supports to manage device (rename and delete group), switch stream, create map, enter device config, master-slave config, intelligent default and etc.</p> <p>Steps:</p> <ul style="list-style-type: none"> ● Right click in space area, user may create group, same level with default group. ● Right click to create group (create group under selected group), rename group, select stream (apply to all channels in group), create map. ● Right click one channel (device is online), and user may switch stream, enable alarm output, update channel info, enter device config, intelligent default, master-slave config interface, log out. ● Right click channel (device is offline), log in device. |
| 2 | Preview Window | Browse this area, window can be split into various modes. User may snapshot, record during preview. It supports tour, talk, IVS overlay and etc., refer to Ch 4.2. |
| 3 | PTZ | <ul style="list-style-type: none"> ● For motorized zoom devices, focus, autofocus, or focus can be reset. ● For PTZ setting, user may simulate the mouse, open or close PTZ menu, adjust PTZ speed, direction, zoom, focus and iris. <p>Click More Features to set Preset, Tour, Horizontal Rotation, Scan, Track, and Accessibility. See Ch 4.7.</p> |
| 4 | Save View | <p>When there is many devices connected, and you often preview more than once window at the same time, user may save preview as view of multiple devices, so when you enable this view in the future, it will auto open device preview saved.</p> <p>Saved views are shown below view tab under device list, and can be added to tour plan and the same time.</p> |
| 5 | Tour | When tour plan exists, user may select tour quickly here. |
| 6 | Aspect Ratio and Window Split |  <p>adjust aspect ratio</p> <p>adjust split</p> |

Chart 4-1

4.2 Live View

User may live view video, local record, snapshot, enable audio, talk, instant playback, zoom in video, switch stream, config device parameter, config intelligent channel, config master-slave track, update channel info and etc.

4.2.1 Start Live

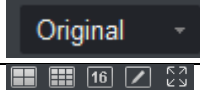
User may preview via:

- Select preview window, double click to preview in device list.
- Drag device you want to preview into window.

See Figure 4-2.

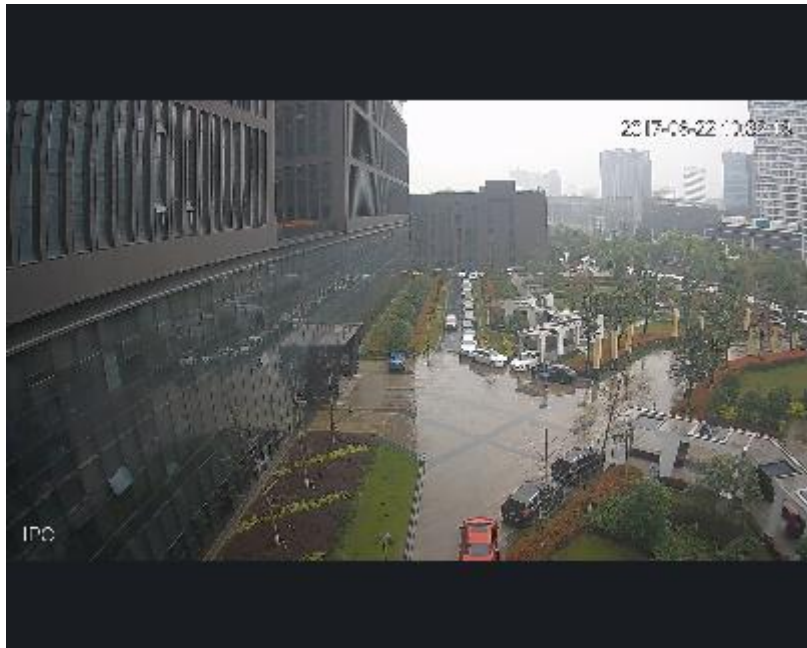











Figure 4-2

4.2.2 Live Operation

| No. | Task | Note | Operation |
|-----|-------------------|---|--|
| 1 | Open local record | Save record to local | Select open video window which is ON, and click  or right click to select Start Record. Note: User may modify the saved path in System Configuration> File Settings . |
| 2 | Snapshot | Manually snapshot | Select open video window which is ON, and click  or right-click to select Snapshot, snapshot a single picture. Note: User may change the path where the image is saved in System Configuration> File Settings . |
| 3 | Triple Snapshot | Snapshot three pictures at once | Select the preview video window, right click Triple Snapshot, the system continuously snapshot three pictures. |
| 4 | Start audio | Start audio to get audio message sent to device | Select open video window which is ON, and click  or right-click to select Start Audio. |
| 5 | Talk | Talk to connected device | Select open video window which is ON, and click  or right-click to select Start Talk, user may talk between the client and the device. |

| No. | Task | Note | Operation |
|-----|-----------------------------|--|--|
| 6 | Turn on the remote intercom | When you preview the channel under the storage device, and the device supports remote channel intercom, select the video window with preview opened, right-click to select Turn on the remote intercom, the remote channel on the client and the storage device can be speak. | Select open preview window, right click to select remote intercom. |
| 7 | Start instant playback | Playback record 1-60 min prior of current channel | Select open video window which is ON, and click  or right-click to select Start Instant Playback . |
| 8 | Zoom in | Select area to zoom in | Select open video window which is ON, and click  . |
| 9 | Close window | N/A | Select open video window which is ON, and click  or right click to select Close Window . |
| 10 | Close all windows | N/A | Select the video window, right-click to select Close All Windows . |
| 11 | Playback | Playback record video. | Select the preview video window, right-click Playback to enter the Playback interface. See Ch 6. |
| 12 | Fisheye installation | For fisheye device only. Fisheye installation mode includes  (Ceiling),  (Wall mount) and  (GND). | Select the video window with preview ON, right click on Fisheye Installation Mode and select the installation mode according to the actual installation of the device. |
| 13 | Fisheye view mode | For fisheye device only. The view mode is different depending on the installation mode of the fisheye. See Ch 4.8. | Select the preview video window, right-click the Fisheye view mode, according to the actual situation to select the desired view mode. |
| 14 | Split screen tracking | Split screen tracking includes the normal mode, 1 +3 mode and 1 +5 mode three modes. <ul style="list-style-type: none">• Normal mode: Original image.• 1 + 3 mode: the original image and 3 sub-window, the original image can be adjusted 3 sub-window position.• 1 + 5 mode: the original image and 5 sub-window, the original image can be adjusted 5 sub-window position. | Select enabled preview window, right click split screen tracking, and select split. |

| No. | Task | Note | Operation |
|-----|----------------------|---|---|
| 15 | Adjust | It is used to adjust the preview effect of the video screen on the client and does not change the actual image parameters of the device. User may adjust the brightness, contrast, saturation and hue of the video screen. | <ol style="list-style-type: none"> 1. Select open preview window, right click select image adjust. 2. Adjust image, click exit. |
| 16 | Smart overlay | Make intelligent rules or intelligent object box displayed in the video screen. | Select the video window with the preview turned on, right-click on the Intelligent overlay> Intelligent rule or Intelligent object box. |
| 17 | Set video scale | Adjust aspect ratio of video. | Select the video window, right-click to select Window Scale, select the video screen display ratio. |
| 18 | Switch play strategy | Play strategy includes balance, real-time and fluency. | Select enabled video window, right click window and select play strategy. |
| 19 | Switch stream | Support main stream, sub stream1 and sub stream 2. | Select enabled video window, right click stream type. |

Chart 4-2

4.2.3 Adjust Monitor Window Number

Click , to adjust window number. The first three icons are commonly used for favorites, and the fourth window is custom window plus the fifth window is full screen.

- Favorites common windows

Click , in standard interface, user may select window split number. You may add number of split up to 3 favorites. When you see a star marked at upper right corner, it means favorite is successfully added. See Figure 4-3.

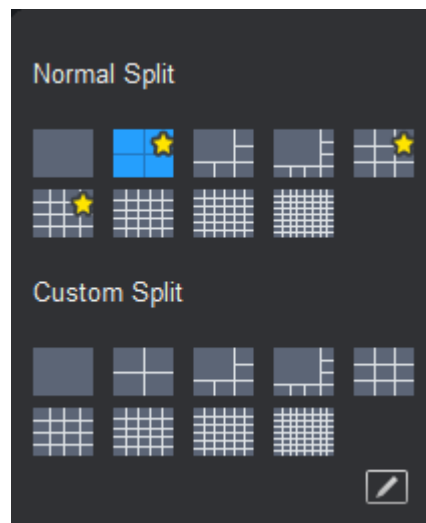

Figure 4-3

- Customize window split.

1. Click . See Figure 4-4.

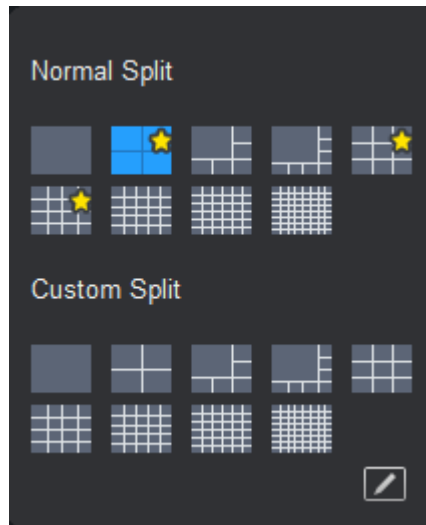



Figure 4-4

2. Customize window number.

- In custom area, there are 9 splits. Click icon to split into corresponding number of windows.

- If you want to split window again, click  to set, see Figure 4-5.

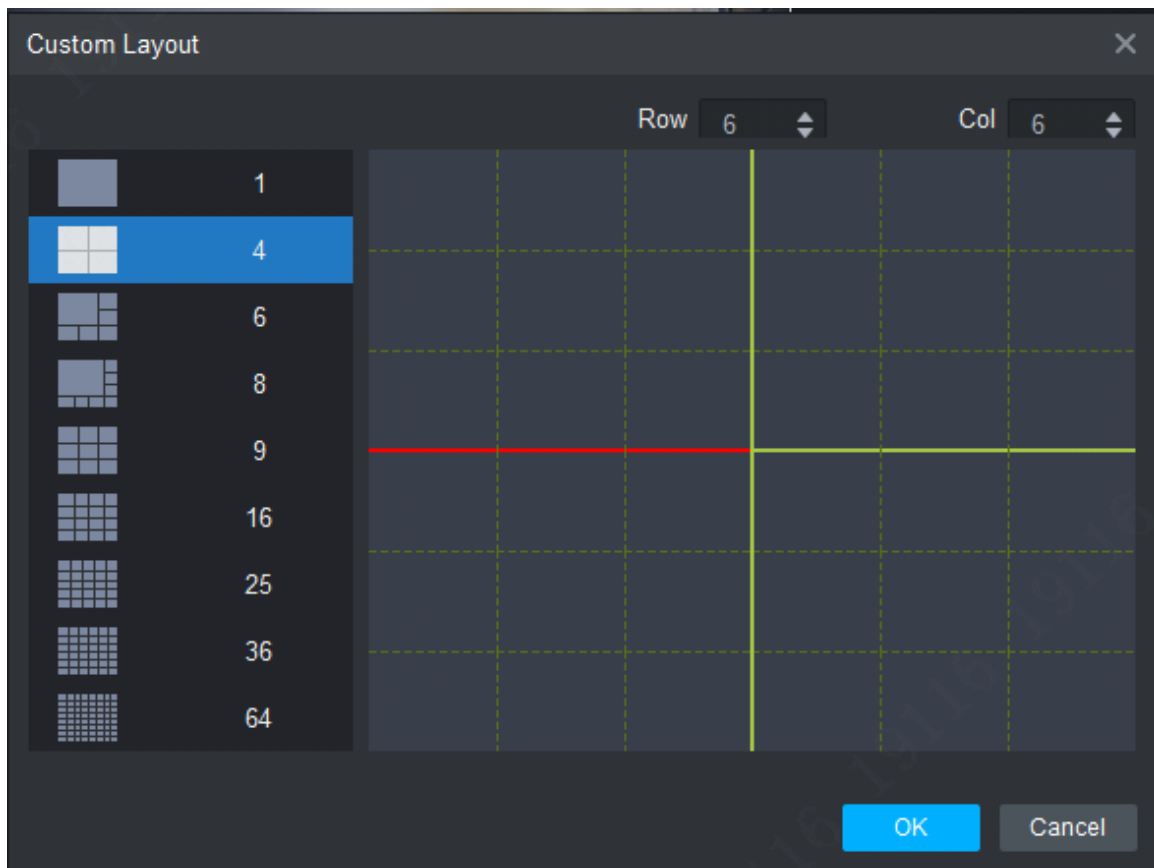

Figure 4-5

4.3 E-Map

Via E-map you may know the location of video channel or alarm channel and live preview.

4.3.1 New Map

Step 1. Right click group in Organization Tree, select New Map. See Figure 4-6.

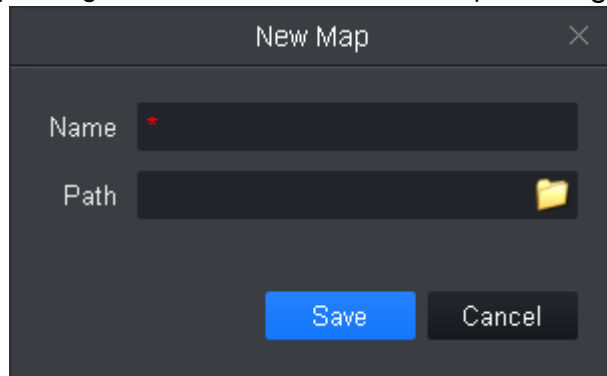

Figure 4-6

Step 2. Set map name, select path of picture.

Step 3. Click Save. See Figure 4-7.

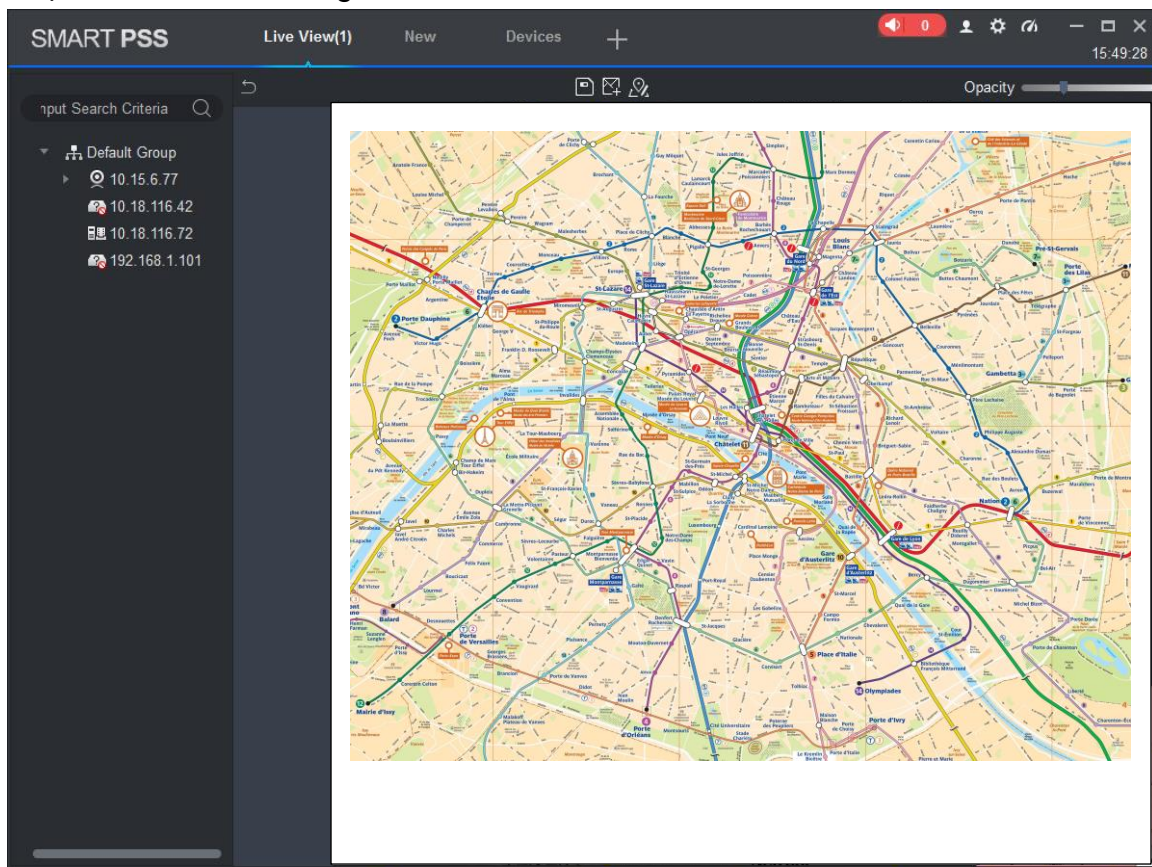

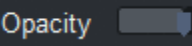



Figure 4-7

Note:

- Click , create new hot zone on map.
- Click , modify map name or replace map.

- Click  to adjust opacity.
- At the lower right corner, user may see aerial view of map. Click , to close aerial view and click  to open aerial view.

Step 4. Drag camera to corresponding monitor position on map to adjust camera monitor range, or drag camera alarm input into map. See Figure 4-8.

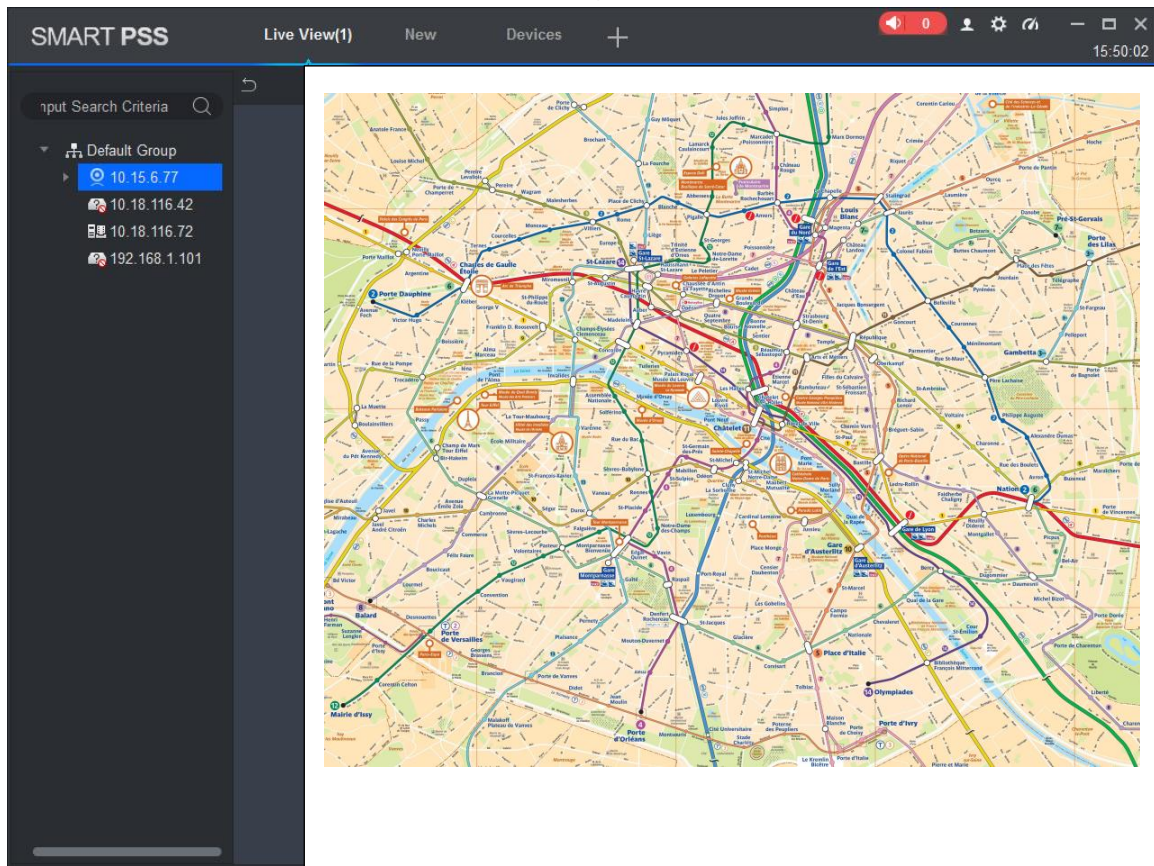

Figure 4-8

Step 5. Add new hot zone.

1. In e-map interface, click . See Figure 4-9.

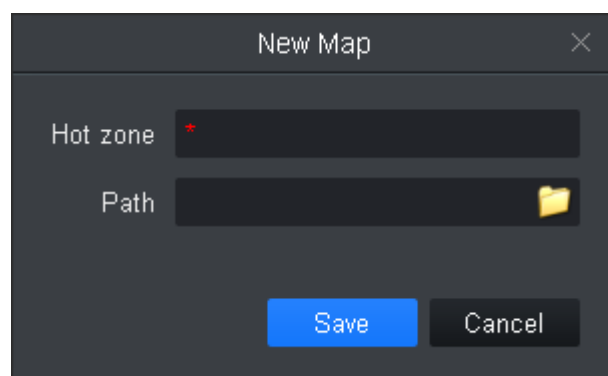

Figure 4-9

2. Set map name, select picture path. Click Save.
3. Double click hot zone, map switch to hot zone map, see Figure 4-10.

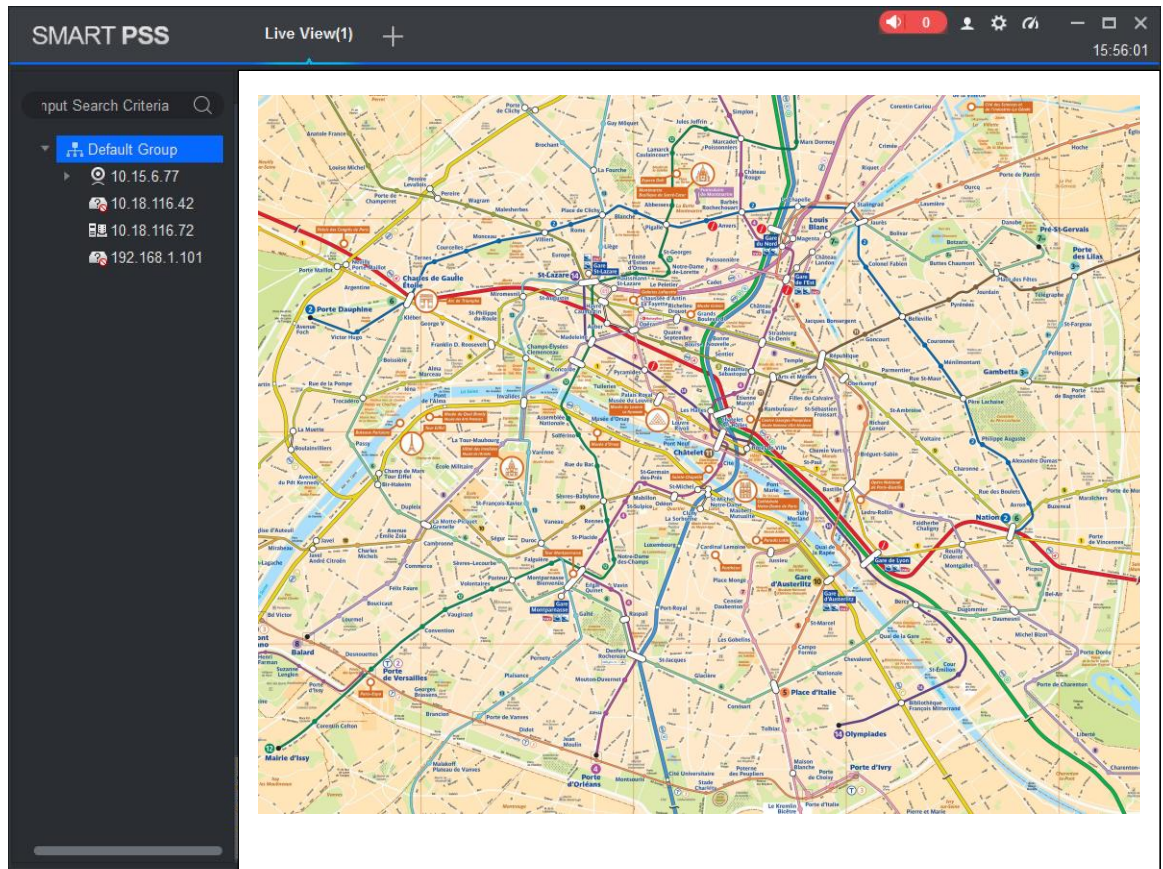



Figure 4-10

Note:

On map, click picture window at the lower-left corner, user may return to map or previous level of hot zone.

4. Drag device in list to map, and adjust camera monitoring range.

Step 6. Click  to save map. After config is complete, it shows created map and hot zone in it, see Figure 4-11.

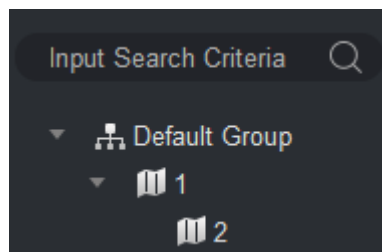

Figure 4-11

4.3.2 Preview Map or Hot Zone

It supports to add camera on map or hot zone, and here uses hot zone as an example.

Step 1. Open Live interface, in device list double click heat map or drag heat map into preview window.

Step 2. On map click camera or place mouse on camera for a few seconds, in the pop-up window user may view live preview.

Note:



- In hot zone preview window, click , to return to map preview.
- If current preview is map, double click hot zone mark on it to enter hot zone.
- Click hot zone preview window, right click and select Open All Channels, at bottom of preview window it shows live of all devices.
- Right click Video Wall, and in pop-up window it shows live of all devices.

4.4 Config IVS Channel

IVS includes general behavior analytics, face recognition, people count, heat map and etc., different devices support different IVS plans, which subject to actual interface.

In Live View interface, right click device in list, select IVS channel cfg, see Figure 4-12.

Note:

- IVS analytics only detects IVS analytics capacity of connected device.
- Speed dome or PTZ device support scene config and preset selection, IPC do not support scene config.
- Set IVS analytics refer to continuous setup in this chapter.
- If you need a static scene, user may click  to stop video; click  to continue playing.

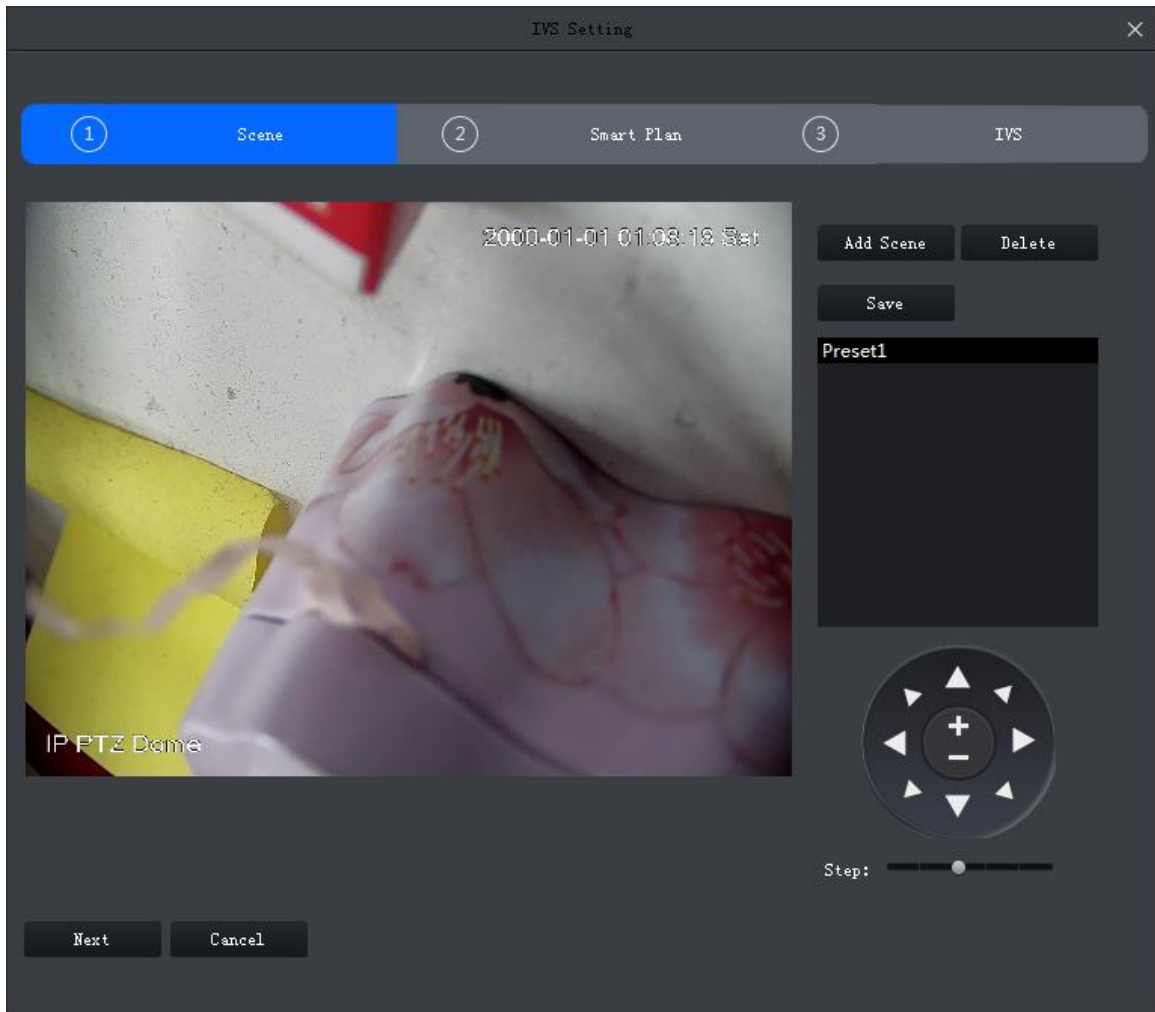

Figure 4-12

4.4.1 Scene Config

For example to device to add is speed dome or PTZ device, then it supports to set preset in scene config interface, and user may set different plans for preset.

Add Preset

Step 1. In Scene interface, click Add Scene, see Figure 4-13.

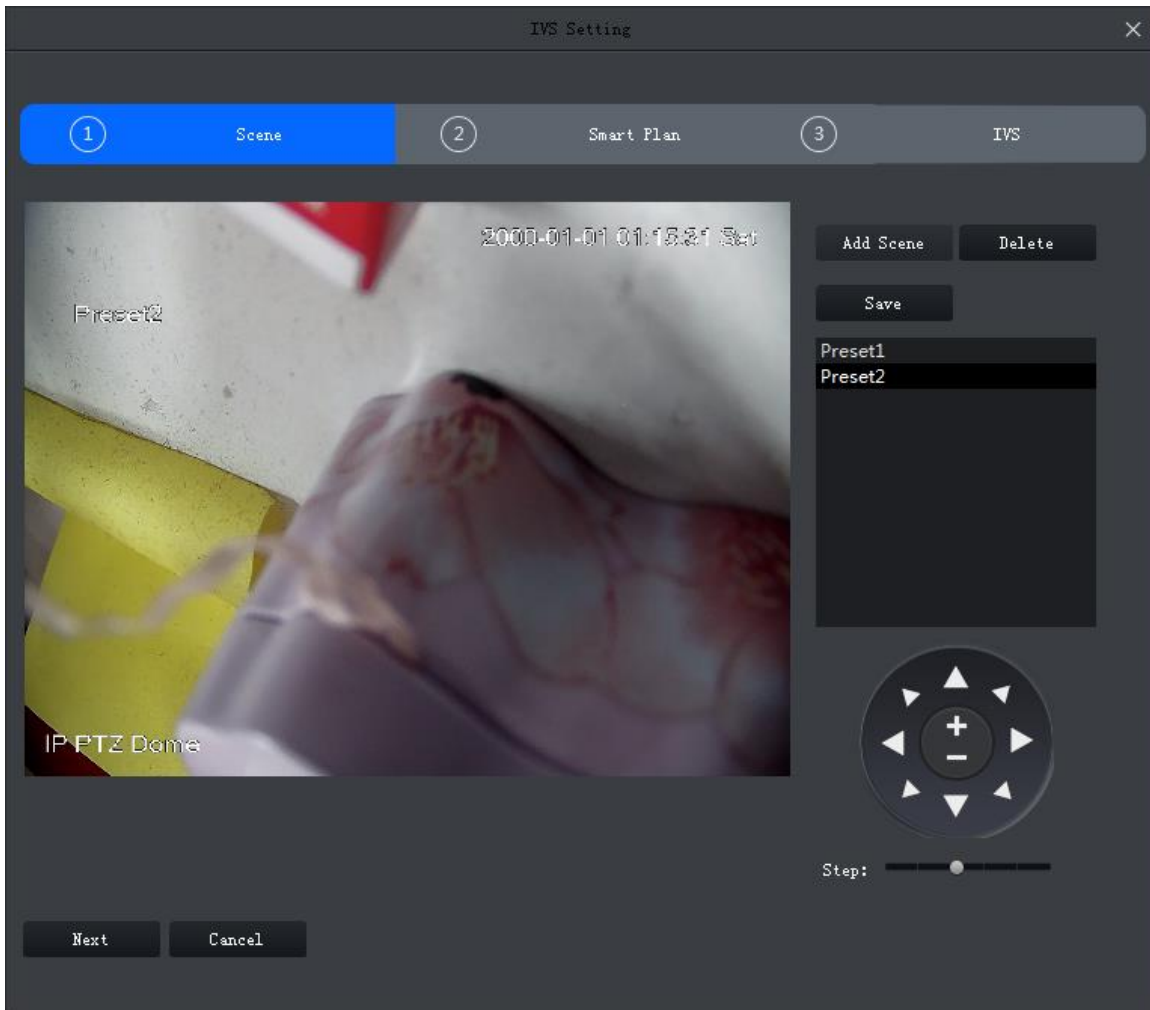

Figure 4-13

Step 2. Via PTZ direction control, rotate camera to designated position.

Note:

Step length can control PTZ speed, within 1~8 step length.

Step 3. Click Save.

Modify Preset

Step 1. In Scene interface, select preset to modify, see Figure 4-13.

Step 2. Via PTZ direction control, rotate camera to designated position.

Note:

Step length can control PTZ speed, within 1~8 step length.

Step 3. Click Save.

Delete Preset

Step 1. In Scene interface, select preset to delete, see Figure 4-13.

Step 2. Click Delete.

4.4.2 General Behavior Analytics

After you enable behavior analytics, user may tripwire, perimeter protection and etc. Subject to actual front-end device.

4.4.2.1 Enable Behavior Analytics

Step 1. In Scene interface, when preset setup is complete, click Next. See Figure 4-14.

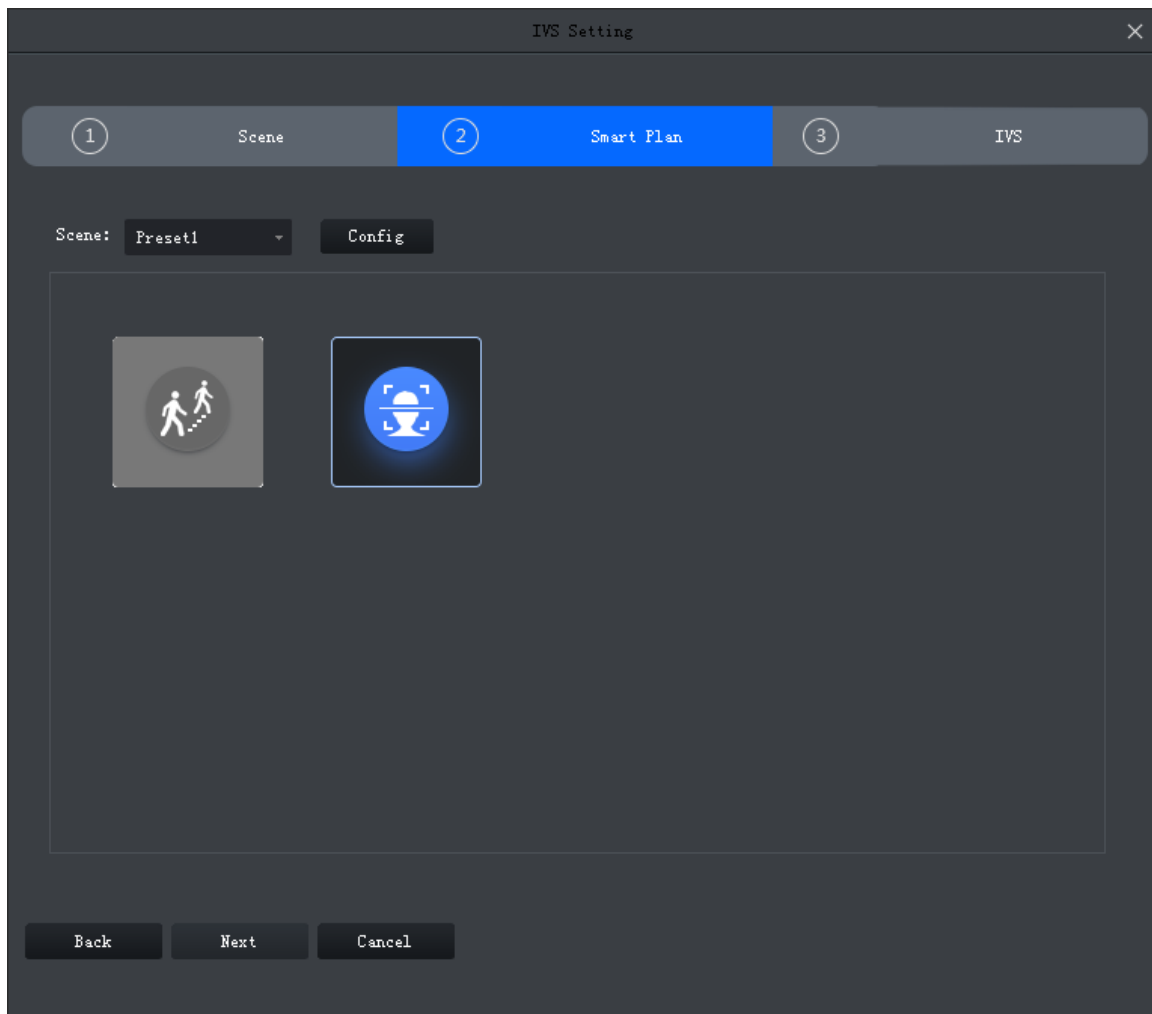

Figure 4-14

Step 2. Select scene.

Step 3. Click  and select IVS plan.

4.4.2.2 Calibration

According to user marked 1 horizontal line and 3 vertical lines, and corresponding actual distance, it can estimate internal parameter and external parameter in order to confirm relationship between gotten 2D image and 3D actual object.

Step 1. In Smart Plan interface select plan and click Next or config, see Figure 4-15.

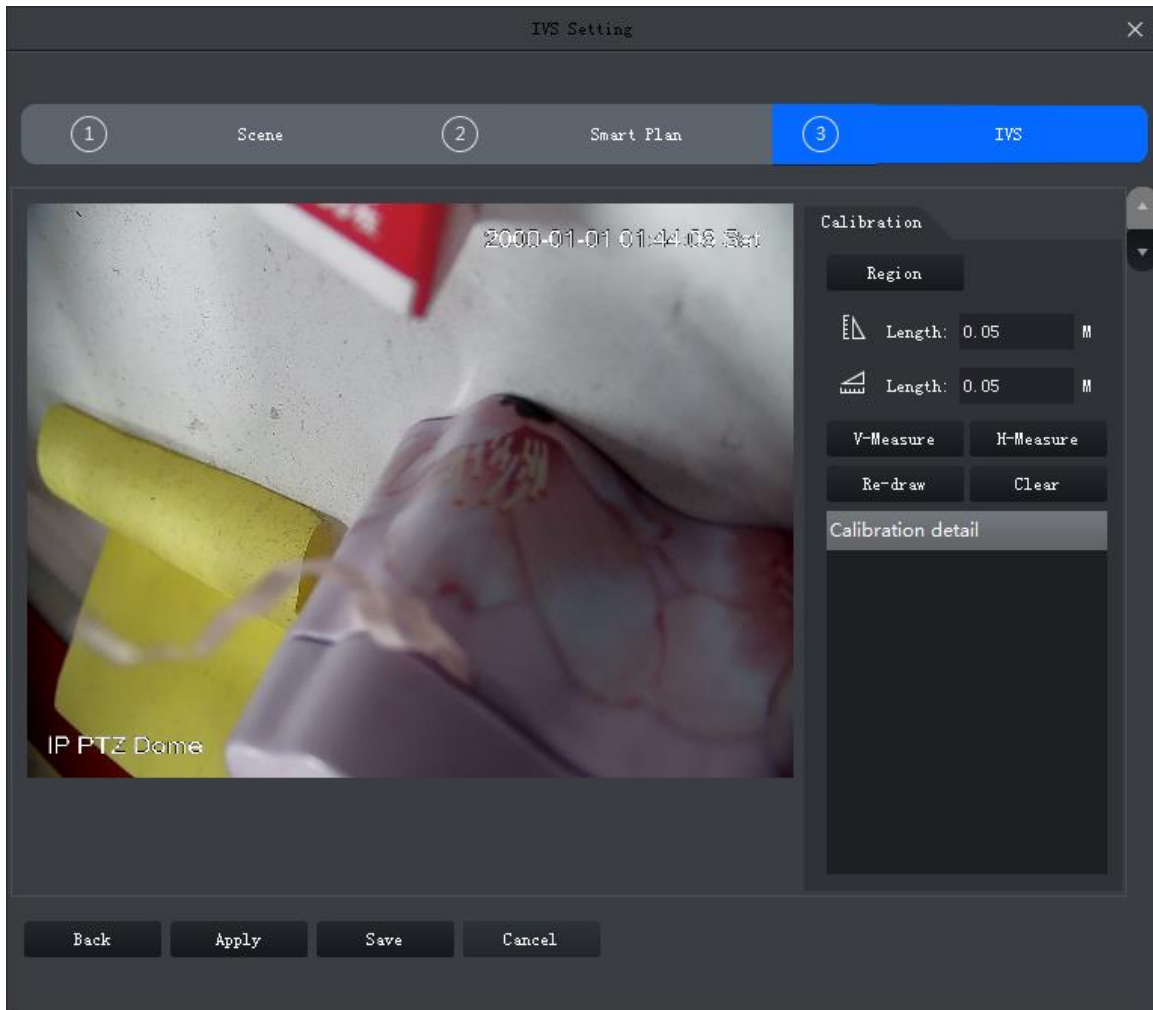



Figure 4-15

Step 2. Click Region, and draw region in window, when you complete, right click to end.

Step 3. Set ruler length, click . Draw vertical rule and left click to end drawing.

Repeat this step to draw 3 vertical rulers. Shape of triangle is recommended.

Step 4. Set horizontal rule angle, click , and draw 1 horizontal line in region, left click to end.

Note:

- Select vertical or horizontal rule, click redraw to draw rule. Select region, click redraw is you want to draw again region, vertical ruler and horizontal ruler.
- Select vertical or horizontal ruler, click Delete to delete ruler. Select region, click Delete to delete region, vertical ruler and horizontal ruler together.

Step 5. Click Apply to save.

Step 6. (Optional) vertically or horizontally measure distance.

- Click V-measure, and draw vertical line in region, system shows all drawn vertical line length.
- Click H-measure, and draw horizontal line in region, system shows all drawn horizontal line length.

4.4.2.3 Set Detection Zone

User may set region of IVS analysis.

Step 1. Click . See Figure 4-16.

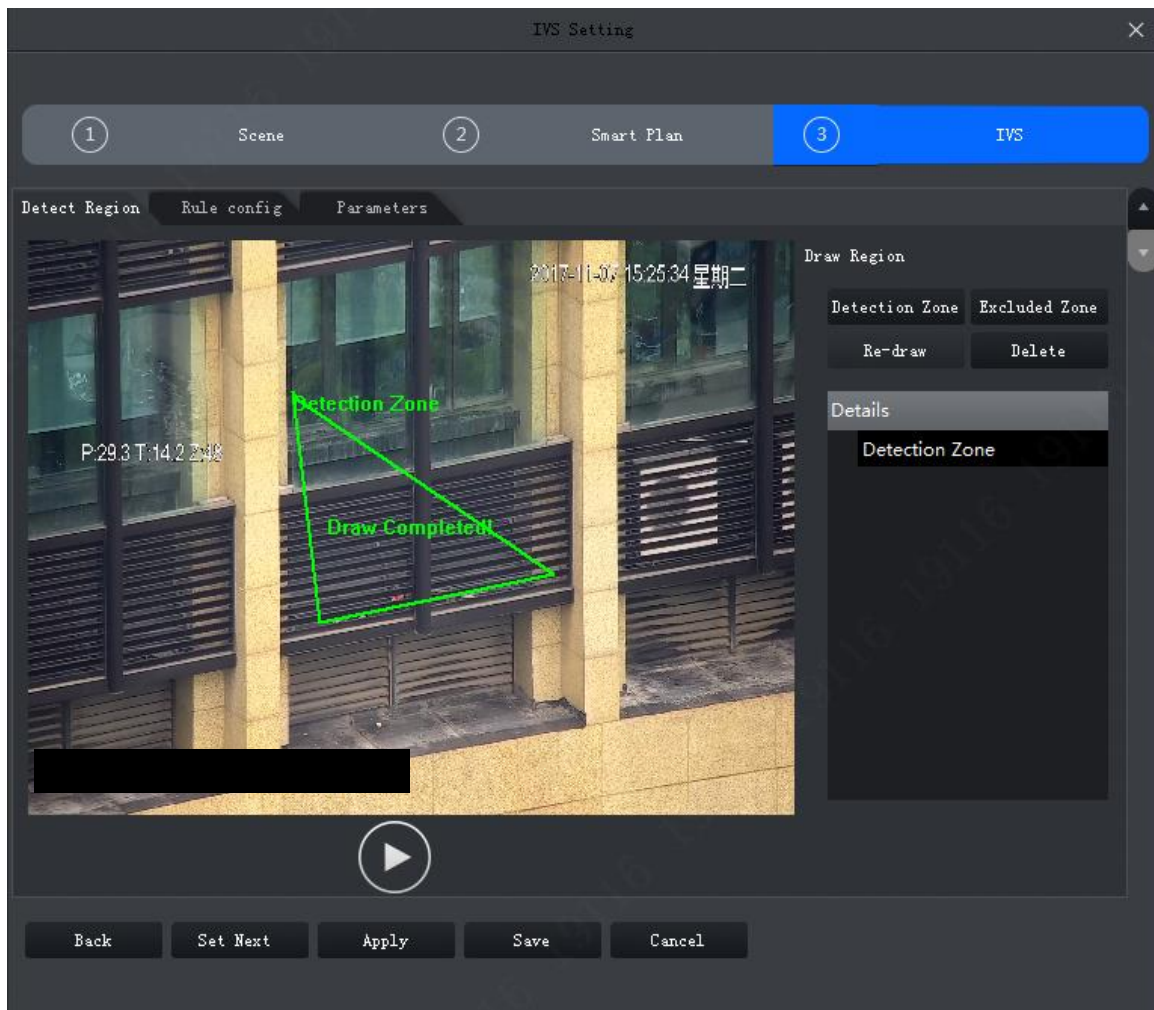

Figure 4-16

Step 2. Click Detection Zone, in video window, draw detection zone and right click to stop drawing.

Step 3. Click Excluded Zone, in detection zone draw excluded zone, and right click to stop drawing.

Note:

- Select excluded zone, click Re-draw to draw again. Selected detection, click Re-draw to redraw detection and excluded zone.
- Select excluded zone, click Delete to delete zone. Selected detection, click Delete to delete detection and excluded zone.

4.4.2.4 IVS Rule

Here user may set IVS rule.

In Smart Plan interface, select Next or config, see Figure 4-17.

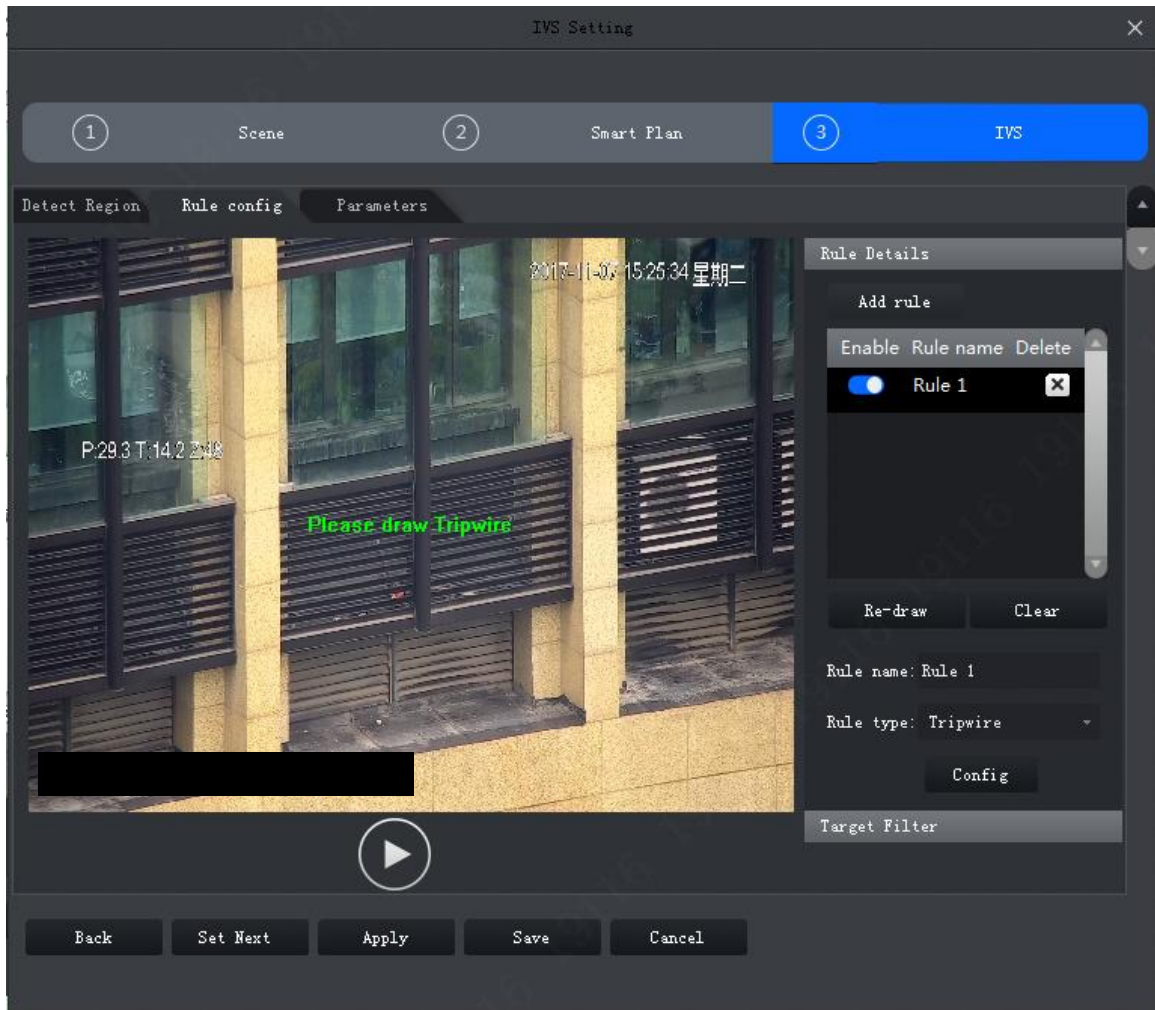

Figure 4-17

4.4.2.4.1 Crossing Virtual Fence

When a target crosses upper and lower fences, alarm is triggered.

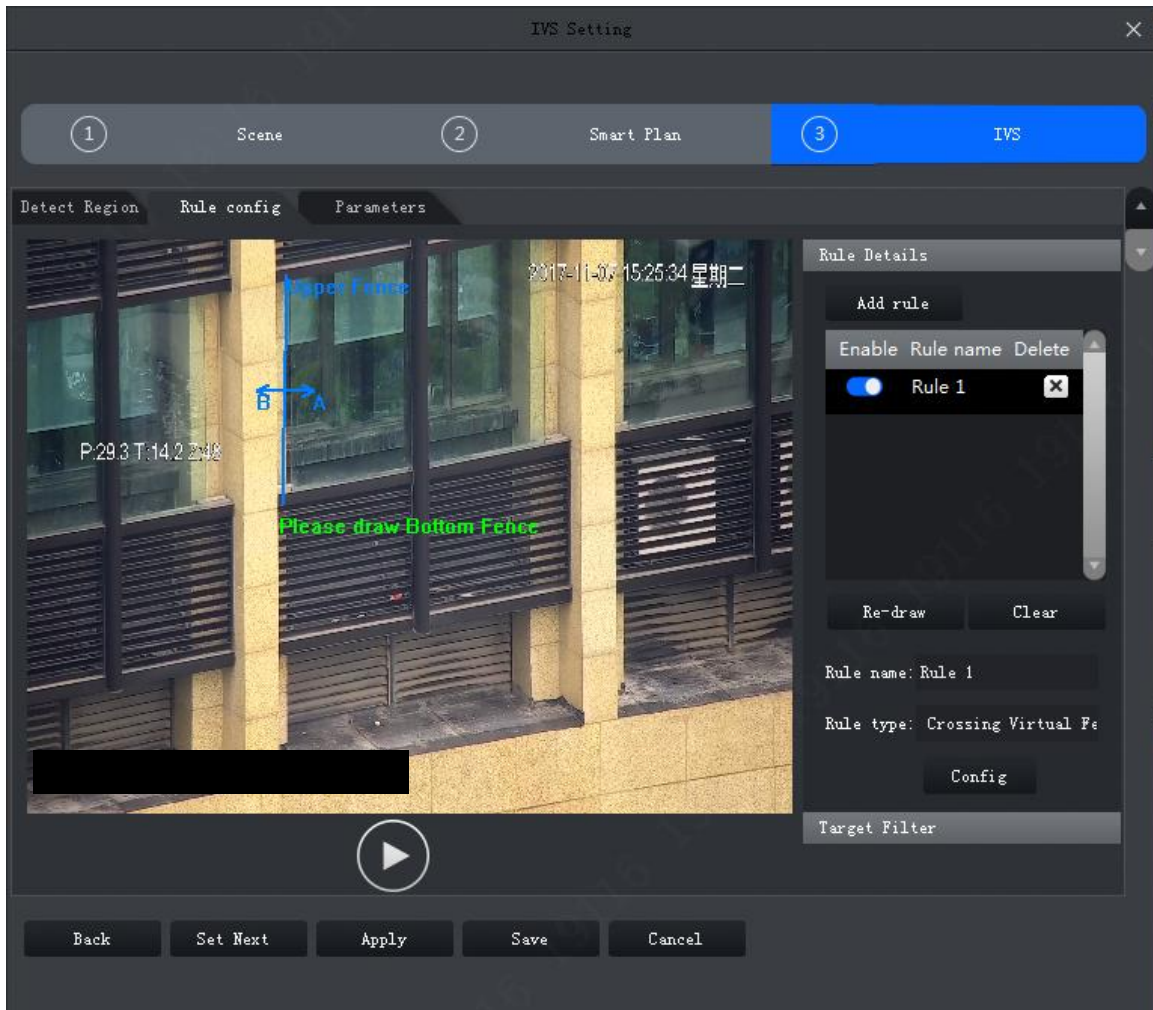



Figure 4-18

Step 1. Click Add rule.

Step 2. Enable rule and modify rule name and type.

1. Enable rule,  means to enable corresponding IVS rule.
2. Modify rule name.
3. In Rule type dropdown list, select Crossing virtual fence.

Step 3. In monitoring video, draw fence, and right click to stop drawing.

Note:

- In drawing status, click Clear to delete existing fence.
- Select upper or lower fence, click Re-draw to draw again.

Step 4. Set parameter, arm time and alarm link.

1. Click Config, set parameter, see Figure 4-19. See Chart 4-3.

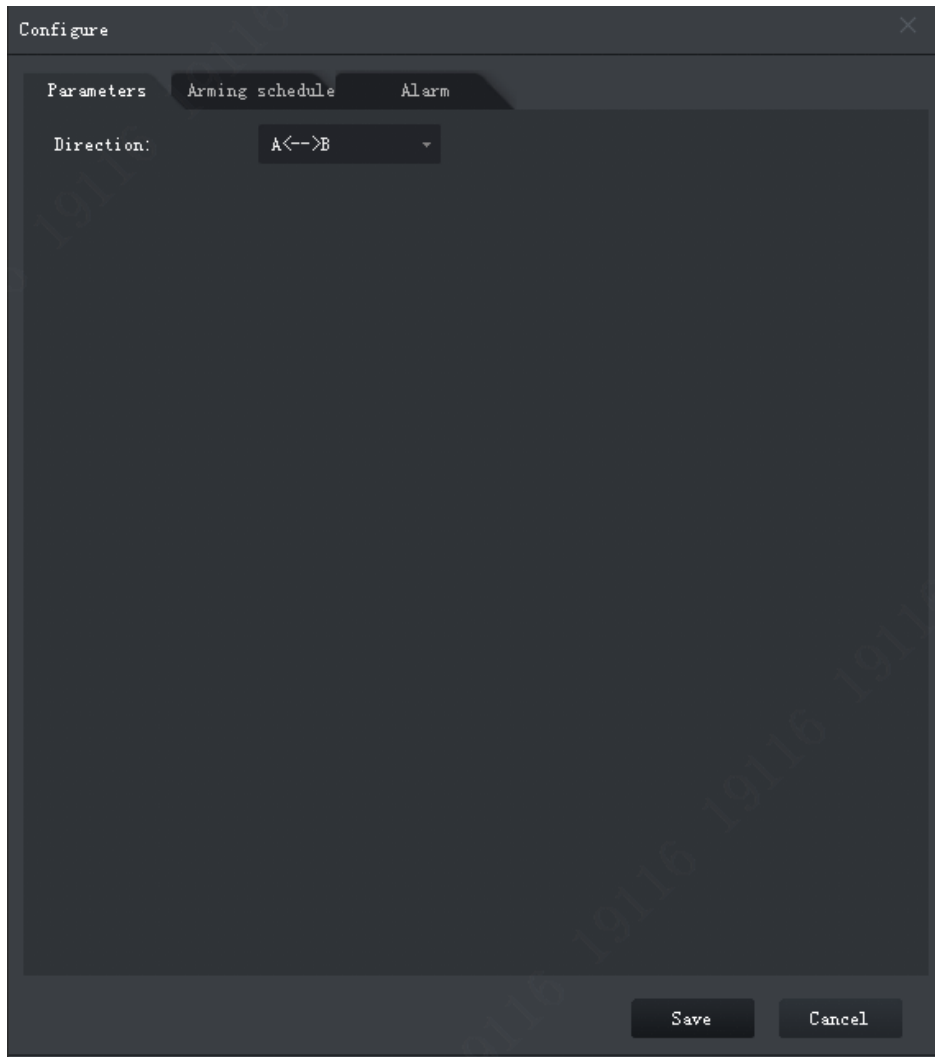

Figure 4-19

| Parameter | Note |
|-----------|--|
| Direction | Movement of target and setup direction are the same, as intrusion. It supports setup direction of A→B, B→A, A↔B. |

Chart 4-3

2. Click Arming Schedule, select week and period, enter start time and end time. See Figure 4-20.

Note:

Default is 24-hour every day.

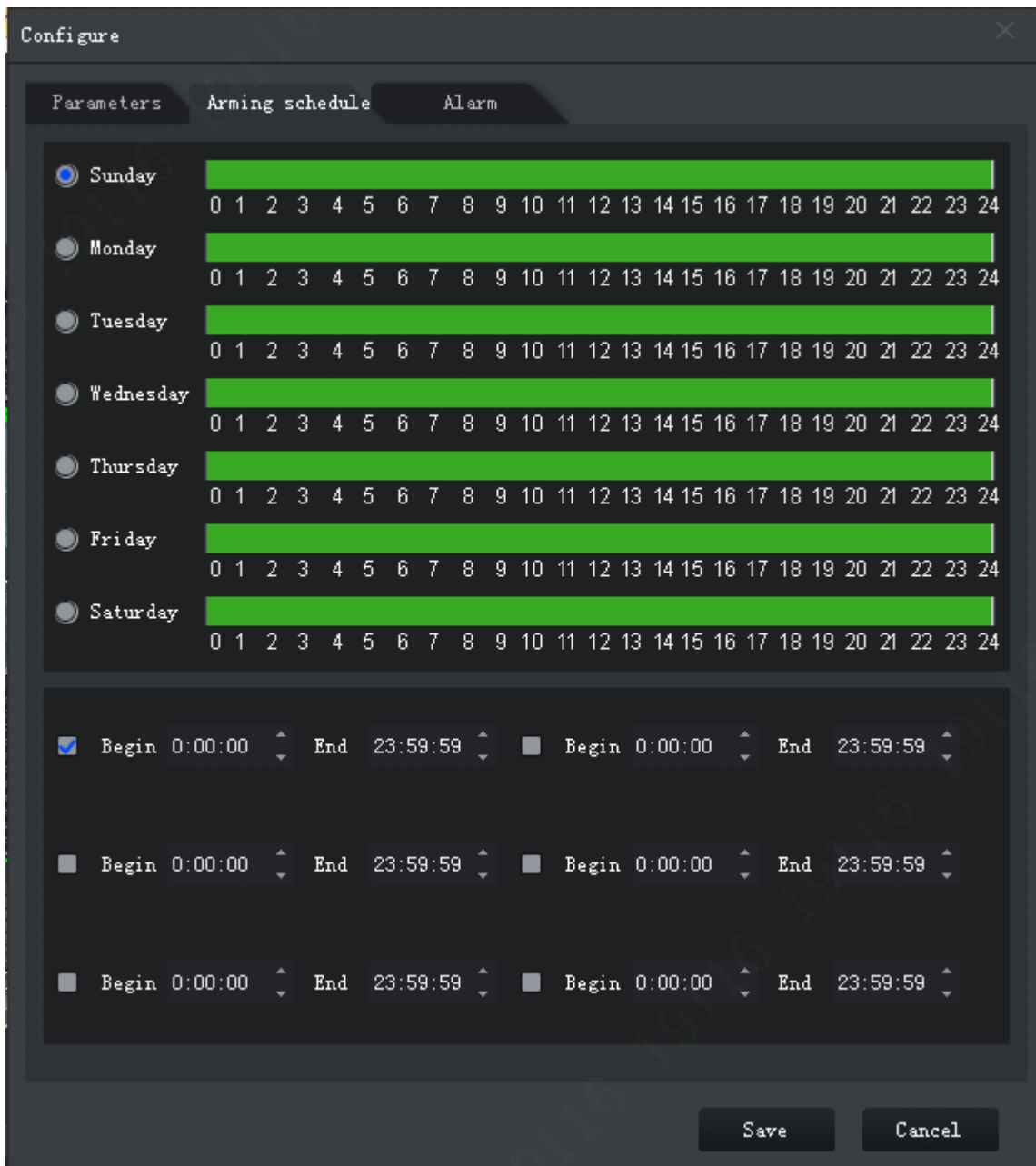

Figure 4-20

3. Click Alarm tab, set link, see Figure 4-21.

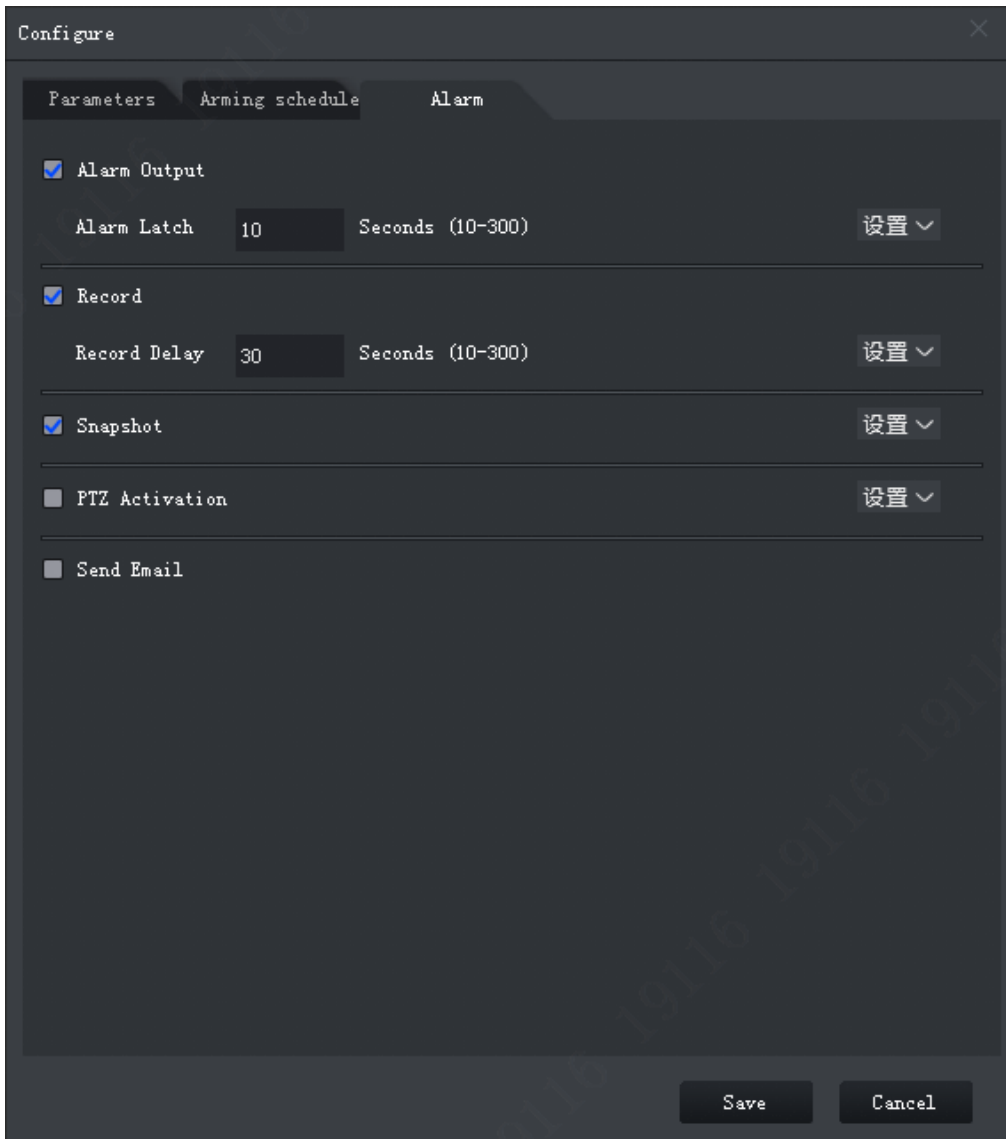

Figure 4-21

| Parameter | Note | |
|--------------|--|---|
| Alarm Output | At alarm output port, connect to device (such as light, siren and etc. When alarm is triggered, system will send alarm info to alarm device. | Click Setup next to alarm latch, and select alarm output channel. |
| Alarm Latch | Alarm will be on for a while after alarm ends. | |
| Record | When alarm is triggered, system auto records. Note: Please enable auto record function, otherwise record will fail. | Click Setup next to record and select record channel. |
| Record Delay | Record will be on for a while after alarm ends. | |
| Snapshot | When alarm is triggered, snapshot. Note: Refer to Ch 8. | Click Setup next to snapshot, user may select snapshot channel. |

| Parameter | Note | |
|----------------|--|--|
| PTZ Activation | When alarm is triggered, link to PTZ. | Click Setup net to PTZ Activation, select activation method, including presser, track and pattern. Meantime input no. correspondingly. |
| Send Email | When face detection alarm occurs, send email to set email aggress. Note: Complete setup of Email, refer to Ch 8. | N/A |

Chart 4-4

4. Click OK to save.

Step 5. Draw target filter box, see Figure 4-22. Filter box is used to filter object that is too big or too small, so only when a target is inside the box, it will alarm.

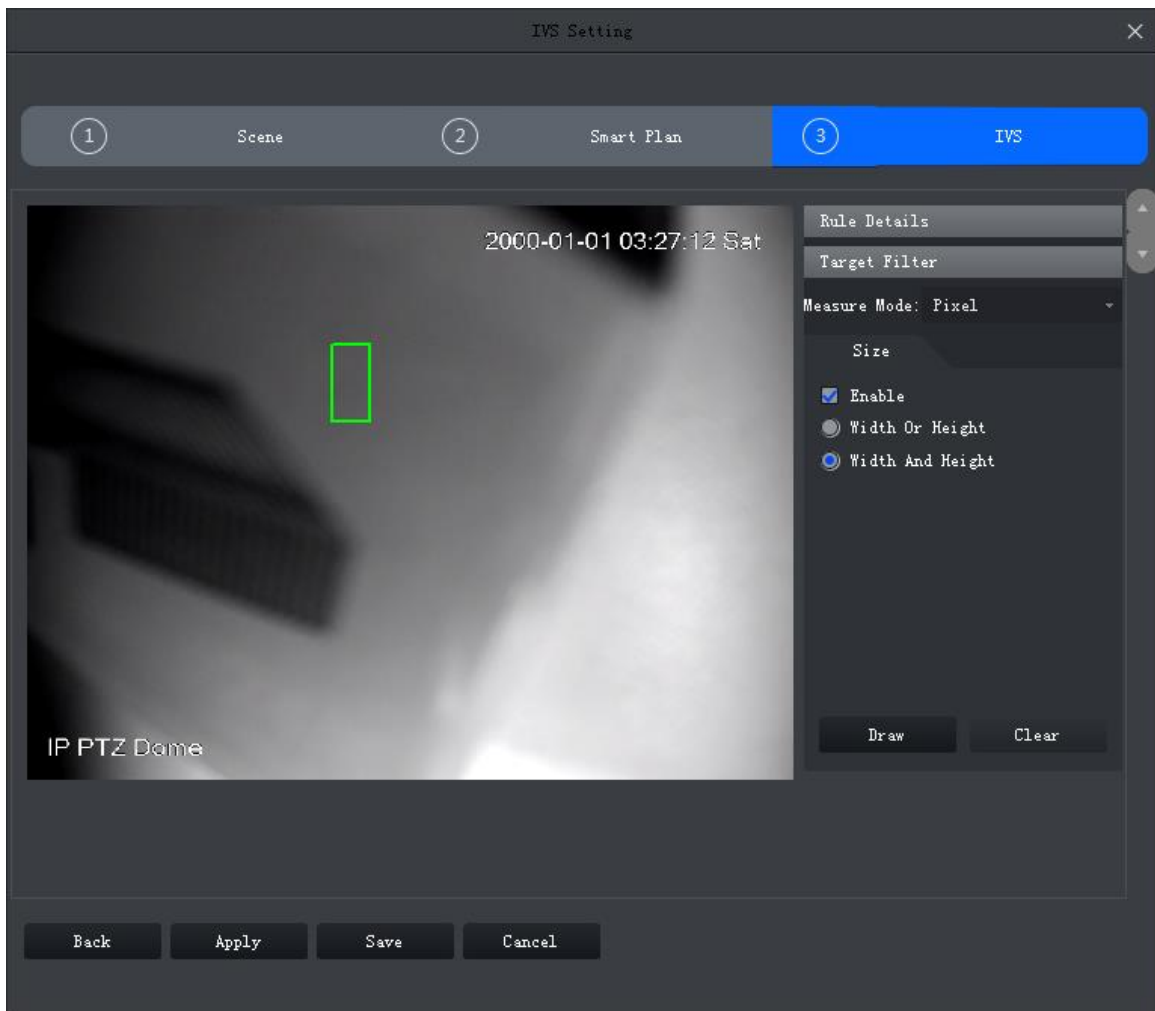

Figure 4-22

1. Select Enable.
2. Select filter method:
 - Width or height, as any of the two factors is matched, target will be kept.
 - Width and height, as both of the two factors are matched, target will be kept.

3. Click Draw, and draw filter box in video window. Select filter box, drag four angles to zoom in or out.

Note:

Select filter box, click Clear to delete box.

Step 6. Click Save.

4.4.2.4.2 Tripwire

When target enters tripwire in set direction, alarm is triggered. See Figure 4-23.

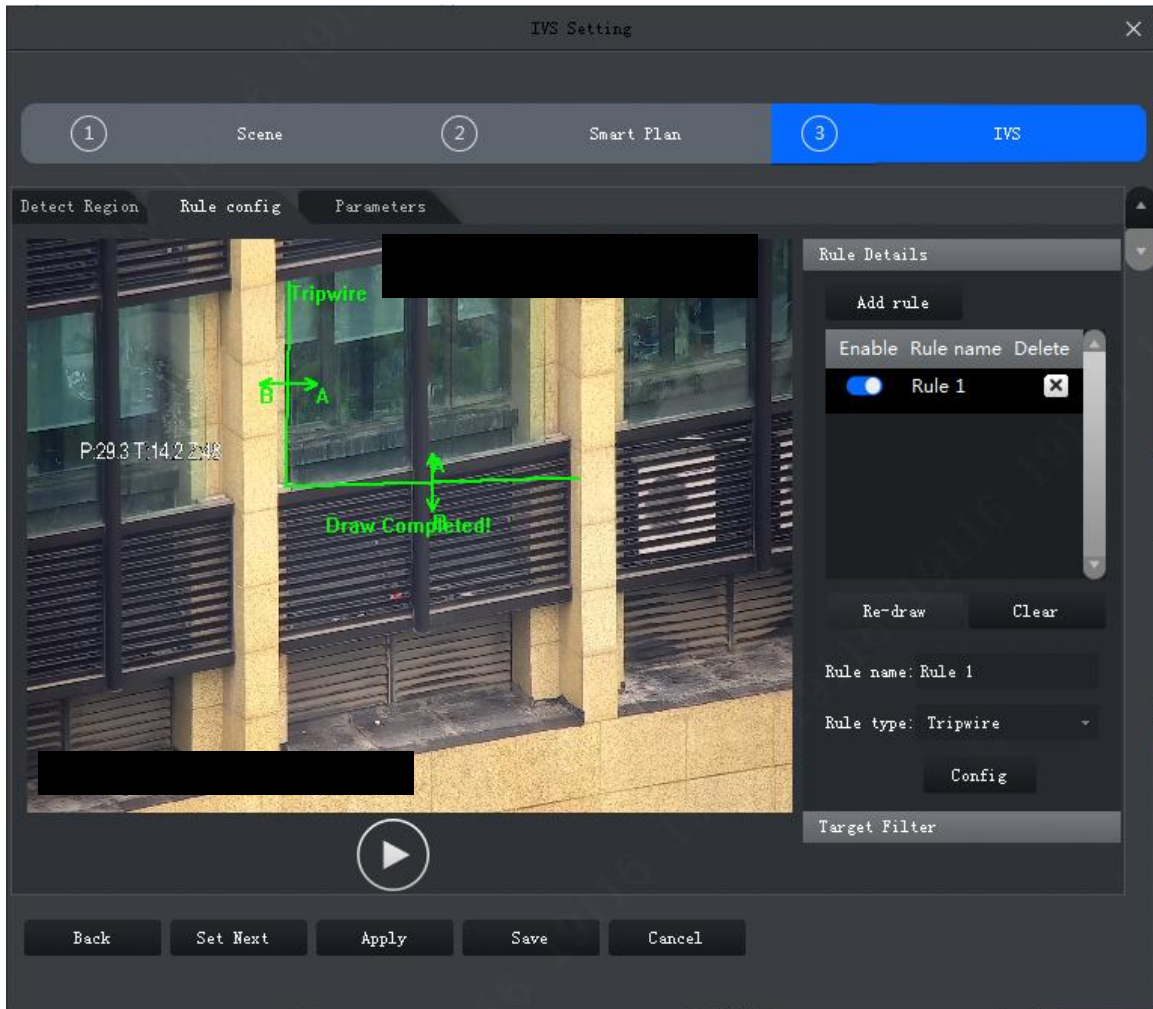



Figure 4-23

Step 1. Click Add rule.

Step 2. Enable rule and modify rule name and type.

1. Enable rule,  means to enable corresponding IVS rule.
2. Modify rule name.
3. In Rule type dropdown list, select Tripwire.

Step 3. In monitoring video, draw tripwire, and right click to stop drawing.

Note:

Select existing tripwire rule, click Clear or Re-draw to draw again.

Step 4. Set parameter, arm time and alarm link. Draw target filter, see Ch 4.4.2.4.1.

5. Click Apply.

4.4.2.4.3 Intrusion

When a target enters, exits or appears in detection zone, alarm is triggered.

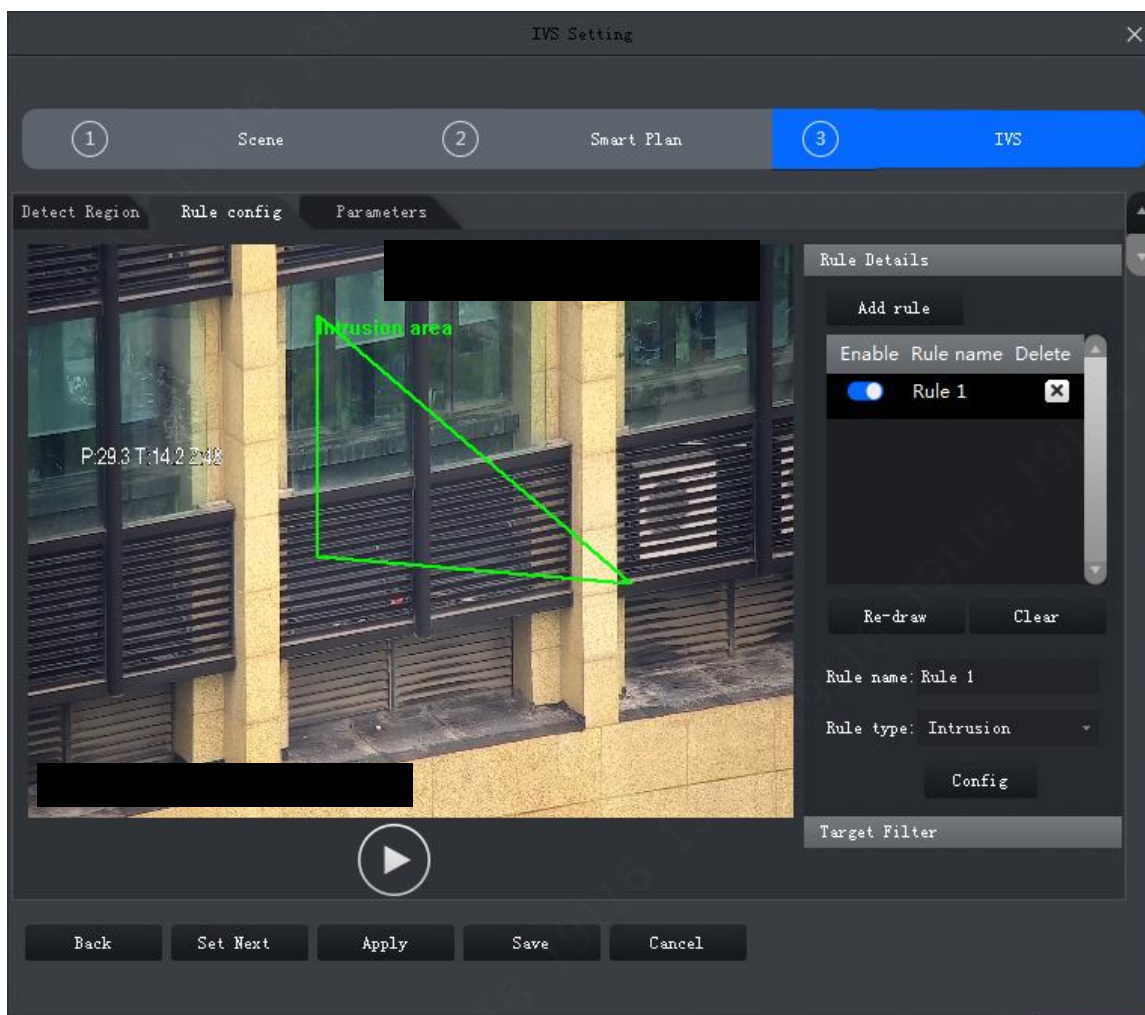



Figure 4-24

Step 1. Click Add rule.

Step 2. Enable rule and modify rule name and type.

1. Enable rule,  means to enable corresponding IVS rule.
2. Modify rule name.
3. In Rule type dropdown list, select Intrusion.

Step 3. In monitoring video, draw detection zone, and right click to stop drawing.

Note:

Select existing detection zone, click Clear or Re-draw to draw again.

Step 4. Set parameter, arm time and alarm link. Draw target filter, see Ch 4.4.2.4.1.

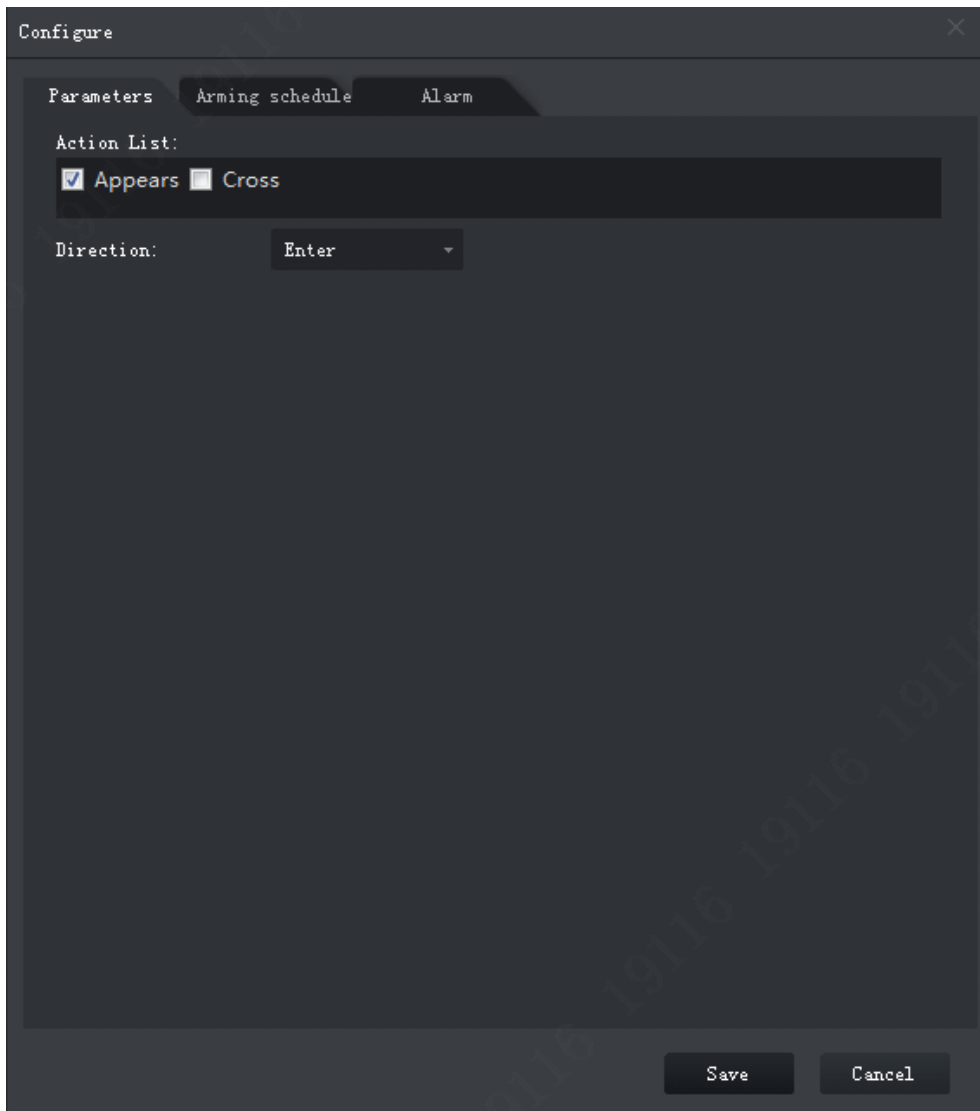

Figure 4-25

| Parameter | Note |
|-------------|---|
| Action List | Include appears zone and cross zone. |
| Direction | When detection action is set to cross, this direction is valid. Direction includes enter, leave and bidirection. |

Chart 4-5

Step 5. Click Apply.

4.4.2.4.4 Abandoned Object

When a target stays in detection zone over a certain period of time, alarm is triggered.

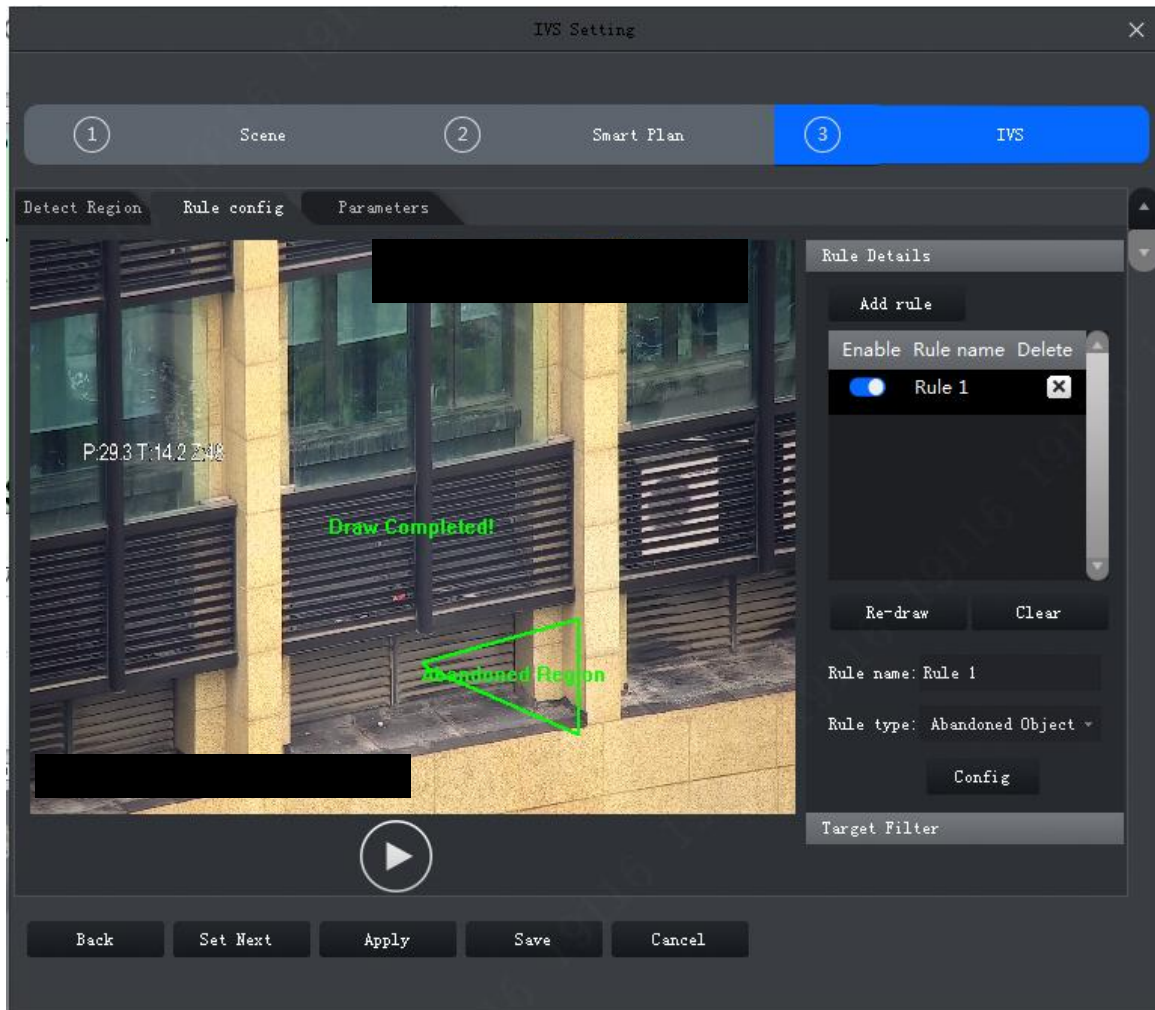



Figure 4-26

Step 1. Click Add rule.

Step 2. Enable rule and modify rule name and type.

1. Enable rule,  means to enable corresponding IVS rule.
2. Modify rule name.
3. In Rule type dropdown list, select Abandoned object.

Step 3. In monitoring video, draw detection zone, and right click to stop drawing.

Note:

Select existing detection zone, click Clear or Re-draw to draw again.

Step 4. Set parameter, arm time and alarm link. Draw target filter, see Ch 4.4.2.4.1.

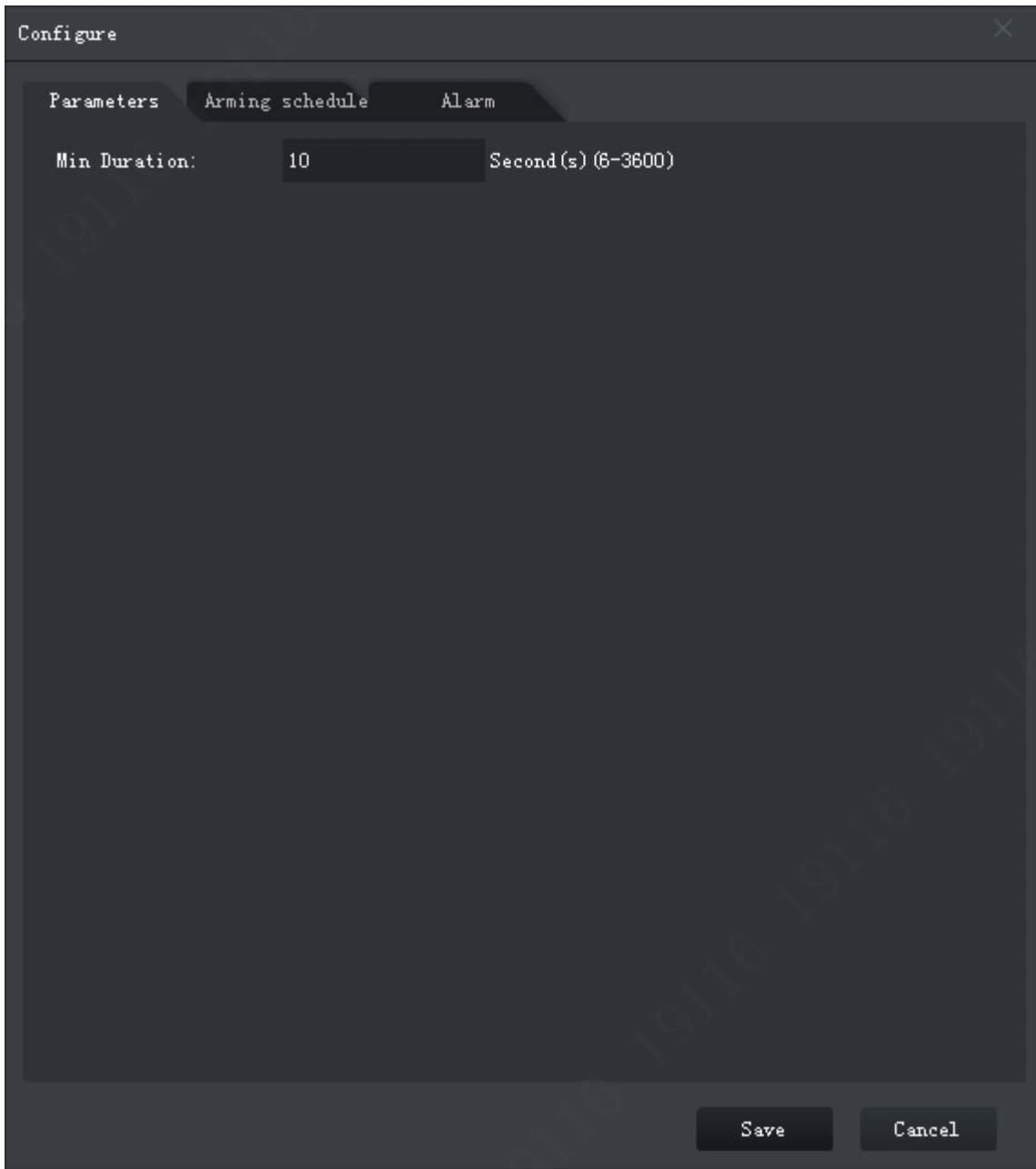

Figure 4-27

| Parameter | Note |
|--------------|---|
| Min Duration | Min duration from a target appears in detection zone to trigger of alarm. |

Chart 4-6

Step 5. Click Apply.

4.4.2.4.5 Fast Moving

When a target moves at speed reaching preset value and duration of movement reaches preset time length, alarm is triggered.

Note:

Only when calibration of global variable is complete, fast moving judgment is accurate, see Ch 4.4.2. 2.

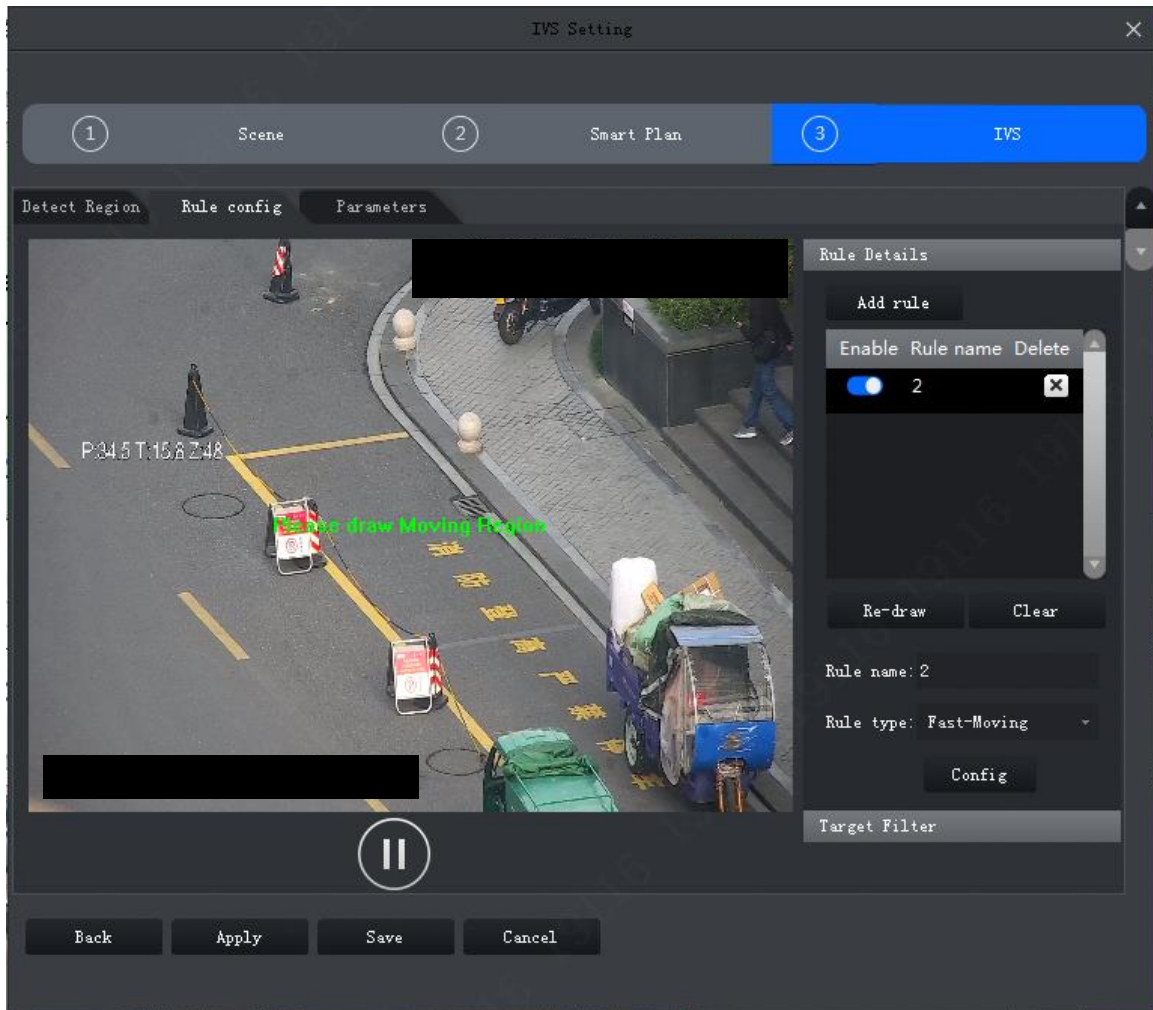



Figure 4-28

Step 1. Click Add rule.

Step 2. Enable rule and modify rule name and type.

1. Enable rule,  means to enable corresponding IVS rule.
2. Modify rule name.
3. In Rule type dropdown list, select Fast-moving.

Step 3. In monitoring video, draw detection zone, and right click to stop drawing.

Note:

Select existing detection zone, click Clear or Re-draw to draw again.

Step 4. Set parameter, arm time and alarm link. Draw target filter, see Ch 4.4.2.4.1.

See Figure 4-29.

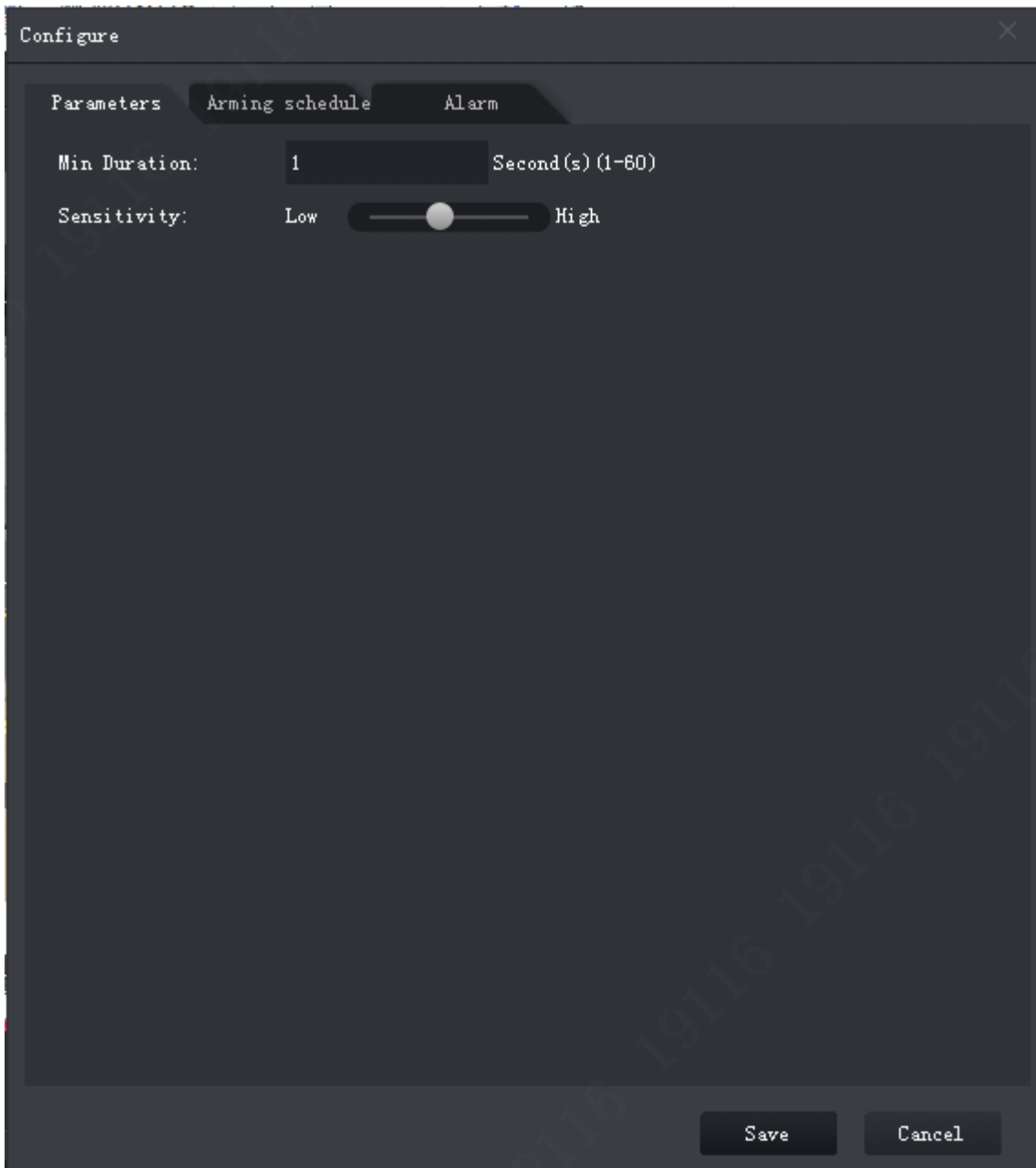

Figure 4-29

| Parameter | Note |
|--------------|--|
| Min Duration | Min duration of target fast moving in detection zone. |
| Sensitivity | The higher the sensitivity is, the easier to trigger alarm while more interference will be caused. Default setup is recommended. |

Chart 4-7

Step 5. Click Apply.

4.4.2.4.6 Parking Detection

When a target parks in detection area over a certain time, alarm is triggered.

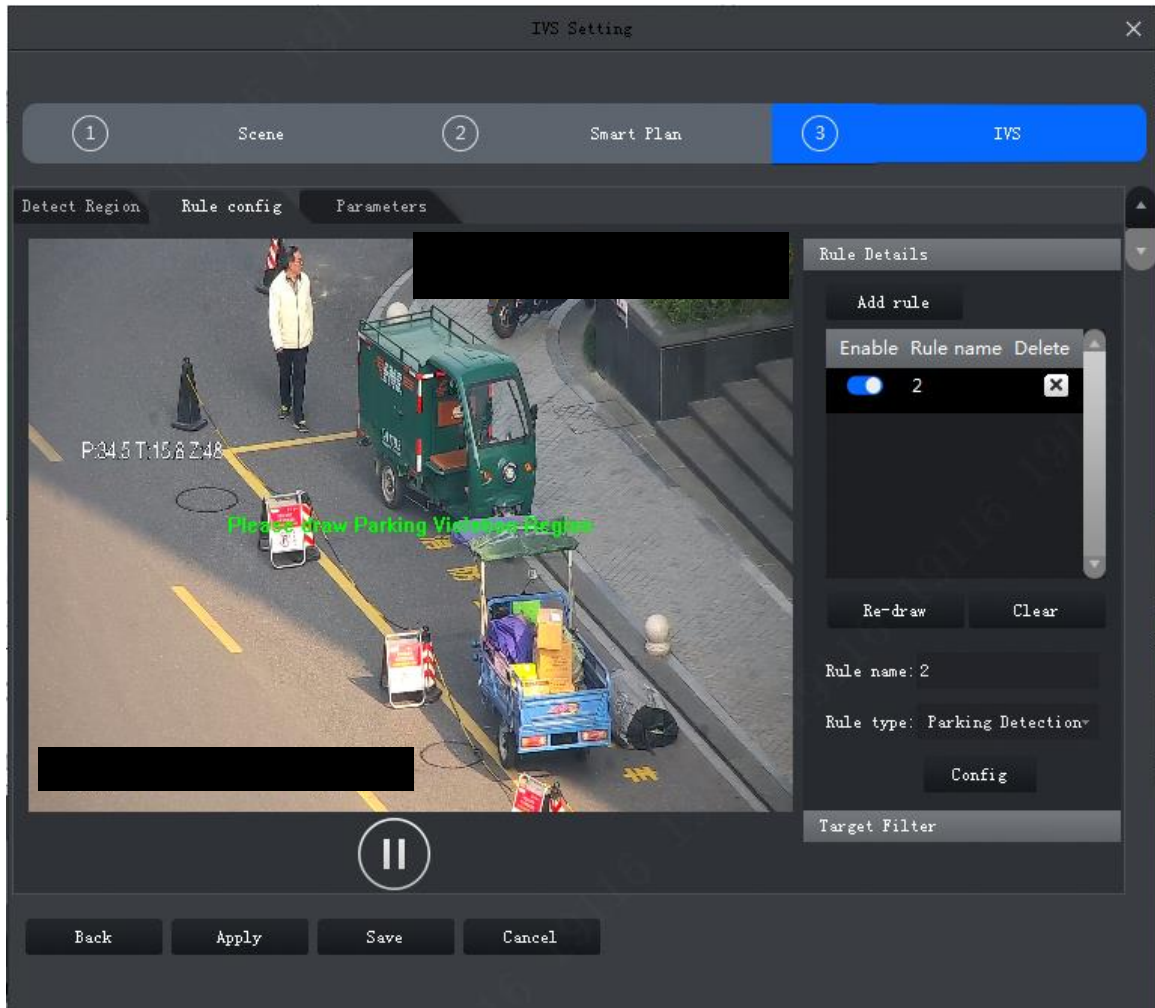



Figure 4-30

Step 1. Click Add rule.

Step 2. Enable rule and modify rule name and type.

1. Enable rule,  means to enable corresponding IVS rule.
2. Modify rule name.
3. In Rule type dropdown list, select Parking detection.

Step 3. In monitoring video, draw detection zone, and right click to stop drawing.

Note:

Select existing detection zone, click Clear or Re-draw to draw again.

Step 4. Set parameter, arm time and alarm link. Draw target filter, see Ch 4.4.2.4.1.

See Figure 4-31.

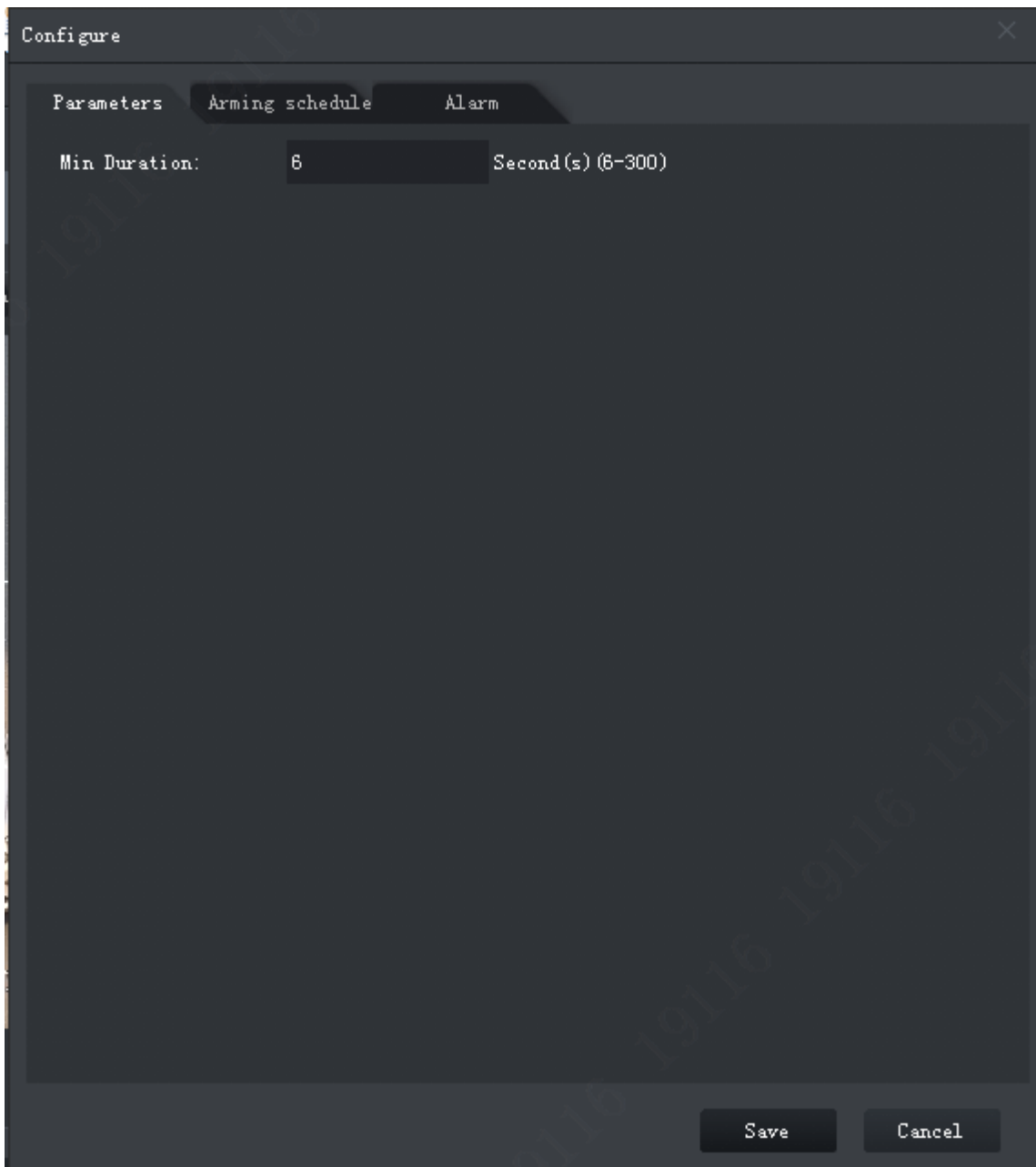

Figure 4-31

| Parameter | Note |
|--------------|---|
| Min Duration | Min time period between target vehicle appearance in detection and alarm trigger. |

Chart 4-8

Step 5. Click Apply.

4.4.2.4.7 Crowd Gathering

When crowd gathers in detection zone and exceeding set quantity of people, alarm is triggered.

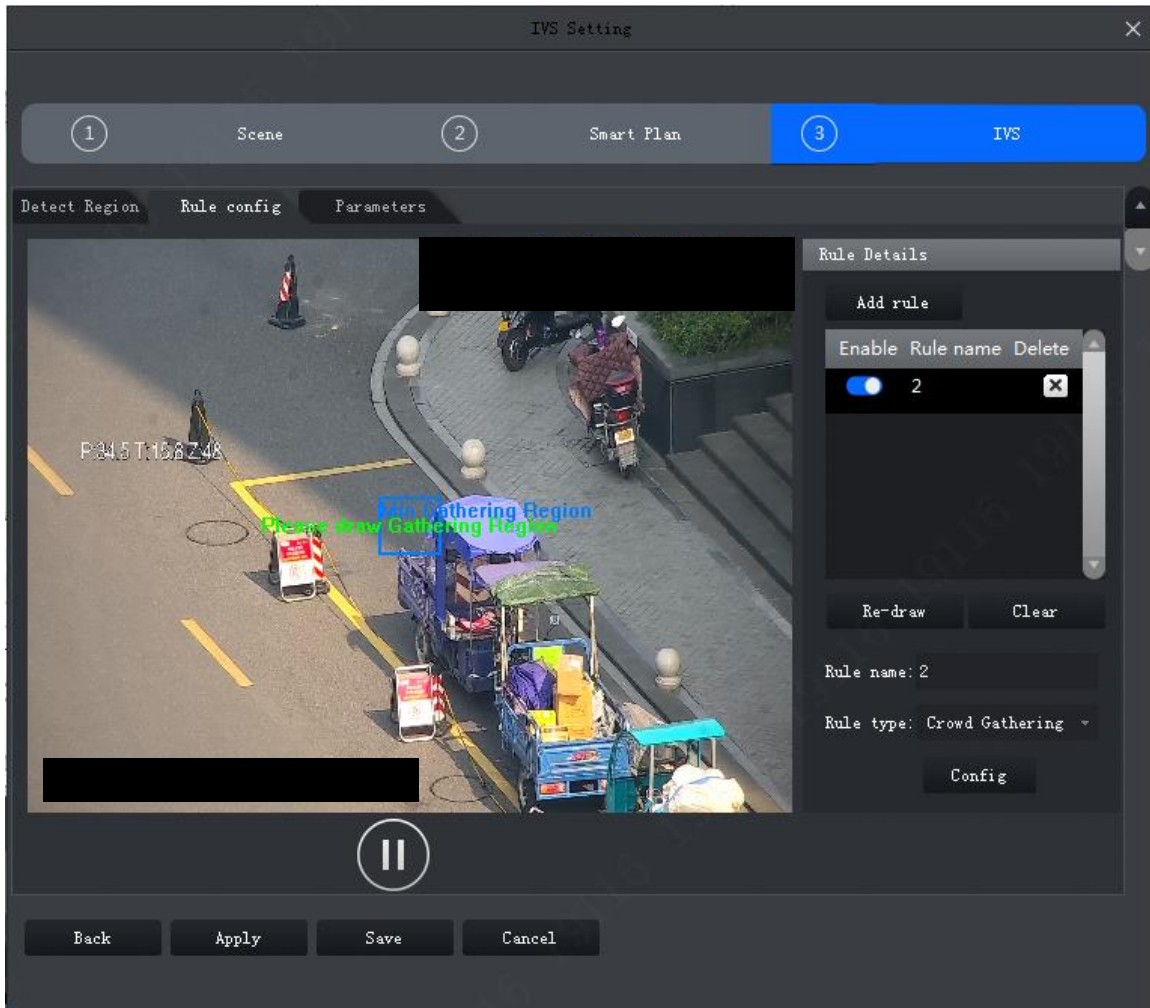



Figure 4-32

Step 1. Click Add rule.

Step 2. Enable rule and modify rule name and type.

1. Enable rule,  means to enable corresponding IVS rule.
2. Modify rule name.
3. In Rule type dropdown list, select Crowding gathering.

Step 3. In monitoring video, draw detection zone, and right click to stop drawing. Click min crowd gathering zone, adjust size by dragging the four angles.

Note:

- Select gathering zone or min gathering zone, click Clear to delete gathering zone and min gathering zone.
- Select gathering zone or min gathering zone, click Re-draw to draw again.

Step 4. Set parameter, arm time and alarm link. Draw target filter, see Ch 4.4.2.4.1.

See Figure 4-33.

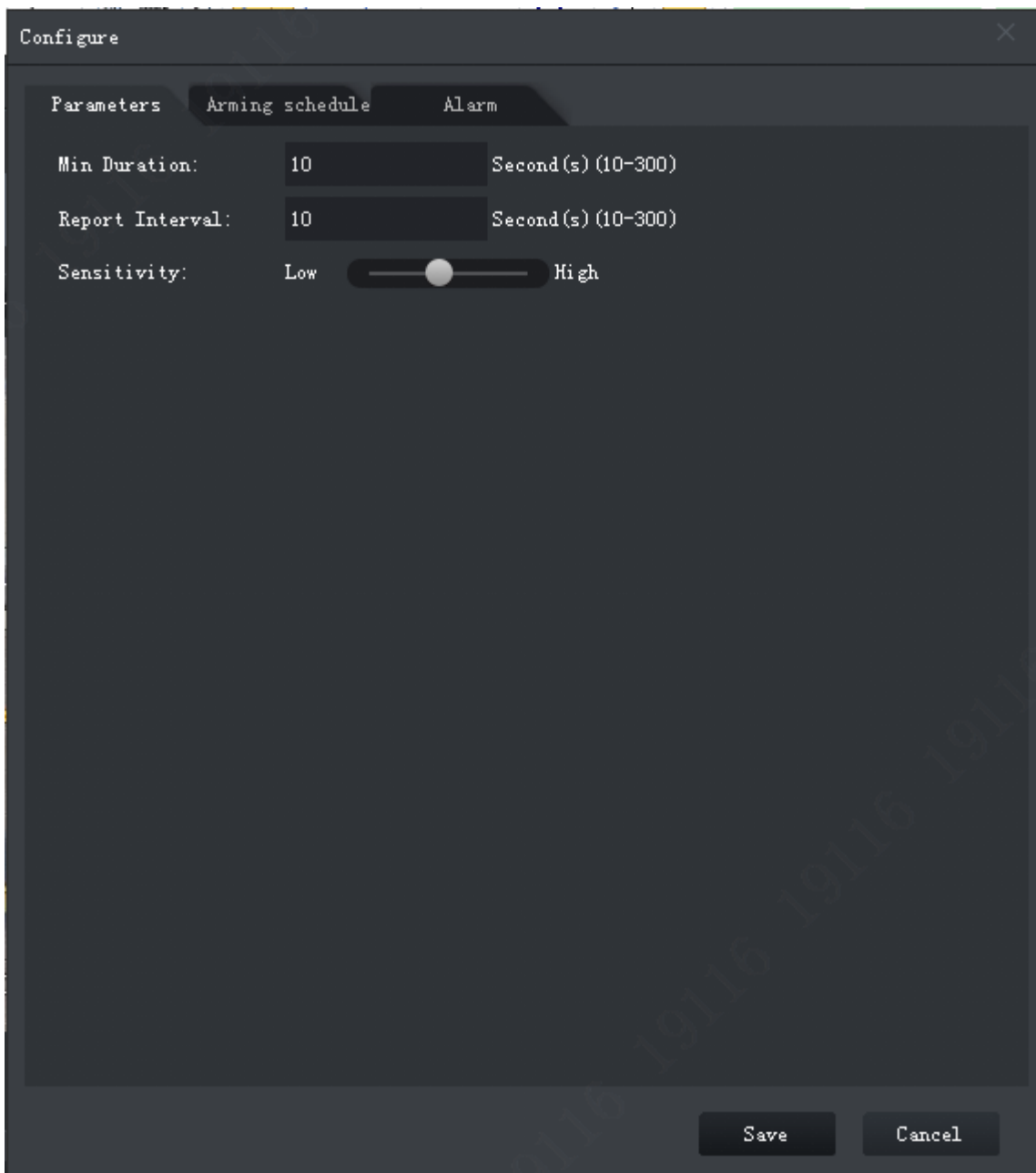

Figure 4-33

| Parameter | Note |
|-----------------|--|
| Min Duration | Min time period between people gathering in detection and alarm trigger. |
| Report Interval | When alarm is triggered, if alarm event still exists, then user may set interval to alarm again and again. |
| Sensitivity | The higher the sensitivity is, the easier to trigger alarm while more interference will be caused. Default setup is recommended. |

Chart 4-9

Step 5. Click Apply.

4.4.2.4.8 Missing Object

When an object is moves out from detection zone, alarm is triggered.

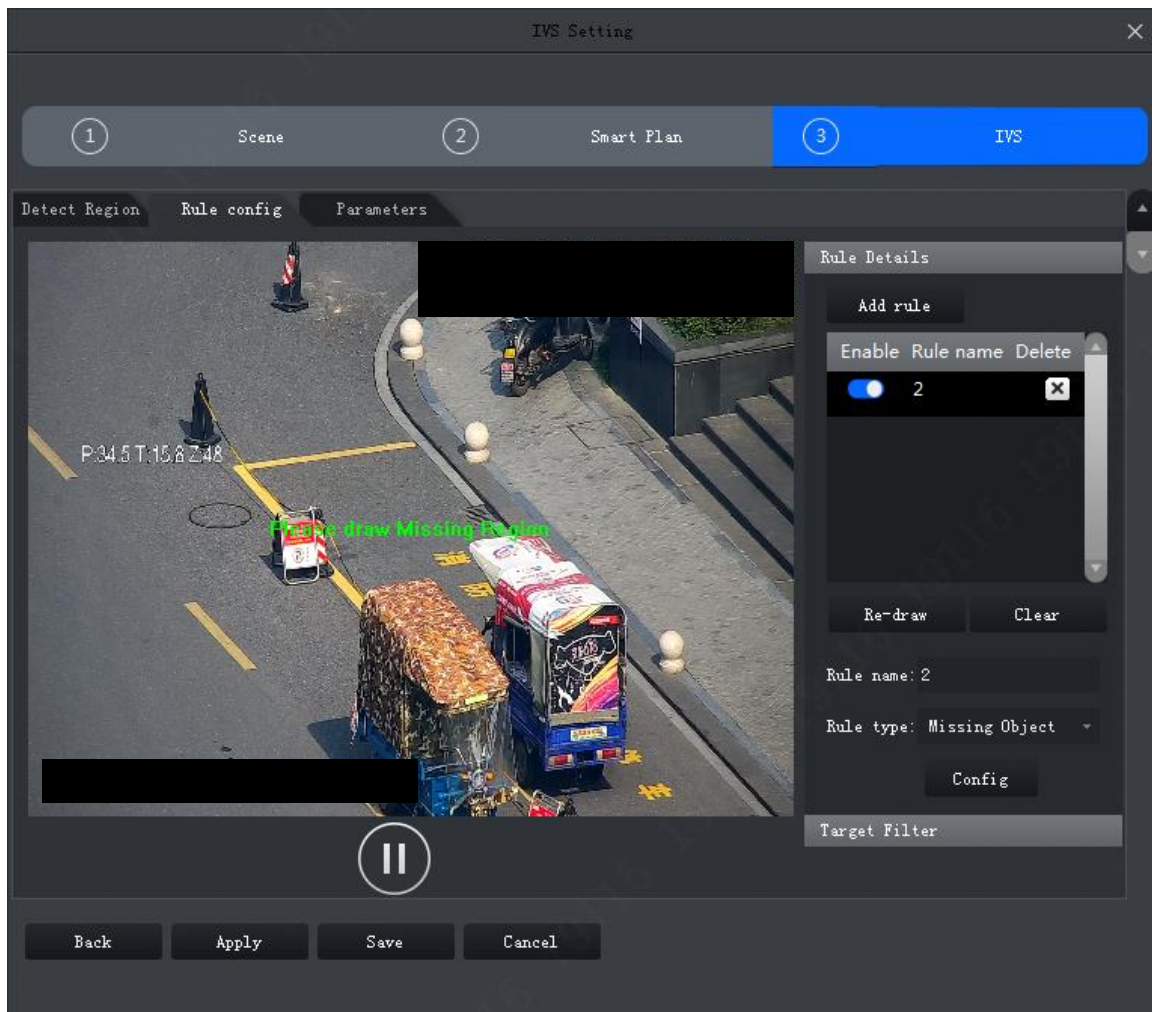



Figure 4-34

Step 1. Click Add rule.

Step 2. Enable rule and modify rule name and type.

1. Enable rule,  means to enable corresponding IVS rule.
2. Modify rule name.
3. In Rule type dropdown list, select Missing object.

Step 3. In monitoring video, draw detection zone, and right click to stop drawing.

Note:

Select existing detection zone, click Clear or Re-draw to draw again.

Step 4. Set parameter, arm time and alarm link. Draw target filter, see Ch 4.4.2.4.1.

See Figure 4-35.

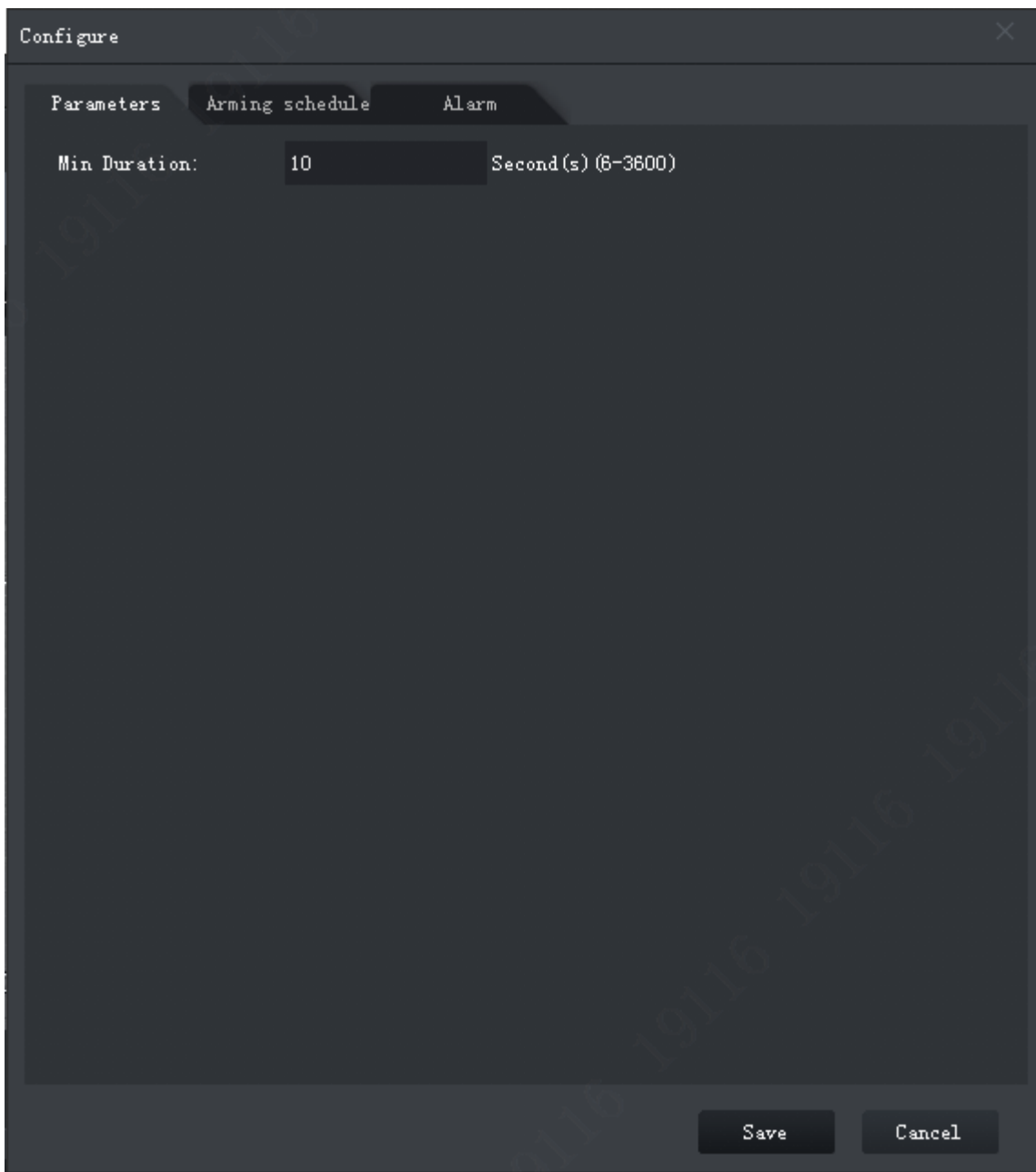

Figure 4-35

| Parameter | Note |
|--------------|---|
| Min Duration | Min time period between the object leaves detection zone and alarm trigger. |

Chart 4-10

Step 5. Click Apply.

4.4.2.4.9 Loitering Detection

When a target stays too long over set time length in detection zone, alarm is triggered.

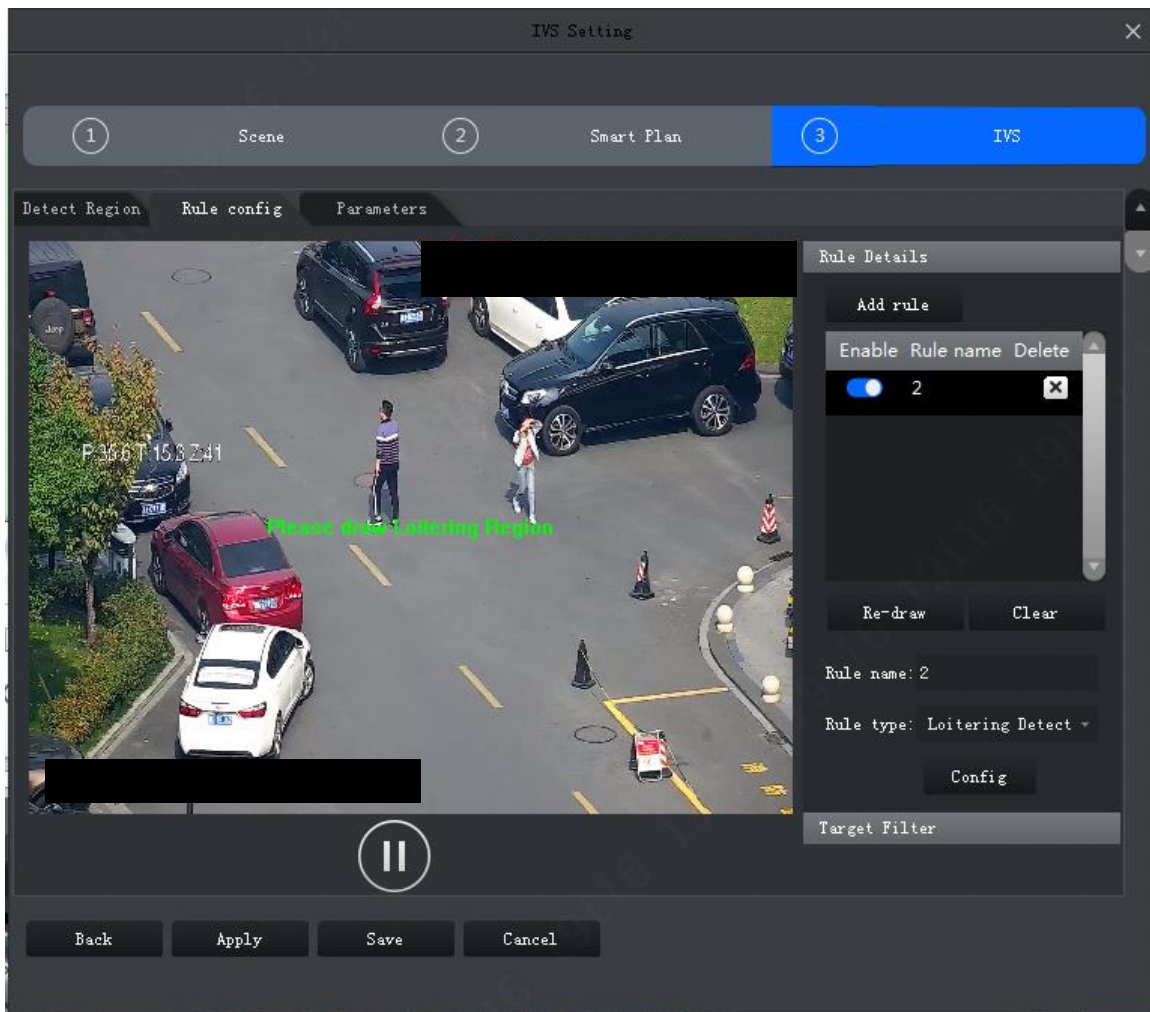



Figure 4-36

Step 1. Click Add rule.

Step 2. Enable rule and modify rule name and type.

1. Enable rule,  means to enable corresponding IVS rule.
2. Modify rule name.
3. In Rule type dropdown list, select Loitering detection.

Step 3. In monitoring video, draw detection zone, and right click to stop drawing.

Note:

Select existing detection zone, click Clear or Re-draw to draw again.

Step 4. Set parameter, arm time and alarm link. Draw target filter, see Ch 4.4.2.4.1.

See Figure 4-37.

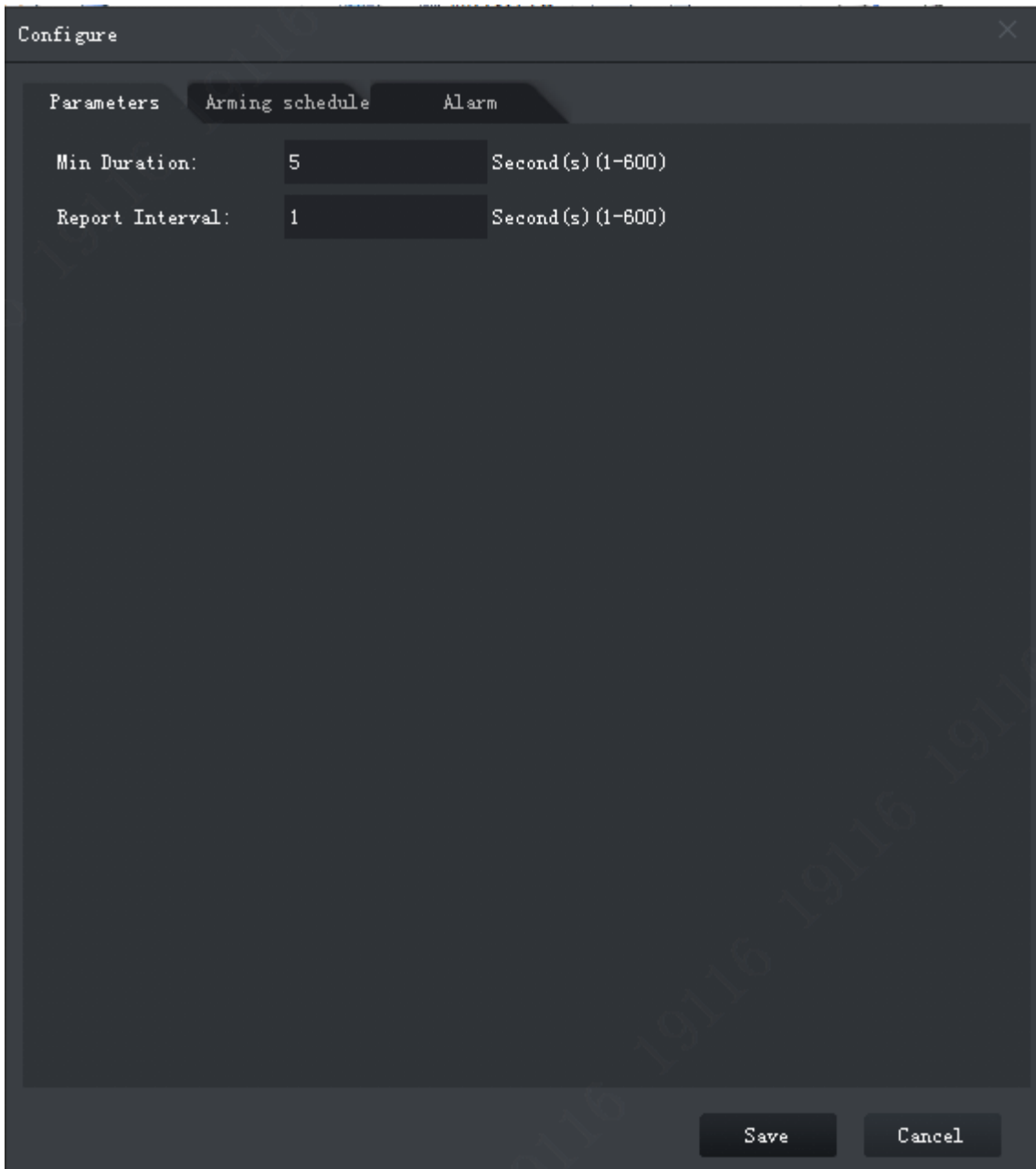

Figure 4-37

| Parameter | Note |
|-----------------|--|
| Min Duration | Min time period between the object loiters in detection zone and alarm trigger. |
| Report Interval | When alarm is triggered, if alarm event still exists, then user may set interval to alarm again and again. |

Chart 4-11

Step 5. Click Apply.

4.4.2.5 Parameters

Set global parameters for general behavior analysis, including whether to anti-jitter and add shadow in video and set sensitivity.

Step 1. In Rule config tab, complete IVS rule setup, click Parameters tab, see Figure 4-38.

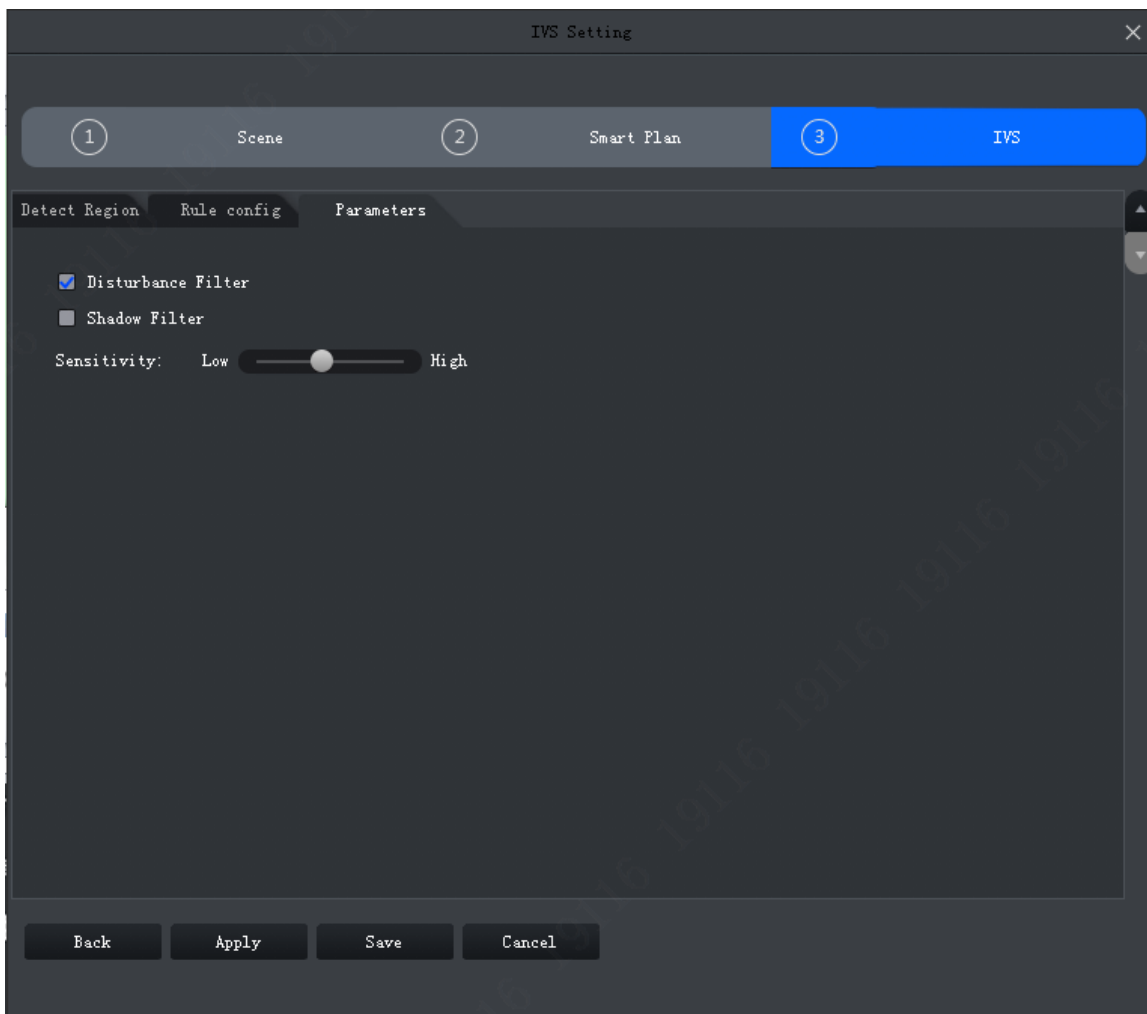

Figure 4-38

Step 2. Set parameter, see Chart 4-12.

| Parameter | Note |
|--------------------|--|
| Disturbance Filter | Filter disturbance of random swing (i.e. water wave and etc.), generally used in outdoor environment. This function may cause miss-detection. |
| Shadow Filter | Filter shadow, if not enabled, then system will auto detect target shadow. |
| Sensitivity | Sensitivity of control target. The lower the value, the less wrong detection will be, but missed detection will be more. Sensitivity is from low to high with scene from fewer to more. |

Chart 4-12

Step 3. Click Save.

4.5 Smart Track Config (Fisheye+Dome)

Smart track (fisheye+dome) sets fisheye camera as master camera with panorama view, and sets speed dome as slave camera.

4.5.1 Calibration Requirement

To improve calibration success rate and accuracy, please follow:

- Calibrate at least 3 groups, max 10 groups. 4 groups is recommend.

- Start from far to close by clockwise or counterclockwise direction. Point of calibration shall be even.
- Calibrate position with obvious traits, such as cross of object corner. See Figure 4-39 and Figure 4-40 Bad Calibration.



Figure 4-39 Good Calibration



Figure 4-40 Bad Calibration

4.5.2 Calibrate Camera

Step 1. On device tree select fisheye device, right click select Smart Track Config, see Figure 4-41.

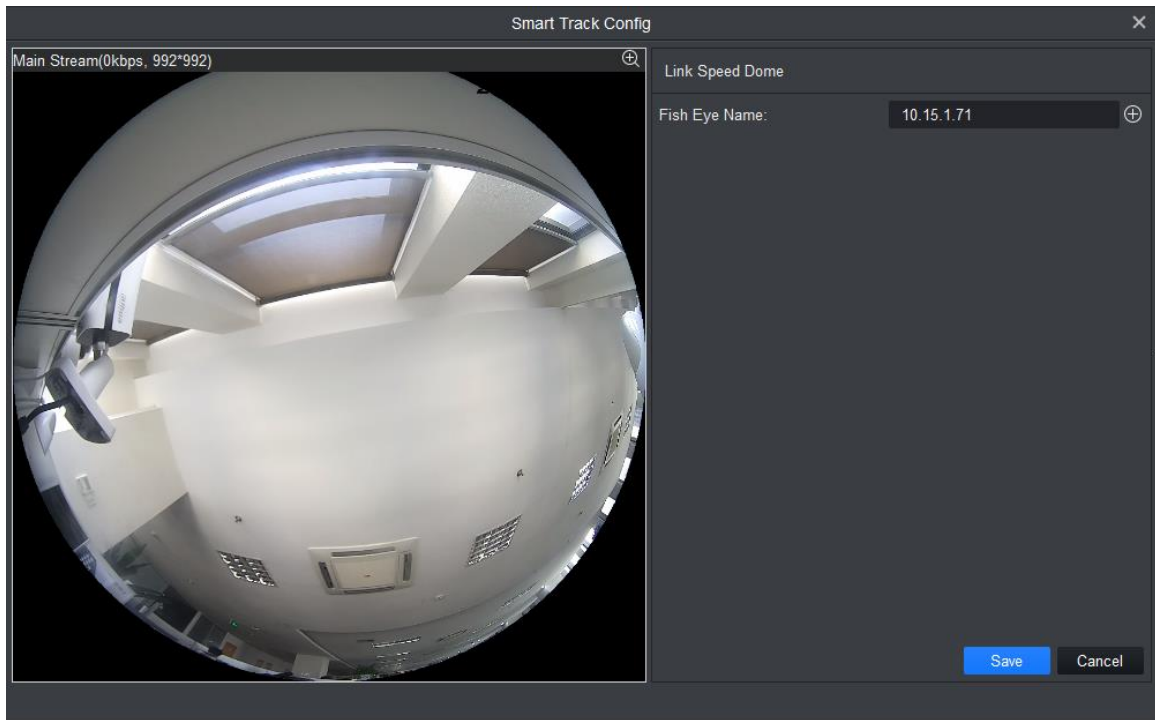

Figure 4-41

Step 2. Link speed dome. See Figure 4-42.

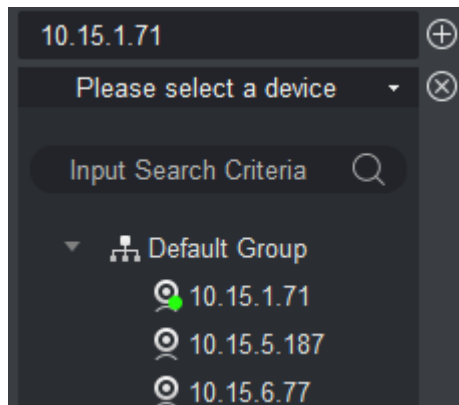

Figure 4-42

1. In Link Speed Dome area, click  next to fisheye name.
2. In speed dome dropdown list, select speed dome.
3. Click Save. See Figure 4-43.



Figure 4-43

Step 3. Add calibration point.

1. Click Add, you will see a cross sign and a new record generated.
2. Drag fisheye cross sign to appropriate position.

Note:

- To improve calibration accuracy, please use far object as reference for first group. Other calibrations points can be clockwise or counterclockwise distributed.
 - Calibrate position with obvious traits, such as cross of object corner.
3. In speed dome image, adjust speed dome position to make center of speed dome match the cross sign of fisheye. See Chart 4-13.

| Icon | Name | Note |
|------|----------------|---|
| | Zoom | Zoom in/out speed dome |
| | Focus | Adjust speed dome focus |
| | Iris | Adjust speed dome brightness |
| | E-mouse | Electronic mouse |
| | Quick Position | Click this icon, drag mouse in monitoring video, select area, then video automatically adjust by making pane as center. |

Chart 4-13

4. Click to save calibration info.
5. Repeat step 1~4 to complete remaining calibration position. N
6. Click OK.

4.5.3 Achieve Smart Track (Fisheye and Dome)

After you complete calibration, user may view link effect in smart track interface.

Step 1. On device tree, select fisheye device, right click Smart Track. See Figure 4-44.

- By default link mode is enabled, click  and user may switch between fisheye correction mode and link mode.
To enable fisheye correction, user may select installation method and view mode in fisheye preview window. Refer to Ch 4.8.
- On the left user may set PTZ, refer to Ch 4.7.

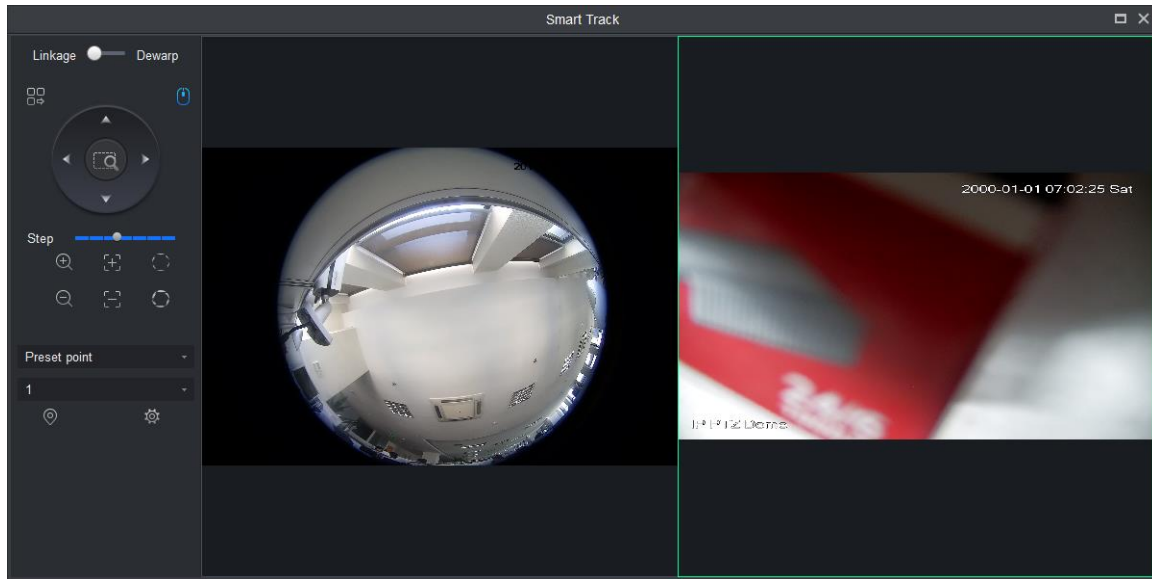

Figure 4-44

Step 2. Execute the following operation to see link effect.

- Link
Click any position in fisheye channel, speed dome will rotate to corresponding position and auto adjust zoom, see Figure 4-45.

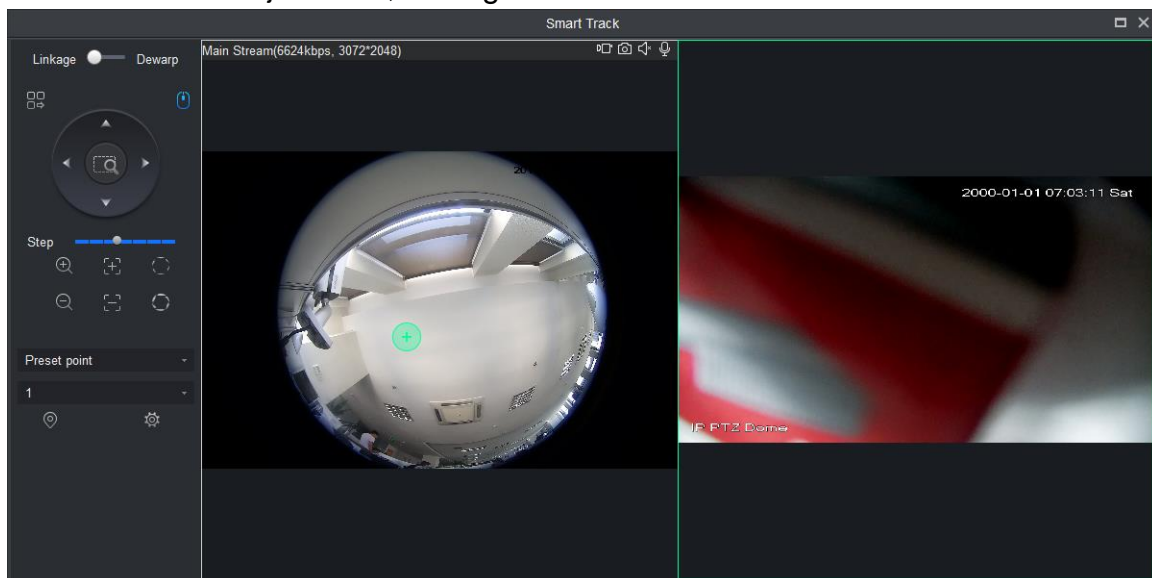

Figure 4-45

- **Pane link**

Select panel in fisheye video, speed dome rotates to corresponding area, see Figure 4-46.

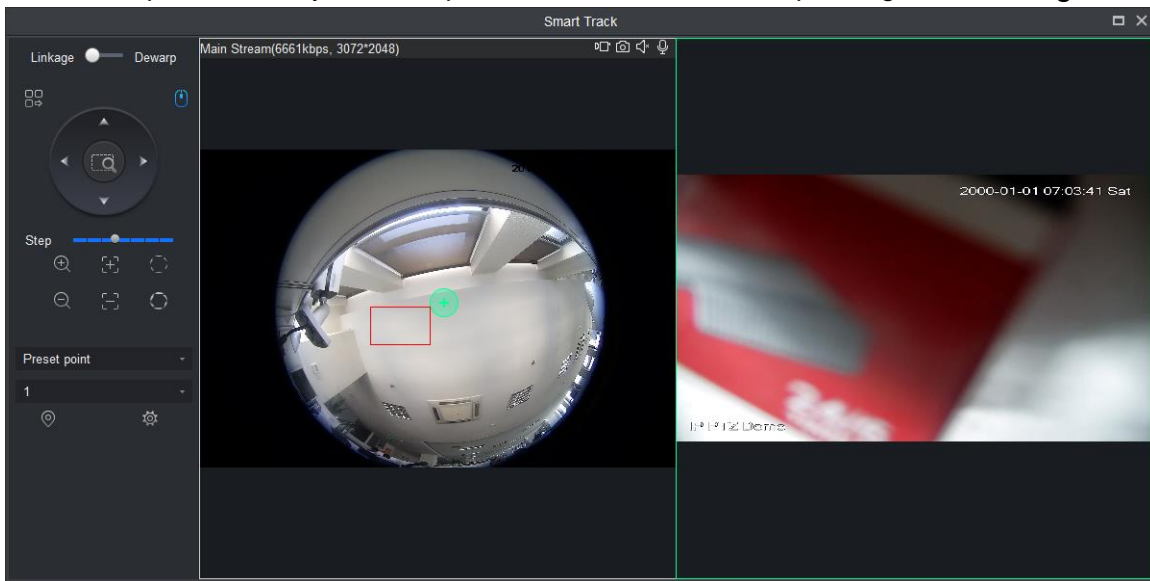

Figure 4-46

- **Drag link**

Drag position calibration in fisheye video, speed dome rotates with the calibration, see Figure 4-47.

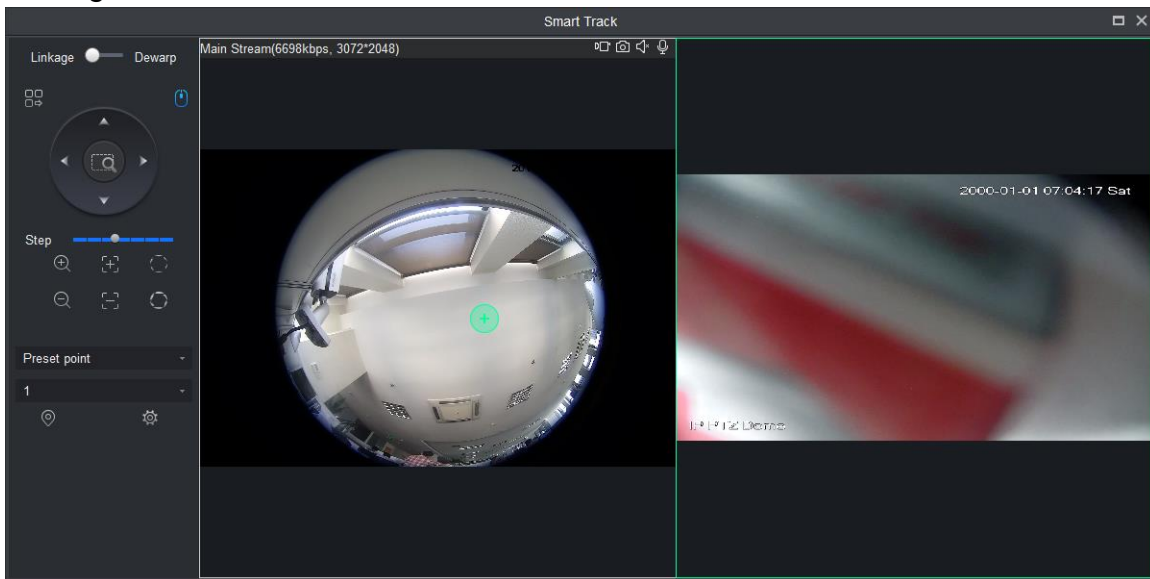

Figure 4-47

4.6 Smart Track Config (Dome+Fixed)

After you have configured dome and fixed camera linkage, when intelligent rule of fixed camera triggers alarm, speed dome auto links to corresponding position and tracks object until the object exceeds monitor range or tracking time limit.

4.6.1 Calibration Requirement

To improve calibration success rate and accuracy, please follow:

- Calibrate at least 4 groups, max 8 groups. 4 groups is recommend.

- Start from far to close by clockwise or counterclockwise direction. Point of calibration shall be even.
 - Calibrate position with obvious traits, such as cross of object corner.
- See Figure 4-48.



Figure 4-48 Good Calibration

4.6.2 Calibrate Camera

Step 1. Select fixed camera on device tree, right click Start Track Config, see Figure 4-49.

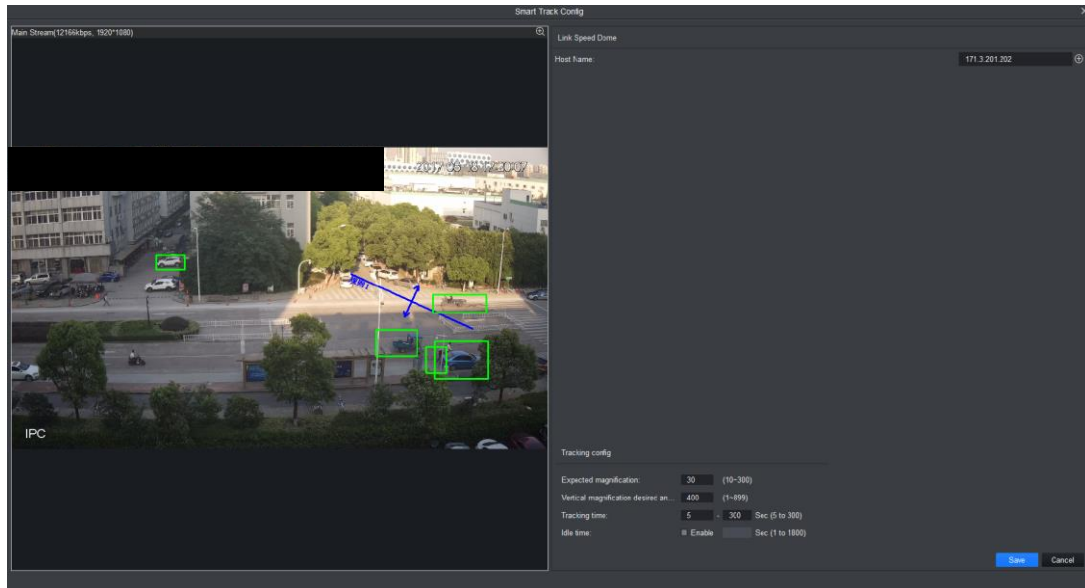

Figure 4-49

Step 2. Link speed dome, see Figure 4-50.

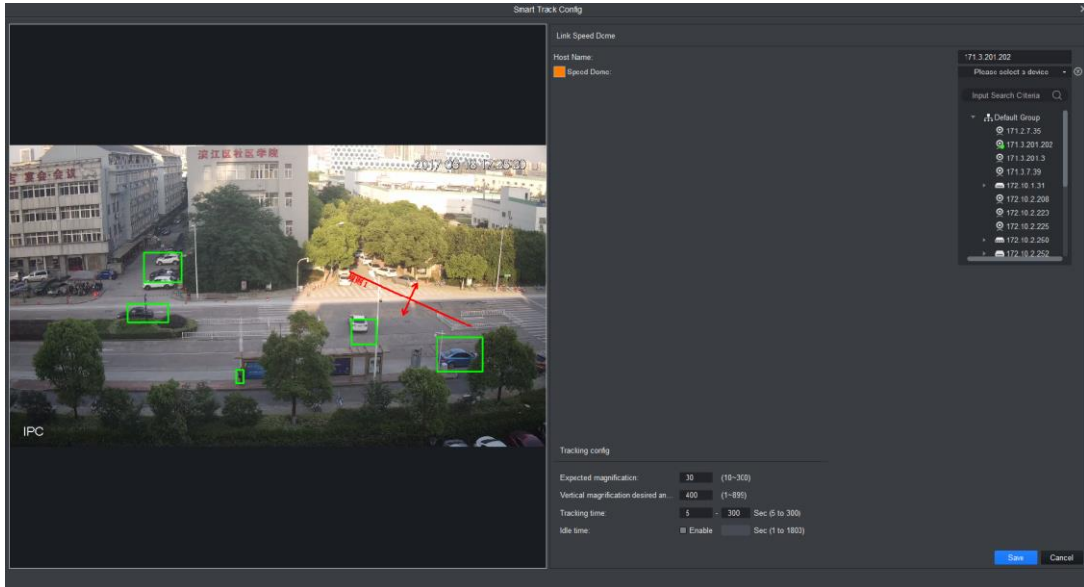



Figure 4-50

1. In link speed dome area, click .
2. Click  and in dropdown list select speed dome.
3. Set tracking, see

| Parameter | Note |
|--------------------------------------|---|
| Expected magnification | Link speed dome tracking magnification. |
| Vertical magnification desired angle | Link speed dome vertical magnification desired angle. |
| Tracking time | Support setup of upper limit and lower limit. If tracking reaches min limit, current tracking can be interrupted. If a new target appears, it will track new target. If tracking reaches max limit, tracking end. |
| Idle time | Select Enable, enable idle time and then when there is no target in fixed camera and reaches set time, speed dome returns to preset point. |

Chart 4-14

4. Click Save, see Figure 4-51.

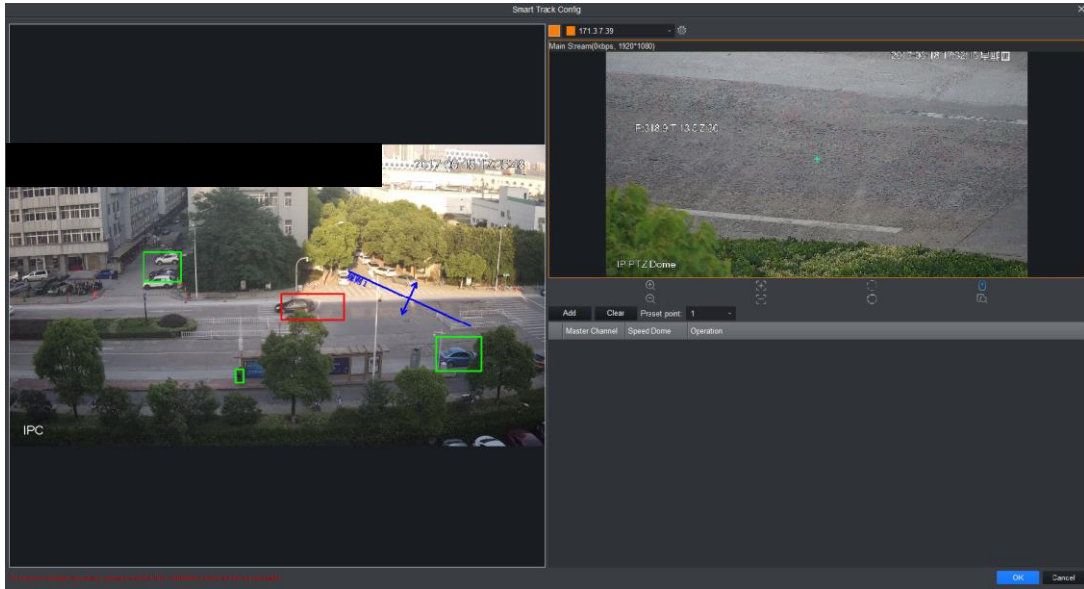

Figure 4-51

Step 3. Calibrate fixed and dome, see Figure 4-52.

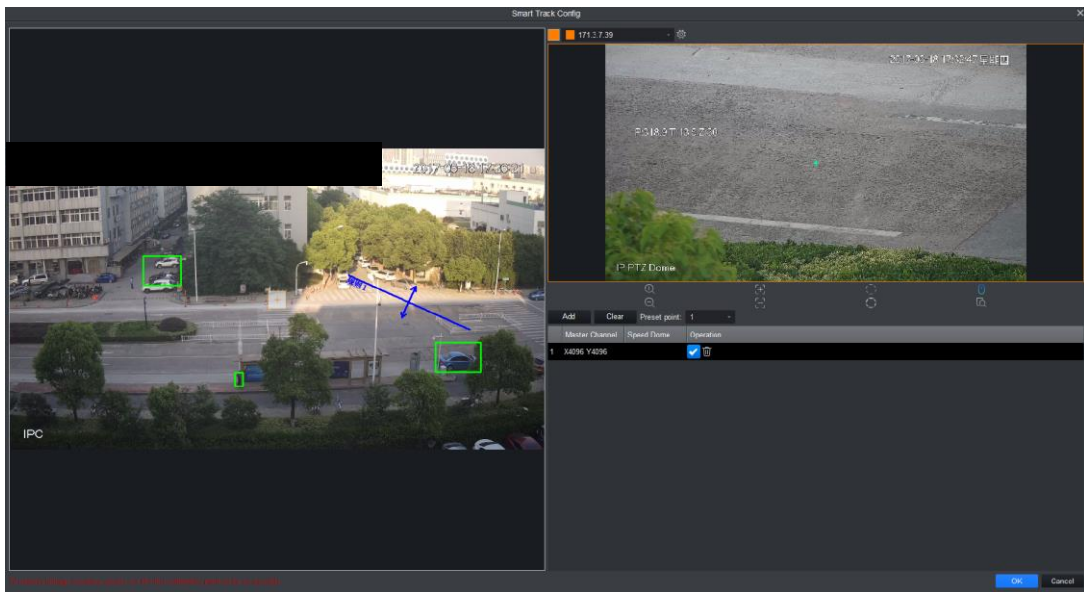

Figure 4-52

1. Click Add, a cross appears in video and meantime a record is generated.
2. Drag cross to appropriate position.

Note:

- Start from far to close by clockwise or counterclockwise direction. Point of calibration shall be even.
 - Calibrate position with obvious traits, such as cross of object corner.
3. In video of speed dome, adjust speed dome position via icon below to make center of speed dome match + in fixed camera video.

| Icon | Name | Note |
|------|------|------|
|------|------|------|

| Icon | Name | Note |
|------|----------------|---|
| | Zoom | Zoom in/out speed dome |
| | Focus | Adjust speed dome focus |
| | Iris | Adjust speed dome brightness |
| | E-mouse | Electronic mouse |
| | Quick Position | Click this icon, select any position to monitor, then user may adjust image with this position as center. |

Chart 4-15

4. Click  to save calibration info.

5. Repeat step 1~4, complete remaining calibration config.

Note:

Each speed dome calibrate at least 4 groups, max 8 groups. 4 groups is recommend.

6. Select preset return point.

When fixed camera video has no tracking to reach set length, speed dome can return to set preset.

7. Click OK, to save.

Successfully calibrated fixed camera, and system feedbacks. If failed, it will inform calibration failed and please try again.

4.6.3 Achieve Smart Track (Fixed and Dome)

After you complete calibration, user may view link effect in smart track interface.

Step 1. On device tree, select IPC device, right click Smart Track. See Figure 4-44.

On the left user may set PTZ, refer to Ch 4.7.

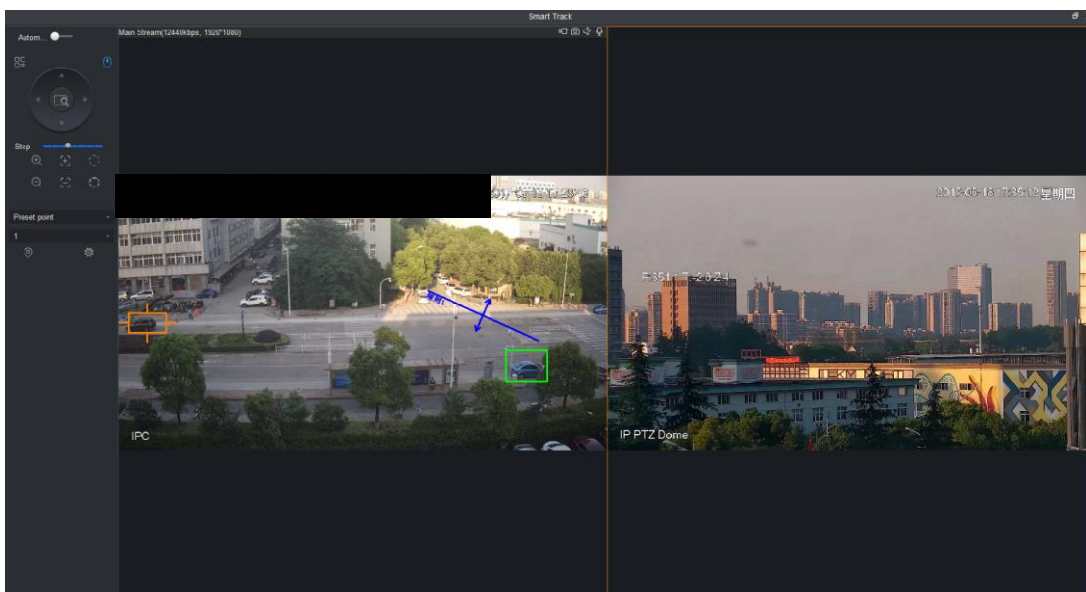

Figure 4-53

Step 2. Execute the following operation to see link effect.

- Manually position
Click any position in fixed camera video, link to speed dome. Speed dome will rotate to the corresponding position, see Figure 4-54.



Figure 4-54

- 3D Position
In fixed dome video pane select, speed dome will rotate to corresponding area and meantime zoom in/out.
Draw box from upper left to lower right, and zoom in when speed dome is fixed, see Figure 4-55.
Draw box from lower right left to upper left, and zoom in when speed dome is fixed, see Figure 4-56.



Before



After

Figure 4-55



Before



After

Figure 4-56

- Manually track

Refer to Ch 4.4.2.

If you add device as speed dome or PTZ device and support scene config and preset config.

Add Preset

Step 1. In Scene interface, click Add, see Figure 4-57.

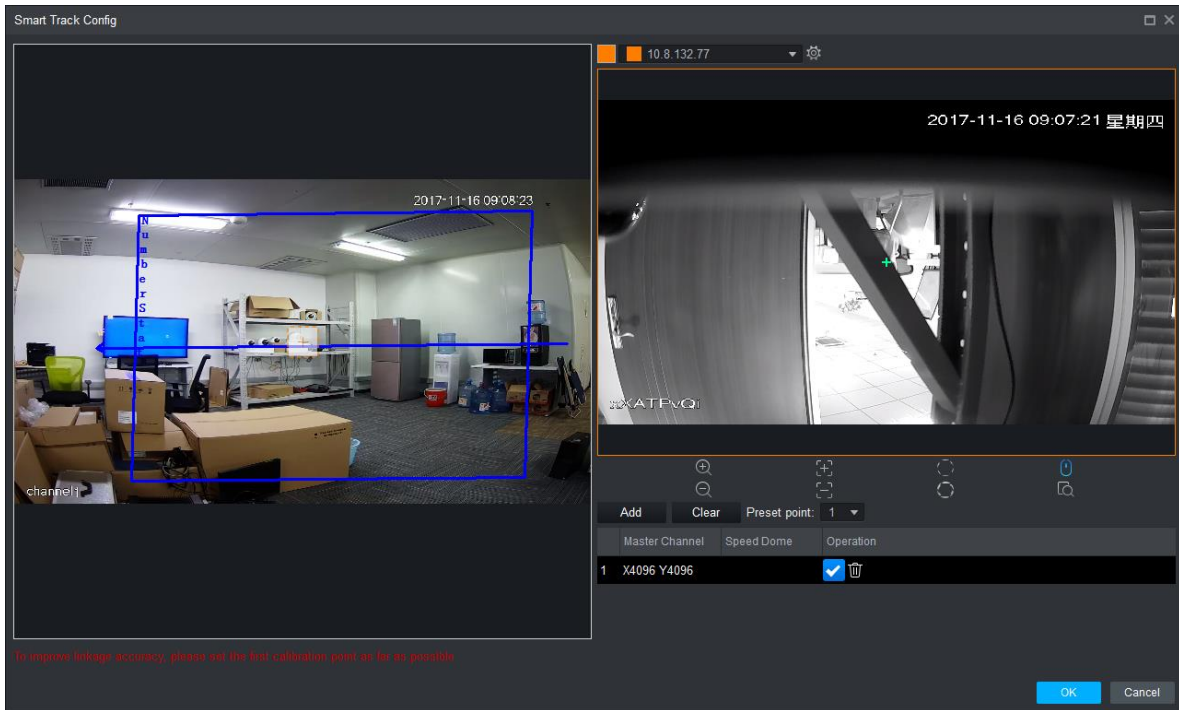

Figure 4-57

Step 2. Via PTZ direction control, rotate camera to designated position.

Note:

Step length can control PTZ speed, within 1~8 step length.

Step 3. Click OK.

Modify Preset

Step 1. In Scene interface, select preset to modify, see Figure 4-57.

Step 2. Via PTZ direction control, rotate camera to designated position.

Note:

Step length can control PTZ speed, within 1~8 step length.

Step 3. Click OK.

Delete Preset

Step 1. In Scene interface, select preset to delete, see Figure 4-57.

Step 2. Click Delete.

Note:

To ensure accuracy of manually tracking, please click  at the upper right corner to

disable tracking. Icon become .

In fixed dome video monitoring, click moving target box (inside box is OK), target box changes color, and speed dome select target.



Before



After

Figure 4-58

4.7 PTZ

PTZ of different devices have different setup interfaces, subject to actual condition. See the following figures and charts.

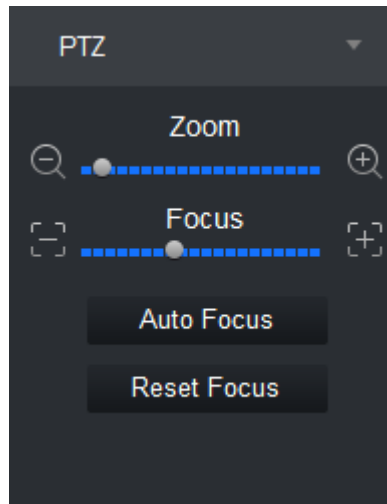

Figure 4-59

| Parameter | Note |
|---------------|---|
| Zoom | Click or to adjust zoom. |
| Switch to PTZ | Click Switch to PTZ, system jumps to PTZ control. |
| Focus | Click or to adjust definition. |
| Auto Focus | Click Auto Focus to auto focus. |

| | |
|-------------|-----------------------------|
| Reset Focus | Click Reset Focus to reset. |
|-------------|-----------------------------|

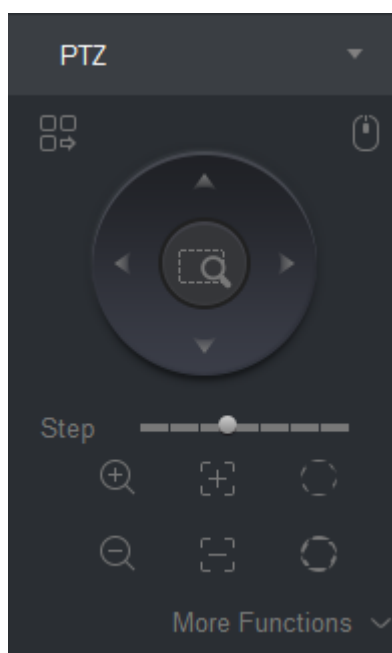













Figure 4-60

| Parameter | Note |
|-------------------|--|
| Menu | Click  go to PTZ menu. |
| Mouse stimulation | Click  , via mouse operate PTZ. |
| Direction | Set PTZ direction in 4 directions. |
| 3D position | Click  , and draw a box in video monitoring, PTZ will rotate and focus to this scene. |
| Step | Control PTZ rotation speed, can be set 1 to 8 different rotation step. |
| Zoom | Click  or  to adjust zoom. |
| Focus | Click  or  to adjust definition. |
| Iris | Click  or  to adjust brightness. |
| Preset | By setting the Preset, user may quickly go to the preset position corresponding to the camera. Preset setting For details, see Ch 4.7.1. Note: User may set up to 128 presets. |

| Parameter | Note |
|---------------------|---|
| Tour | By setting Cruise, the camera can cruise between different preset points. Cruise setting details, see Ch 4.7.2. Note: User may set up to eight cruise group. |
| Horizontal rotation | By setting Horizontal rotation, the camera can be rotated horizontally. in  , Select Horizontal rotation and click  , turn on horizontal rotation. |
| Scan | By setting the two borders, the camera rotates repeatedly between the two borders. Scan settings For details, see Ch 4.7.3. |
| Pattern | By setting the Tour track, the user operation during the rotation of the camera recorded, the camera can be rotated according to the track record. Patrol track setting details, see Ch 4.7.4. |
| AUX | With aux, aux commands can be entered to turn on the aux points. |
| Windshield wiper | Click  to control wiper. |

4.7.1 Preset

By setting the preset point, user may quickly go to the preset position corresponding to the camera.

Step 1. Via PTZ direction control the camera to designated position.

Step 2. In  select preset, click .

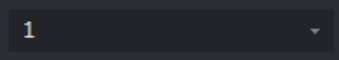
Step 3. In  select preset no., enter preset name.

Step 4. Click  to save preset.

Step 5. Click  to delete non-necessary preset.



Step 6. Select preset and click , camera rotates to corresponding position.

4.7.2 Tour

By setting the tour, the camera can tour between the different preset points.

Warning:

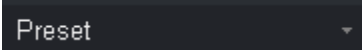
Set at least two presets before user may tour.

Step 1. In , select tour, and click . See Figure 4-61.

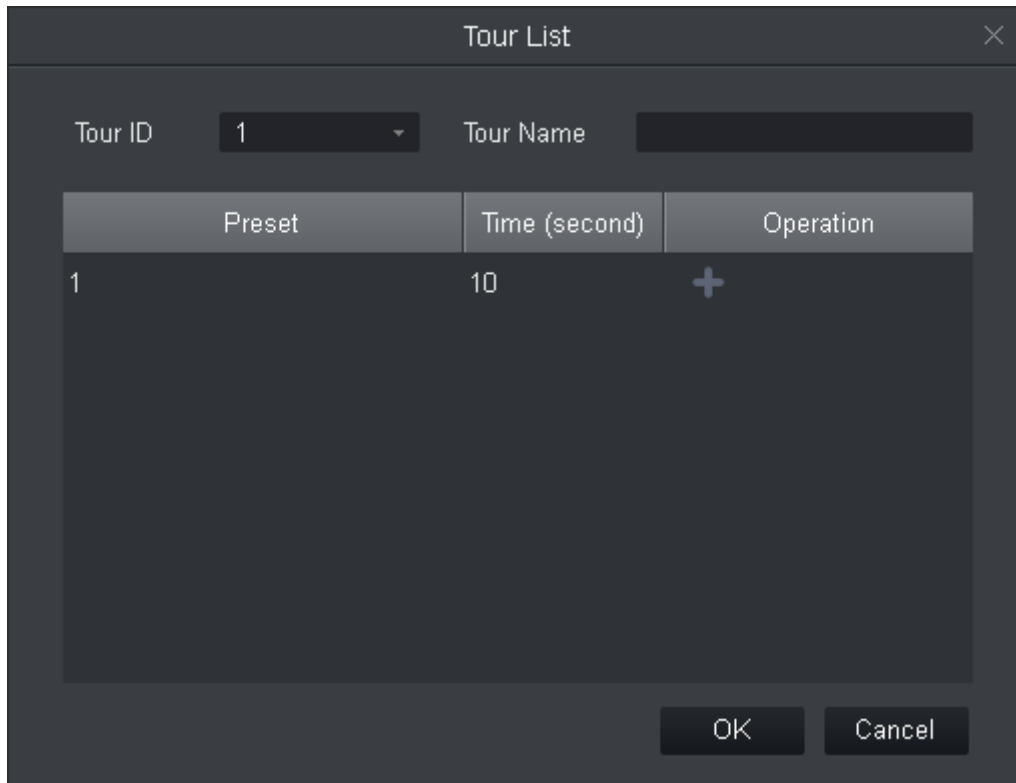



Figure 4-61

Step 2. Set tour no. and tour name.

Step 3. Select preset.

- a) In Preset list select preset, and enter time.
- b) Click  to add preset.

Repeat this step to add more presets.

Step 4. Click OK.

Step 5. You need to select tour no., click  so camera will tour among different presets.

4.7.3 Scan

By setting the two borders, the camera rotates repeatedly between the two borders.

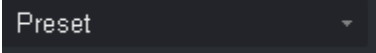
Step 1. In  select Scan.

Step 2. By control PTZ direction, rotate PTZ to designated left position, click  to set left border.

Step 3. By control PTZ direction, rotate PTZ to designated right position, click  to set right border.

Step 4. Click  to repeat rotation among two borders.

4.7.4 Pattern

Record down camera rotation process, via pattern rotation function.

Step 1. In  select Pattern.

Step 2. Click  to start to set pattern, and zoom, focus or rotate camera.

Step 3. Click  to complete.

Step 4. Select pattern no., click , camera rotate pattern according to record.

4.7.5 Enable Windshield Wiper



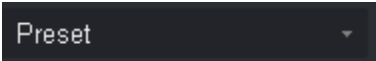

When speed dome has windshield wiper, SmartPSS can control windshield wiper.







Step 1. In  select wiper.

Step 2. Click  to wipe speed dome once.

4.8 Fisheye View Mode

Only fisheye device supports installation and view mode, different installation modes corresponding to view mode referring to the following chart.

| parameter | Description | |
|------------------------|--|--|
| View mode | Current video screen (by default support the original image mode), in accordance with the different installation methods, with other different presentation as follows: <ul style="list-style-type: none"> • Ceiling: 1P + 1, 2P, 1 +2, 1 +3, 1 +4, 1P +6, 1 +8. • Wall mount: 1P, 1P + 3, 1P + 4, 1P + 8. • GND: 1P +1,2 P, 1 +3, 1 +4, 1P +6, 1 +8. Note: When switching installation mode, by default show the original image mode. | |
| Ceiling/wall mount/GND |  original image | That is the original image has not been corrected. |
| Ceiling |  1 + 2 | That is the original video +2 independent sub videos and the sub-frame in sub video and original image support zoom, move. |
| Ceiling/ wall mount |  1P + 1 | As 360 ° rectangle panoramic + independent sub video, and sub-frame in sub video and original rectangle panoramic support zoom, move. Rectangle panoramic also supports move of left/right starting point. |
| |  2P | As two linked 180° rectangle video, at any moment the two windows form a 360° panorama, as “dual panorama”. Two rectangle video both support move of left/right starting point and link each other. |
| |  1 + 3 | As original image +3 independent sub videos and the sub-frame in sub video and original image support zoom, move. |

| | | |
|------------|---|--|
| |  1 + 4 | As original image +4 independent sub videos and the sub-frame in sub video and original image support zoom, move. Original video also support move of left/right starting point. |
| |  1P + 6 | As 360 ° rectangle panoramic +6 independent sub videos, and sub-frame in sub video and original rectangle panoramic support zoom, move. Rectangle panoramic also supports move of left/right starting point. |
| |  1 + 8 | As original image +8 independent sub videos and the sub-frame in sub video and original image support zoom, move. |
| Wall mount |  1P | As 360° rectangle panorama from left to right, 180° rectangle panorama support up/down move to change to vertical view. |
| |  1P + 3 | As 360° rectangle panorama +3 independent sub video, and the sub-frame in sub video and original image support zoom, move. Rectangle panorama support up/down move to change to vertical view. |
| |  1P + 4 | As 360° rectangle panorama +4 independent sub video, and the sub-frame in sub video and original image support zoom, move. Rectangle panorama support up/down move to change to vertical view. |
| |  1P + 8 | As 360° rectangle panorama +8 independent sub video, and the sub-frame in sub video and original image support zoom, move. Rectangle panorama support up/down move to change to vertical view. |

4.9 Device Preview via DNA6336 Keyboard

Via DNA6336 keyboard, user may enable device preview, split preview window, control PTZ, close preview video and etc.

Condition

- Set and record device no. of device to be operated.
- Keyboard connected PC where SmartPSS is installed.
- Logged in SmartPSS interface and open preview.

Step

Step 1. Connect keyboard, power indicator is ON. After it is running, LCD shows welcome interface. Click OK or Set key.

Step 2. Via rocker, enter username and password, click OK. It shows homepage.

Note:

Admin user has default password as 888888.

Step 3. Via rocker, left/right select mode to be preview, and click OK.

Step 4. Operate preview interface, see Chart 4-16.

| Function | Note |
|----------------|---|
| Split Window | Click 【window number】 , and then click 【split】 to split windows. Window number of number of split. |
| Enable Preview | By sequence of 【window no.】 and 【ID】 key, select |

| | |
|---------------|---|
| | <p>preview window and then click 【device no.】 and 【channel】 key to enable corresponding preview video of device.</p> <p>Window no. is 1 at upper left corner, starting from left to right, up to down.</p> |
| Close Preview | <p>Click 【window no.】 and 【ID】 key respectively. Select window in preview, and click 【0】 and 【channel】 key. Close corresponding preview video.</p> <p>Window no. is 1 at upper left corner, starting from left to right, up to down.</p> |
| PTZ Control | <p>Enable speed dome video preview and keyboard in being operated. User may control speed dome direction, adjust it is, focus, zoom and etc.</p> <ul style="list-style-type: none"> ● Via rocker, rotate in up, down, left, right, up left, up right, down left and down right directions. ● Click 【iris】 + or -, adjust iris. ● Click 【zoom】 + or -, adjust video definition. ● Click 【zoom】 + or -, adjust zoom. |

Chart 4-16

5. Tour & Task

5.1 Config Task Plan

By setting tour plan, user may tour each window.

Step 1. Click , and click Tour & Task.

Step 2. Add tour plan.

1. Click Add. See Figure 5-1.

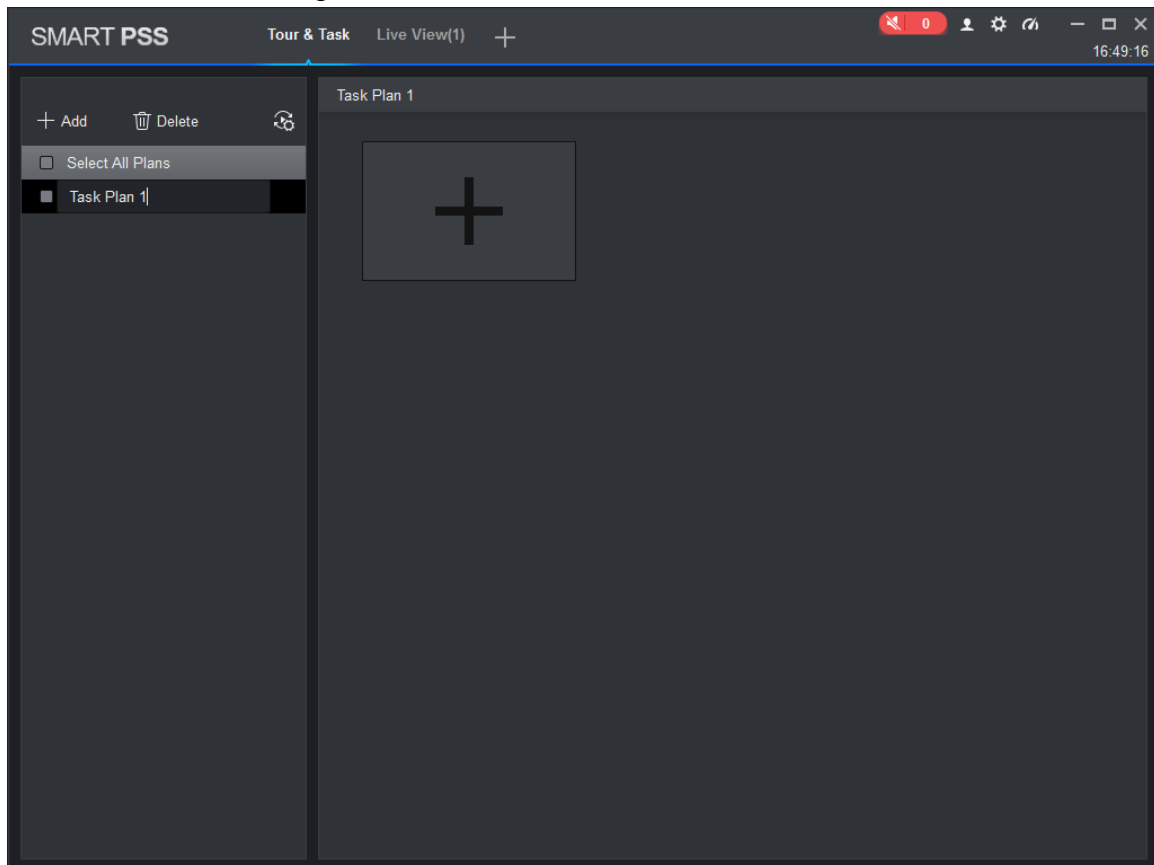



Figure 5-1

2. Modify task plan name.
When you add new task, user may edit task name immediately. Or user may double click tour plan name or click  to modify tour plan name.

Step 3. Set task. It supports to set multiple task. Here takes one task as example.

1. Click . See Figure 5-2.

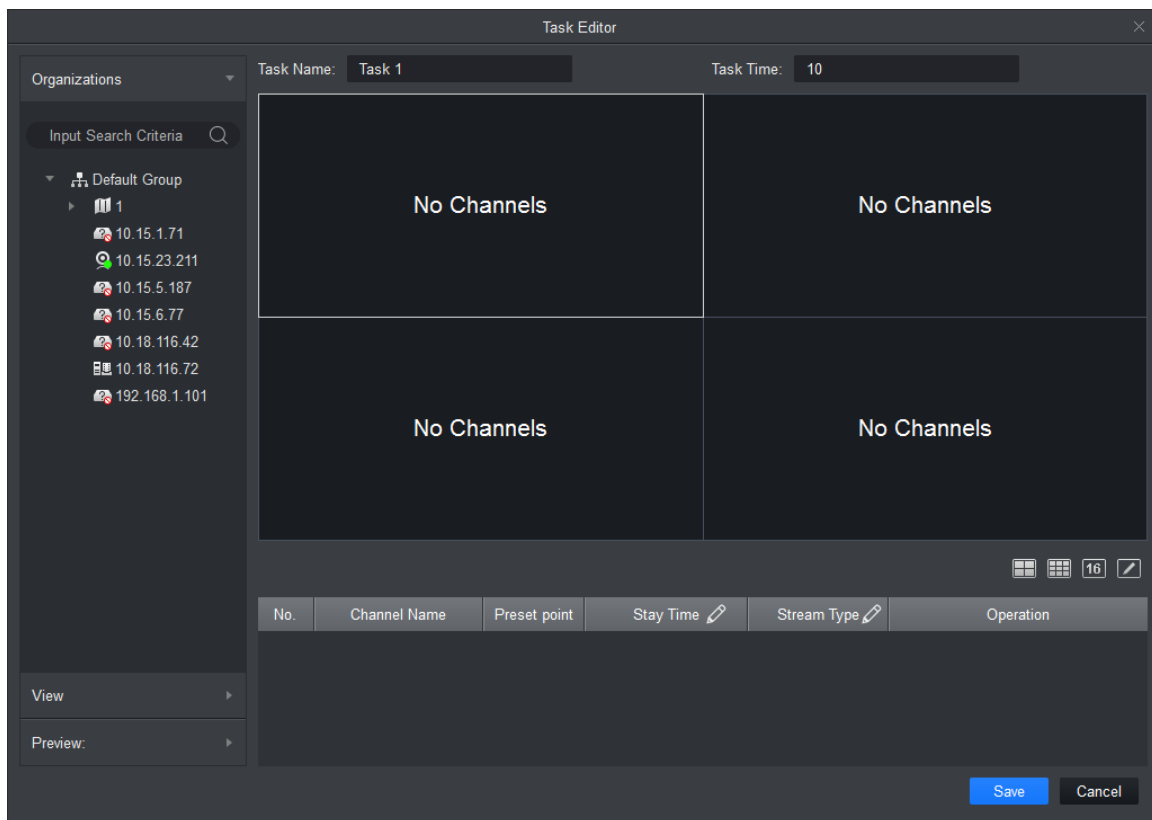



Figure 5-2

2. Set task name and time span, according to actual condition click  to set four window number.
3. Double-click the channel of the device or drag the channel of the device into the video window in the order that you want. See Figure 5-3.

Note:

- In the Organization Tree, right-click a storage device, select the Bind all channels, the storage channel in turn is bound to the corresponding video window ; select the video window to be bound in the Organization Tree, right-click a storage device, select the tie given zero channels zero bound channel to the selected video window.
- Select the video window to be bound, under the Organization Tree, right-click the channel storage devices, select the Bind channel, the channel will be bound to the selected video window.
- Select Bind video window, right-click the organizational tree in the front-end device, selects the Bind IPC, the front-end device bind to the selected video window.
- After the video channel bonding, right-click the video window, remove binds or remove all binds.

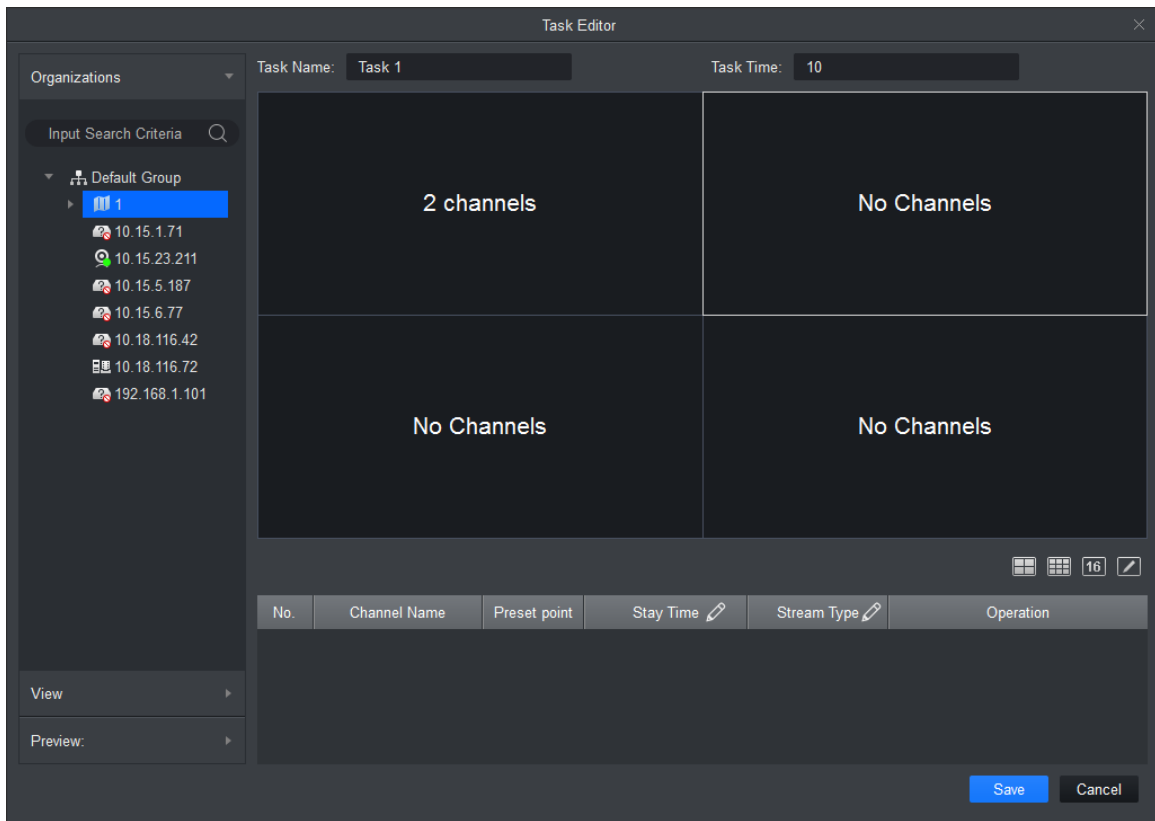





Figure 5-3

4. Set channel preset, time span, stream type and channel sequence.

Note:

- Click  of the corresponding channel, in the left preview screen to display live preview or e-map information.
- Click  or  of the corresponding channel, adjust the channel sequence in the task.
- Click  of the corresponding channel, delete the corresponding channel.

5. Click Save, See Figure 5-4.

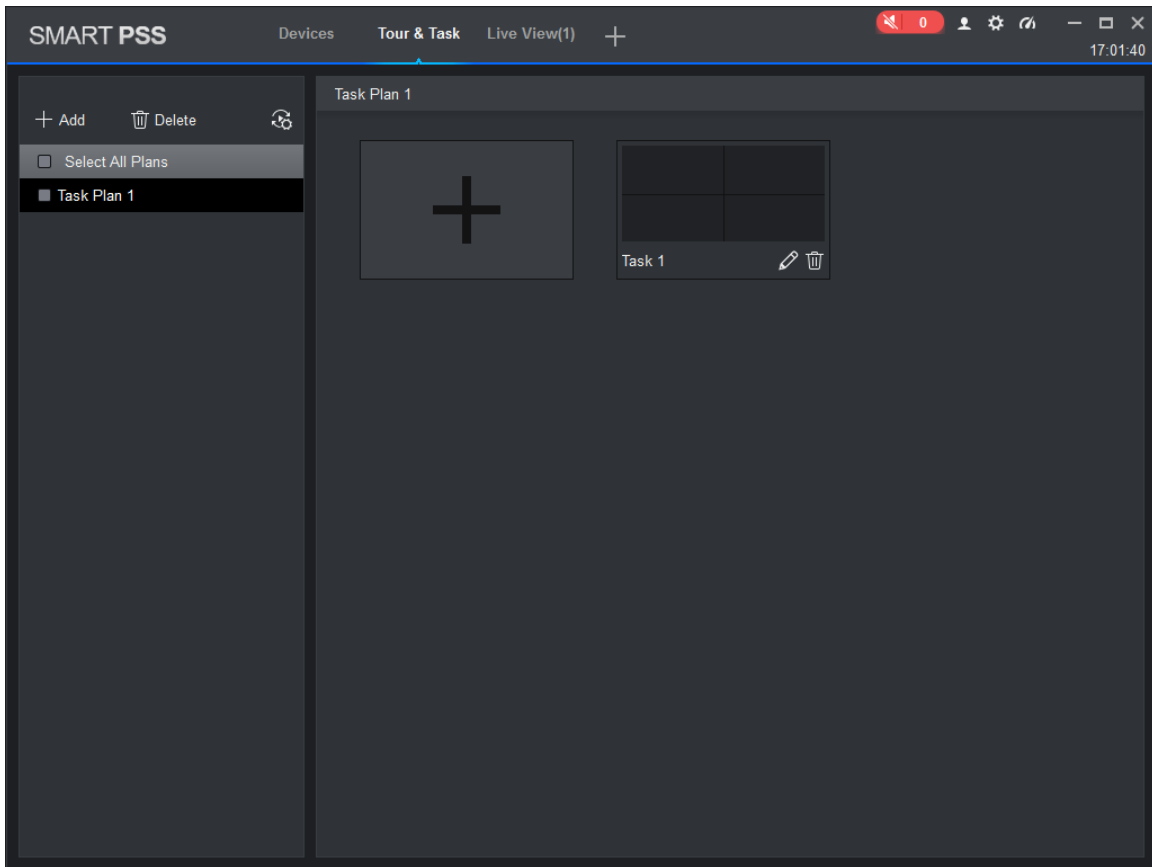



Figure 5-4

Step 4. Set tour task.

When you set multiple tasks, it support task plan by day or week.

1. Click  to run the plan. See Figure 5-5.

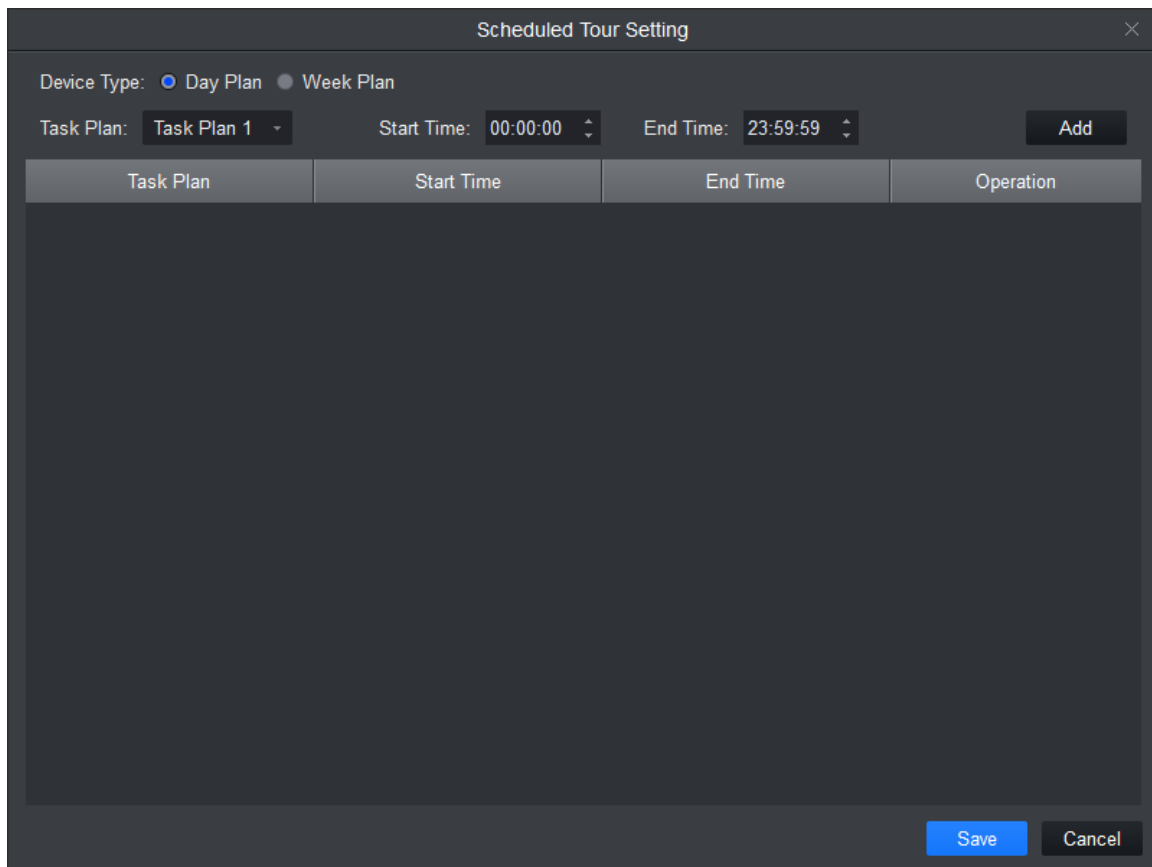

Figure 5-5

2. Select device type.
 - Day plan, period is day. There are many different periods in a day.
 - Week plan. There are 7 periods in a week.
3. Select tour plan, set time, click Add.
4. Set different period task, click Save.

5.2 Enable Task

If your device sets schedule, then within set time system will auto plays video according to task. If you want to manually tour, priority of manual task must be over scheduled task.

Step 1. In New function tab, click Live View.

Step 2. In the interface, select tour plan.

Step 3. Click  to enable task plan.

6. Playback

6.1 Playback

User may playback and export device record, device picture, local record and local picture.

In New tab, click  select Playback, see Figure 6-1.

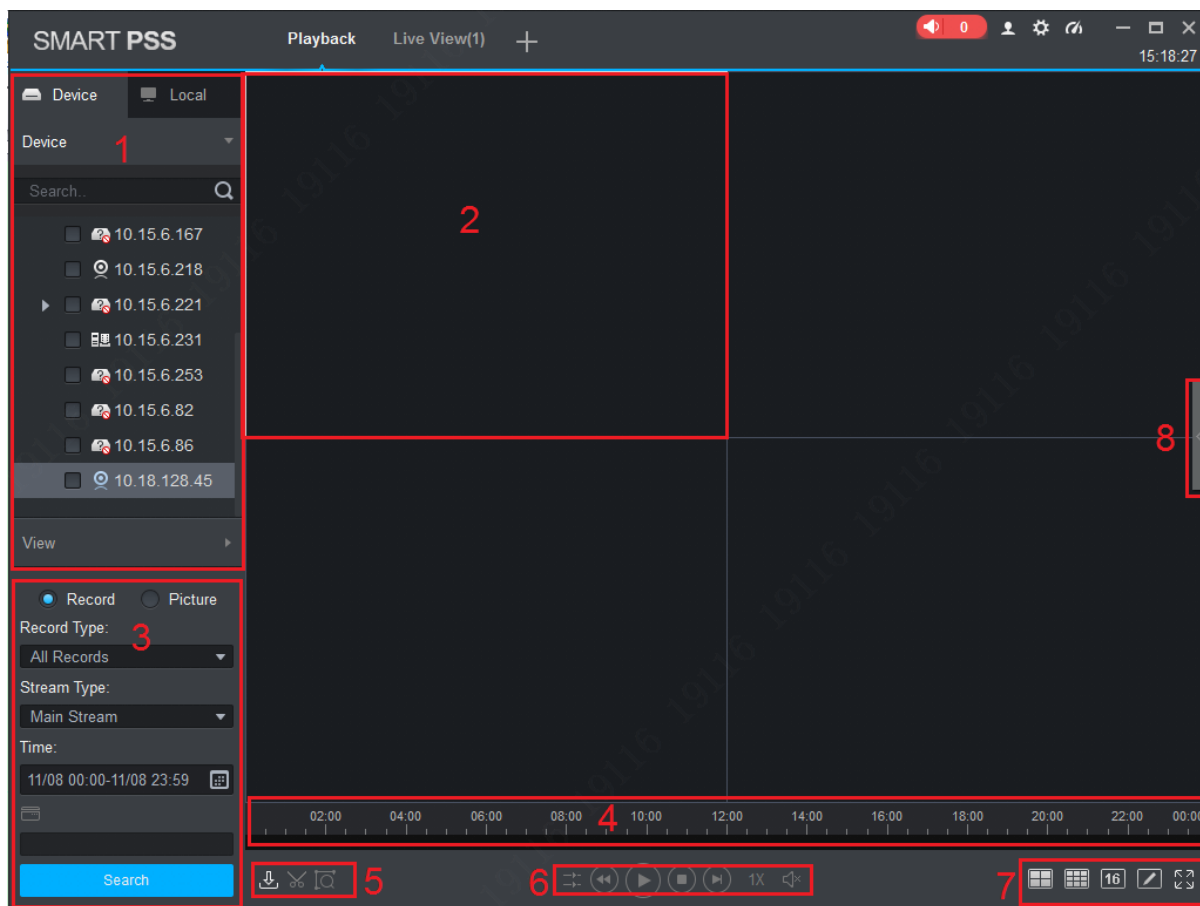























Figure 6-1

| No. | Task | Note |
|-----|-------------------------------|--|
| 1 | Playback video | User may play back the recording device. For details, see Ch 6.2. |
| | Playback image | User may picture playback device. For details, see Ch 6.4. |
| | Playback local video | User may play back the local video. For details, see For details, see Ch 6.6. |
| | Playback local picture | User may play back the local picture. For details, see For details, see Ch 6.8. |
| | Organization Tree / Area Tree | <ul style="list-style-type: none"> When the Default Device Tree is set to Device Tree (by device), the device tree displays the grouping and channels for the device. When a default device tree is set to Area Tree (by channel), |

| | | |
|---|---------------------------------------|---|
| | | <p>the device tree display channel.</p> <p>Default Device Tree setting, see Ch 8.</p> |
| | Logout and login | When the Default Device Tree is set to Device Tree (by device), right-click the device and select Logout. The software and device are disconnected. After logging out, right-click the device, select Login, reconnect device. |
| | View | In the Device tab, click  behind View . Open View interface, playback view video device. |
| 2 | View playback stream information | Choose video window with open video, in status bar it displays the playback stream information. |
| | Snapshot | <p>Select open video window, click  or right-click to select Snapshot, Snapshot a single picture.</p> <p>User may click  in the homepage, modify the path to save the picture.</p> |
| | Zoom | Select open playback video window, click  . |
| | Close window | Select Open playback video window, click  or right click to select Close Window . |
| | Close all windows | Select the video window, right-click to select Close all windows . |
| | IVS Overlay | Overlay IVS info, include rule and object box. |
| 3 | Set aspect ratio | Select the video window, right-select Window Scale, select the video aspect ratio. |
| | Enable Audio | <p>User may turn on the audio through the following two ways.</p> <ul style="list-style-type: none"> ● Select open playback video window, right-select Audio. ● Playback control toolbar at the click , and adjust the volume. |
| 4 | Set the device record search criteria | <p>In the Devices tab, select the device or view, select Record, set the record type, stream, start time and end time, click Search, the recording information is displayed in the schedule box.</p> <ul style="list-style-type: none"> ● Record type includes all types of video record, general record, alarm record, motion detection record, intelligent record and card record. ● Stream includes main stream and sub stream. ● Interval of start time and end time must be within a day. |
| | Set the device picture search | <p>In the Devices tab, select the device, or view, select Picture, set the start time and end time, click Search, image information is displayed in the playback window.</p> <p>Interval of start time and end time must be within a day.</p> |

| | | |
|---|-----------------------------------|---|
| | criteria | |
| 5 | Time progress bar | Show existing video display information. |
| 6 | View progress bar | Click  to view the video or image export progress and export results. |
| | Export record | Export device video files, see Ch 6.3. |
| | Export picture | Export device picture files, see Ch 6.5. |
| | Export local record | Export local video files. See Ch 6.7. |
| | Open Video | In the Local> |
| | Smart search | Select open playback video window, click  , in the video playback window, select the smart search, click device  again. The software will search for the video motion detection, click  to exit the smart search. |
| 7 | Playback control toolbar | <p>Control video playback and audio.</p> <ul style="list-style-type: none"> ●  Video playback from the same point in time for all channels. ●  Reverse video playback. ●  Start video playback. ●  Pause video playback. ●  Stop video playback. ●  Single frame backward playback. ●  Single-frame forward playback. ●  Adjust the playback speed. |
| 8 | Set the video window display mode | <ul style="list-style-type: none"> ● In  select the desired video window display mode or select  to customize video window display mode. ● Click  or select the video window, right select full screen, video window full screen display. |
| 9 | Video file list | Click the icon to expand the list of the corresponding channel video file, user may select video files for playback and export |

| | | |
|--|--|-------------------------------|
| | | the corresponding video file. |
|--|--|-------------------------------|

6.2 Playback Device Record

Condition

There is device record inside channel.

Steps:

Step 1. In playback interface, click Device tab.

Step 2. In Organization Tree, select device channel or select view in View.

Step 3. Select record and set record search criteria.

- a) Select record type and stream, and set time.
- b) Click Search.

Step 4. Select window with record, click .

See Figure 6-2.

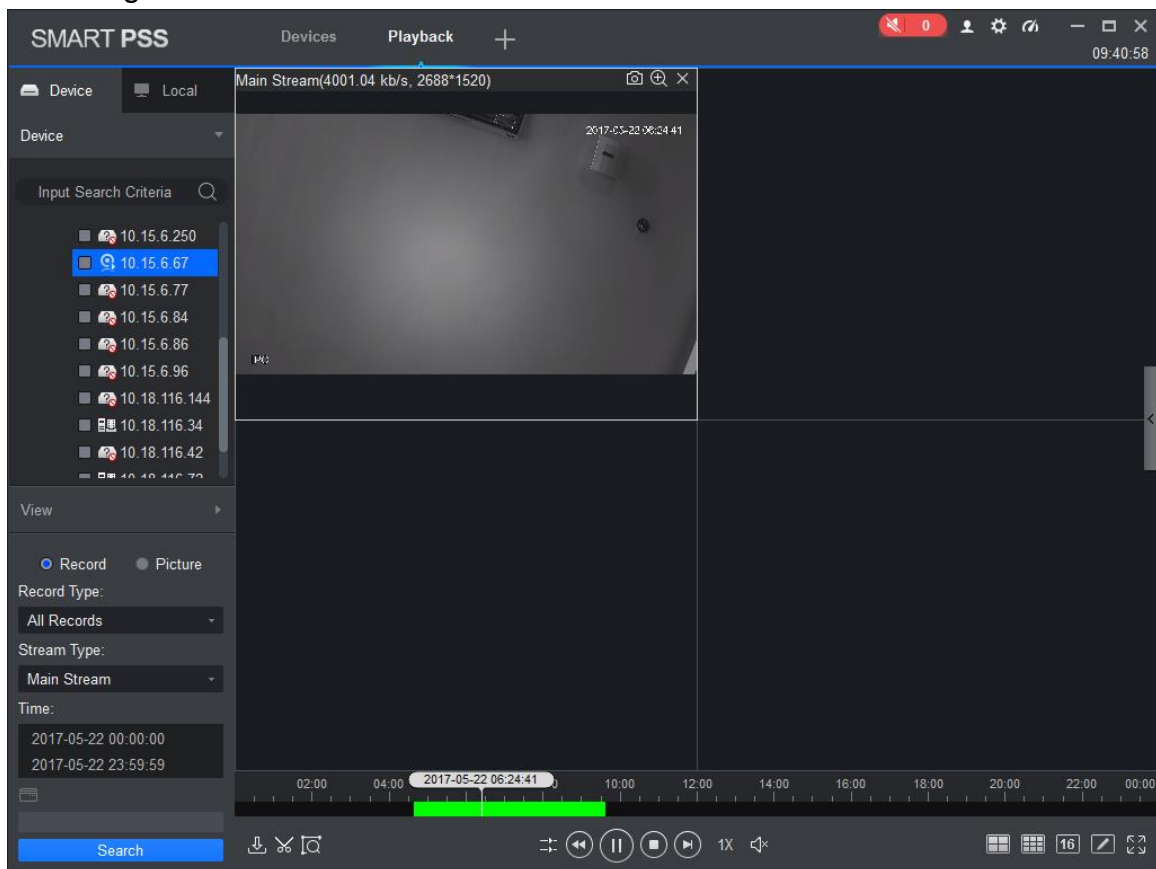

Figure 6-2

6.3 Export Device Record

Condition

There is device record inside channel.

Steps:

Step 1. In playback interface, click Device tab.

Step 2. In Organization Tree, select device channel or select view in View.

Step 3. Set record search criteria.

- a) Select record type and stream, and set time.
- b) Click Search.

Step 4. Select window with record, click .

Step 5. Click , system select one record, and adjust record part according to actual need,

click  again to export record. See Figure 6-3.

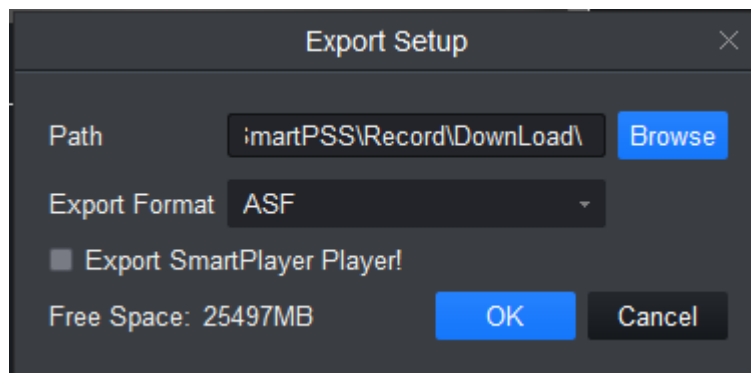

Figure 6-3

Step 6. Select export path and format.

Note:

When the Export Format is set to Original Format, please also check the Export Smart Player, export original format player.

Step 7. Click OK.

The system displays the playback stop information, click OK.

The system displays the Export Progress dialog box, as Figure 6-4 below.

After recording the download is complete, the system prompts the download is complete.

Click Exporting tab, user may view the video download progress, pause the video being exported to continue downloading the paused video, download again the video failed and delete exporting video; click exported tab, user may view download history and open video storage path.

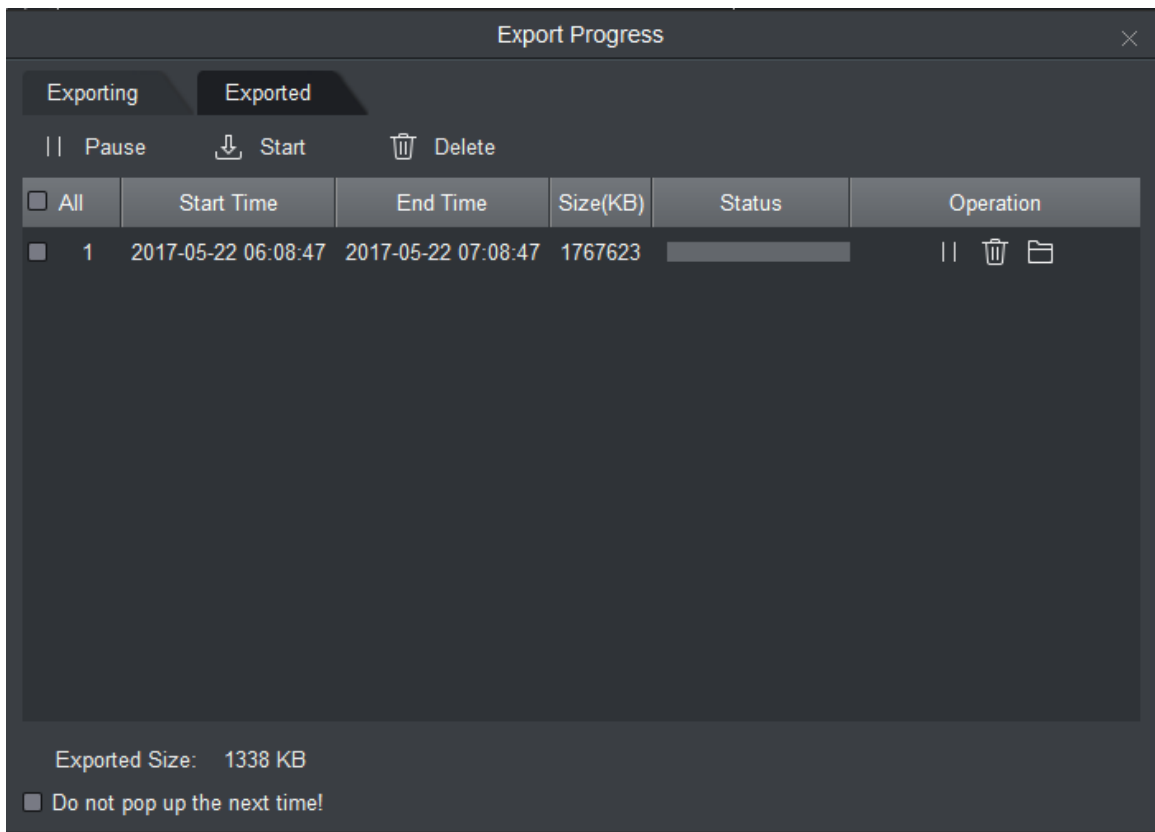

Figure 6-4

6.4 Playback Device Picture

Condition

There is device picture inside channel.



Steps

Step 1. In Playback interface, select Device tab.

Step 2. In Organization Tree, select device channel or in View select view.

Step 3. Select picture and set time. See Figure 6-5.

Click  on the right, user may open and close device picture list.

In device picture list, click , device picture list will be shown in format of list; click , device picture list is shown in format of thumbnail.

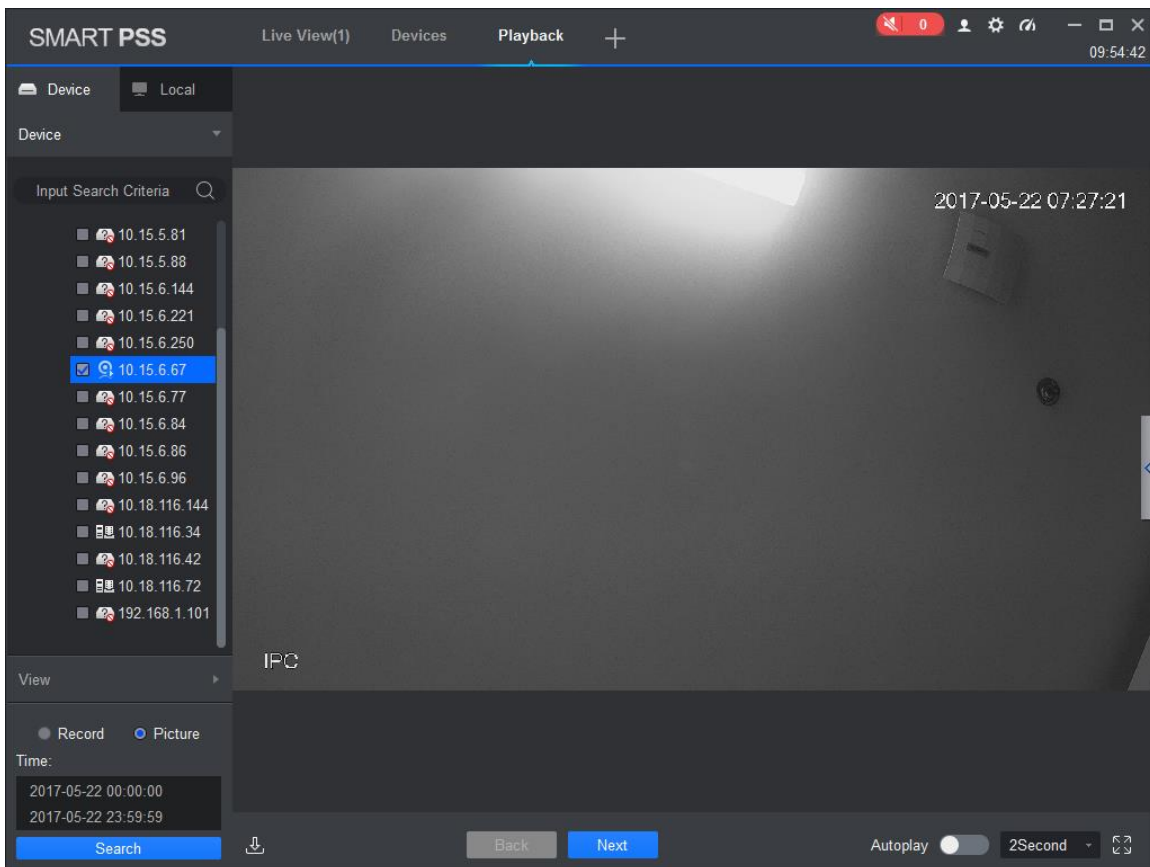



Figure 6-5

Step 4. Playback picture.

- Manual playback: Click Next or Preview.
- Auto playback: Set auto play interval, click  to auto play(it switch to ) , system will auto playback local picture.

6.5 Export Device Picture

Step 1. In Playback interface, select Device tab.

Step 2. In Organization Tree select device channel or in View select view.

Step 3. Select Picture and set time.

Step 4. Click  on the right, to export device picture.

Step 5. Click . See Figure 6-6.

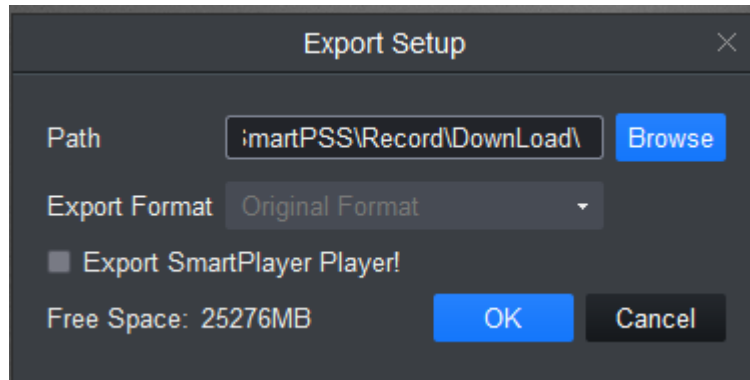

Figure 6-6

Step 6. Select export path, click OK. See Figure 6-7.

Click Exported tab, user may view download record, open picture storage path and delete downloaded file.

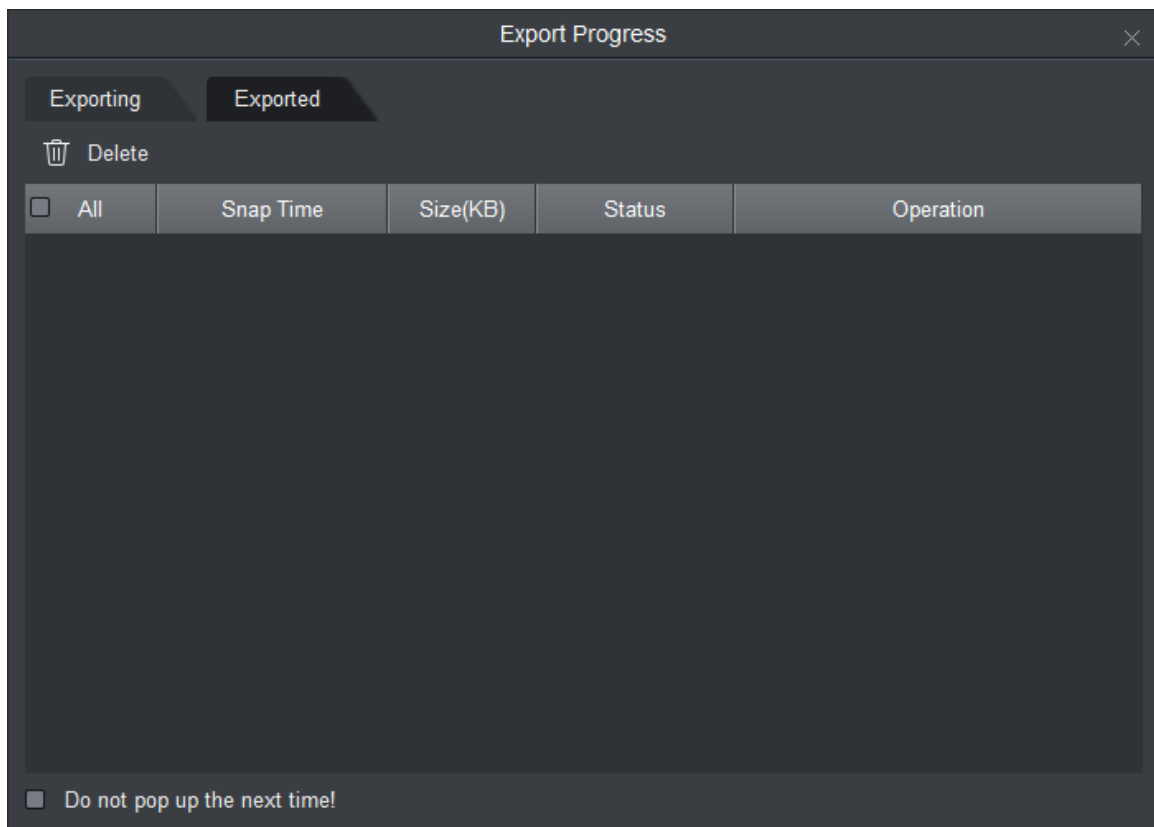

Figure 6-7

6.6 Playback Local Record

Condition



There is local record in the channel, see Ch 4.1.

Steps

Step 1. In Playback interface, select Local tab.

Step 2. Click Record tab.

System shows local record list.

In local record list, click , display in list mode. Click , display in thumbnail mode.

Step 3. Select record to playback, click  or double click record.
See Figure 6-8.

Note:

User may click  to open local record file for playback.

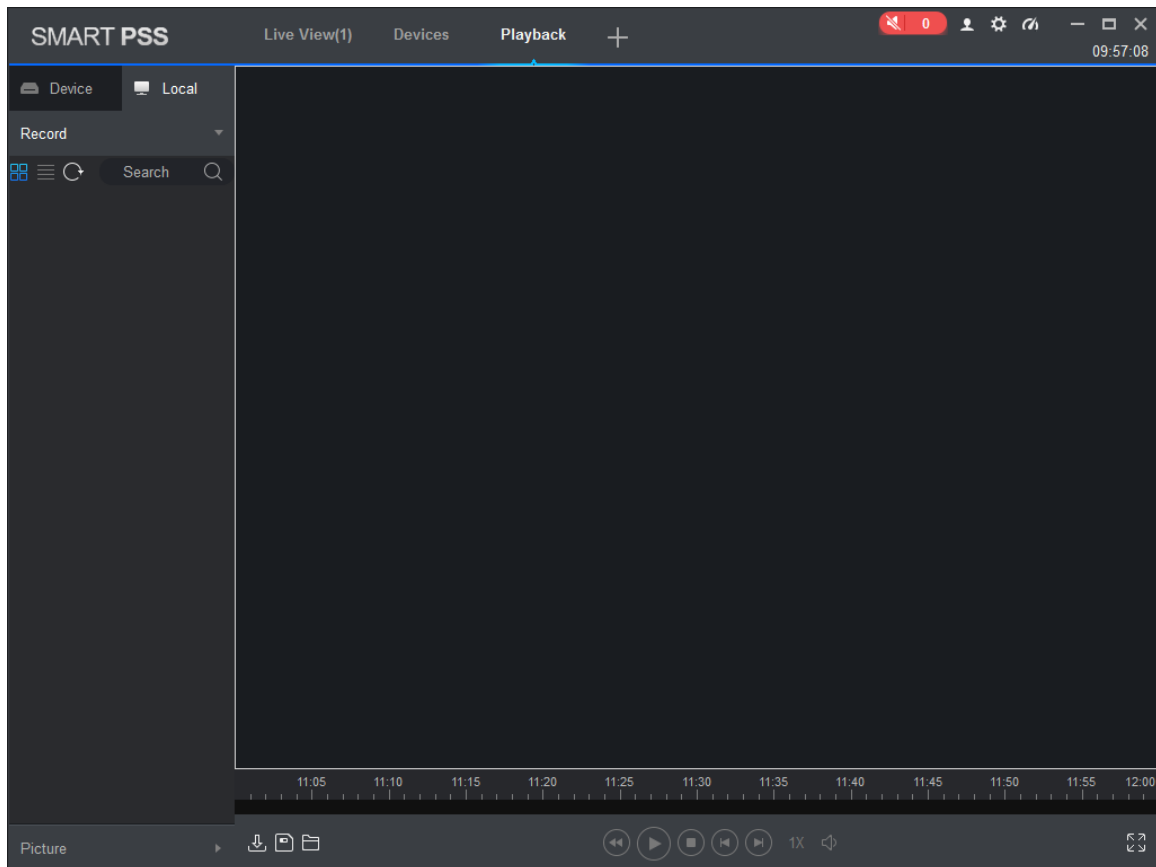

Figure 6-8

6.7 Export Local Record

User may export local record.

Condition

There is local record in this channel, see Ch 4.2.

Steps

Step 1. In Playback interface, click Local tab.

Step 2. Click Record tab.

Step 3. Check record to export, click . See Figure 6-9.

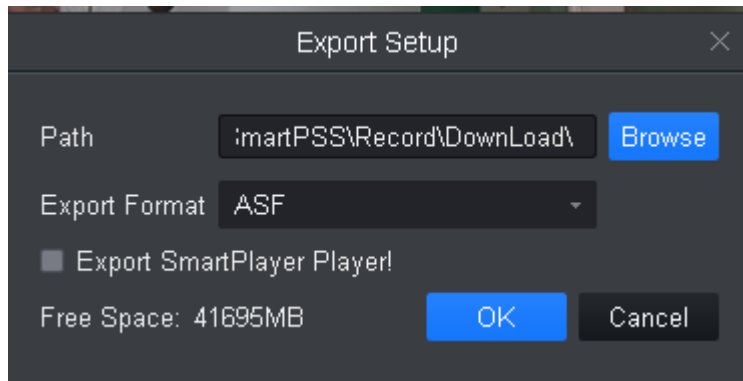

Figure 6-9

Step 4. Select export path and format.

Note:

When Export Format is set to Original Format, please check Export Smart Player to export.

Step 5. Click OK.

The system displays the Export Progress dialog box, as Figure 6-10 shown.

After record download is complete, the system prompts the download is complete.

Click Exporting tab, user may view the video download progress, pause the video being exported, resume download paused, and delete videos which being exported; click Exported tab, user may view the download history, open video storage path and delete the downloaded file.

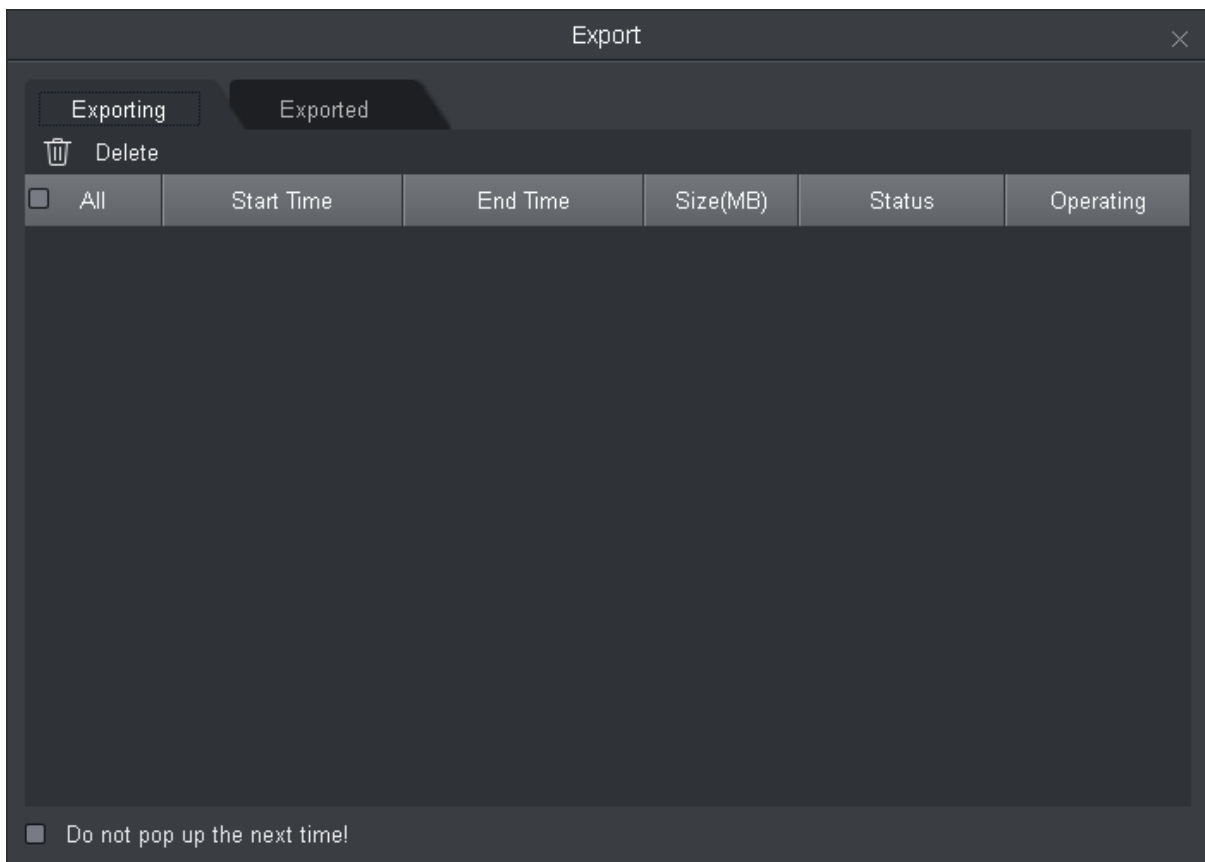

Figure 6-10

6.8 Playback Local Picture

Condition



There is local picture in the channel, see Ch 4.1.

Steps

Step 1. In Playback interface, select Local tab.

Step 2. Click Picture tab.

System shows local record list.

In local picture list, click , display in list mode. Click , display in thumbnail mode.

Step 3. Select picture to playback, click  or double click picture
See Figure 6-11.

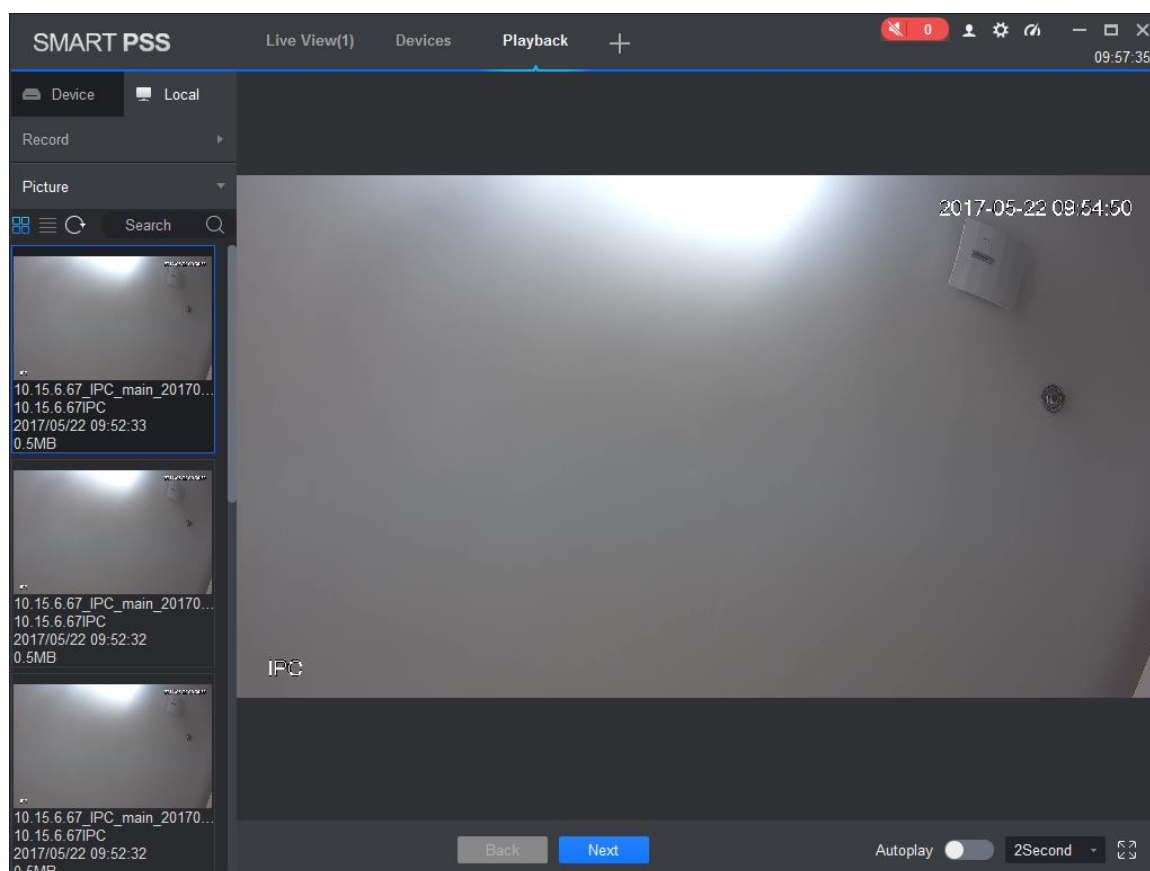



Figure 6-11

Step 4. Playback picture.

- Manual playback: Click Next or Preview.
- Auto playback: Set auto play interval, click  to auto play(it switch to ) , system will auto playback local picture.

7. Log Search

7.1 Search Client Log

Step 1. In New tab, click Log.

Step 2. Select . System shows Client interface.

Step 3. Set time, type, keyword. Client log includes system log, operation log and alarm log.

Step 4. Click Search. See Figure 7-1.

Note:

After log is successfully searched, user may click Export to export log.

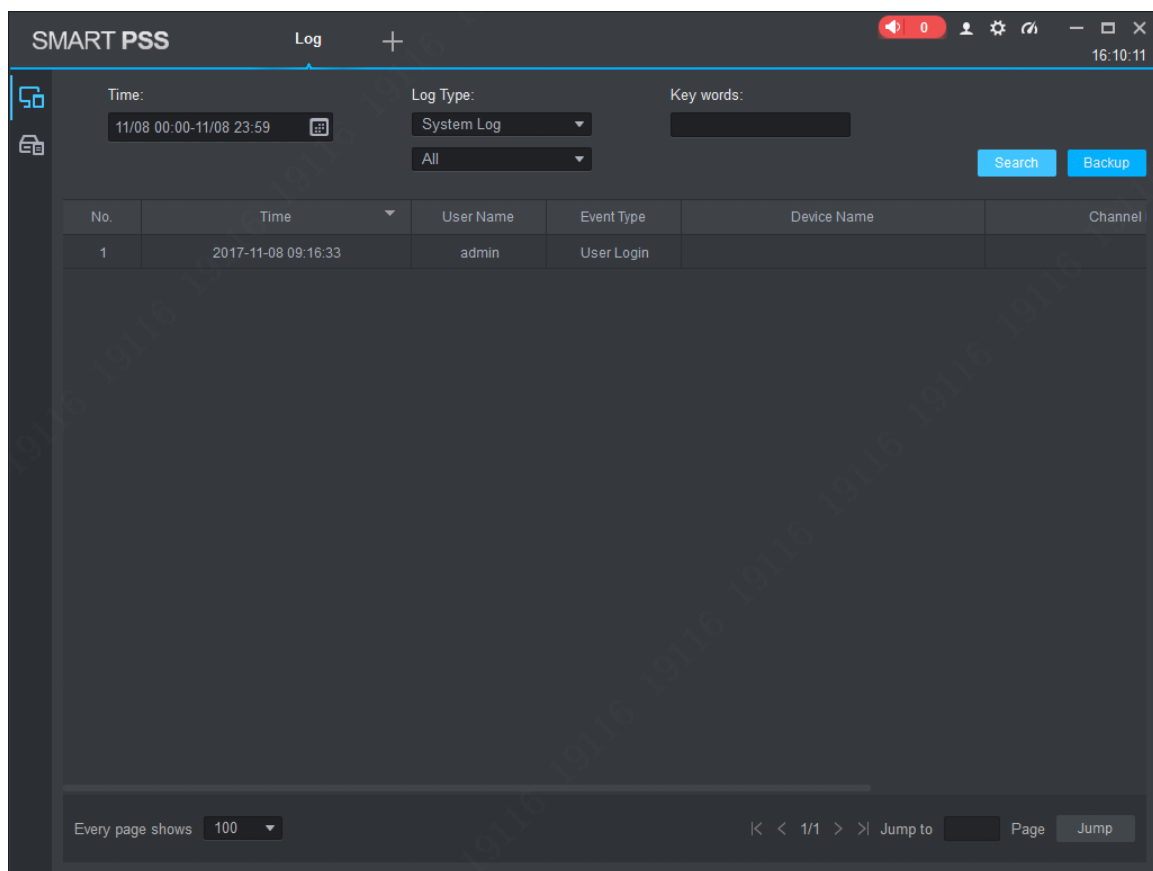

Figure 7-1

7.2 Search Device Log

Step 1. In New tab, click Log.

Step 2. Select .

Step 3. Set time, type, and device. Client log includes system log, config log, storage log and etc.

Step 4. Click Search. See Figure 7-2.

Note:

After log is successfully searched, user may click Export to export log.

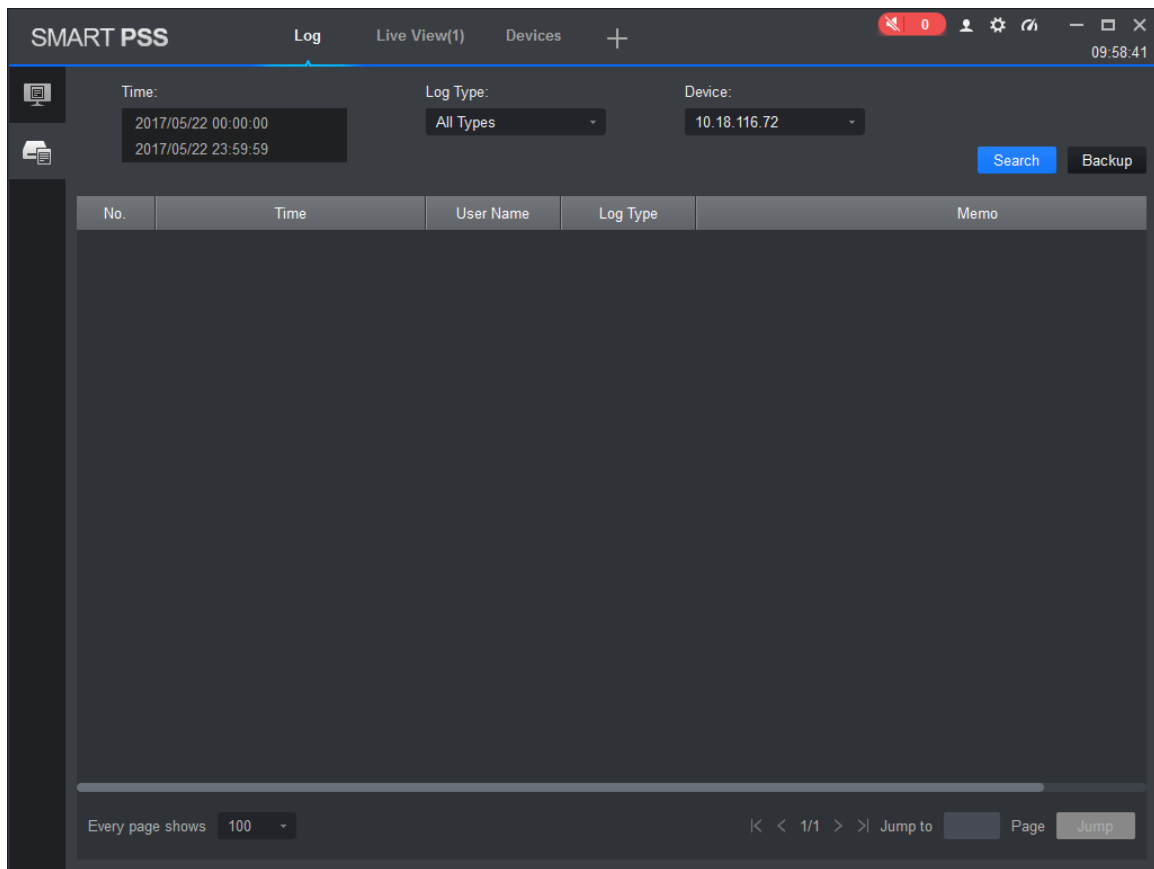

Figure 7-2

8. System Config

User may set up base info, preview and playback, event, log, system and language, hot keys, and local path, backup/restore.

Step 1. In homepage, click . See Figure 8-1.

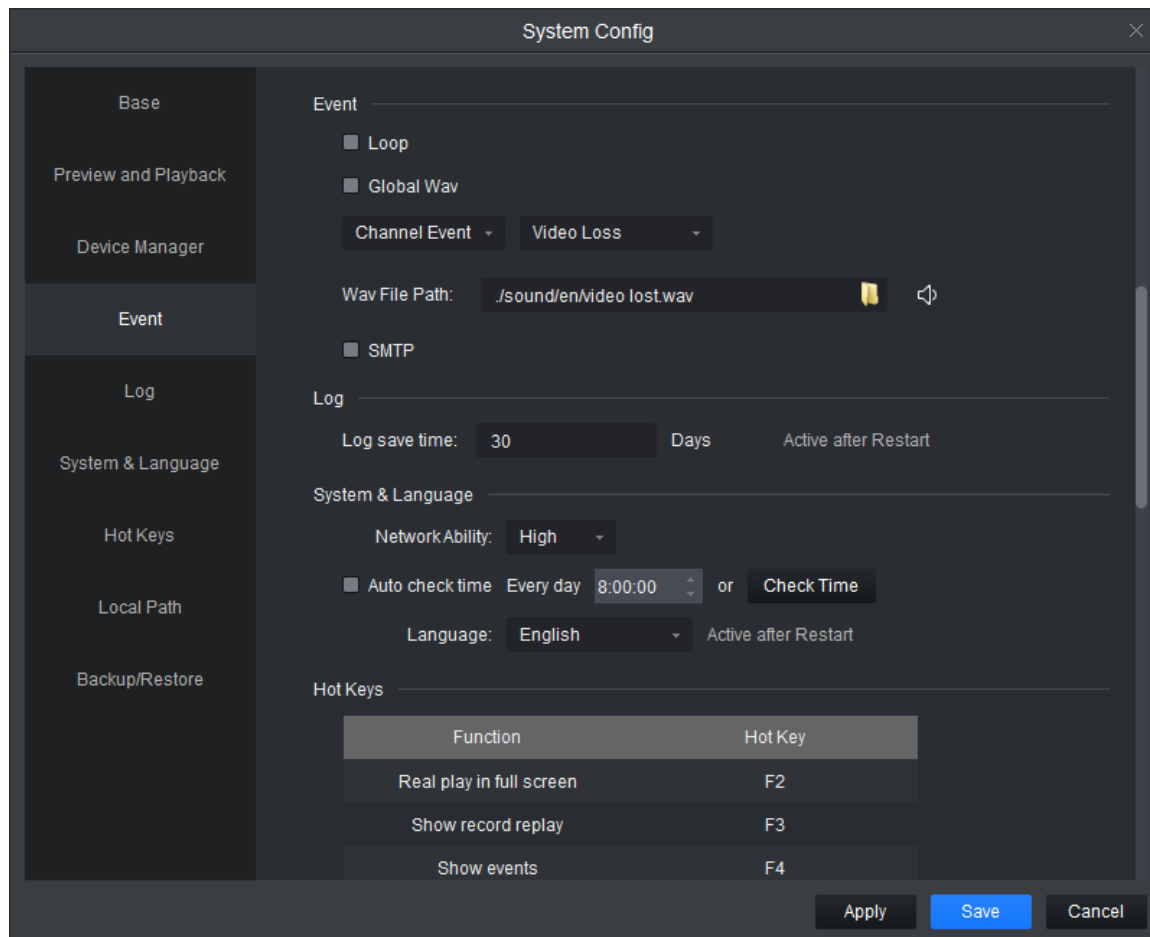

Figure 8-1

Step 2. Set parameters, see the following chart.

| Parameter Type | Parameter | Note |
|----------------|---------------------|--|
| Base | Initial page | Select page shown when you open the software, including new feature page preview interface and will recovery not closed tabs |
| | Maximum behavior | Maximize display software, including full screen and maximized window. |
| | Minimum behavior | Check show floating window, display floating window when the software is minimized. |
| | Default video scale | Set the preview or playback video default ratio, including the original scale and full screen. |
| | Default device | Set the preview, playback and other interface devices tree |

| | | |
|----------------------|----------------------------|---|
| | tree | display formats. Modify this parameter to take effect after the restart the software needed. Include following options: <ul style="list-style-type: none"> ● Device tree (according to device): grouping by device ● Area tree (according to channel): grouping by channel |
| | Audio NE Level | Set audio NE level within 1~5. |
| Preview and Playback | Default Stream Type | Set stream type of preview, including mains stream, sub stream, and self-adaptive stream. |
| | Instantly Replay Time | Set at time instant replay of the preview screen. |
| | Resume last preview | Check the Resume last preview software record video window status when closing software, and after re-login open the preview screen, the video will be restored as before the software is closed. |
| | Show IVS Rule | Show IVS rule in preview and playback video. |
| | Save Device Tree Selection | Select Save Device Tree Selection, after record search end, device will keep selected status. |
| Device | Show device channel number | Check the Show device channel number, then in Device interface software automatically assigns a unique no. to device, user may modify this no. This no.of device is used for keyboard. |
| | Auto login device | Check the Auto login device, restart the software, the software automatically logged added device. Modify this parameter to take effect after the restart the software as needed. |
| | Auto fill user and key | Check the Auto fill user and key, enter your username and password, the software automatically login added device according to the username and password. If the login username and password set are the same as user and password of the device, then login is successful, otherwise the login fails. |
| Event | Loop | Check the Loop, looping alarm when an event occurs. |
| | Global wav | <ul style="list-style-type: none"> ● Check the Global wav, select audio file path, then all alarms shall play the audio file. ● Not check the Global wav, select different types of events and events in the drop-down list, and separately set their corresponding audio file. |

| | | |
|---------------------|-----------------|--|
| | SMTP | Enable SMTP (email) and set email info, when an event occurs, it will send an email. |
| Log | Log saved time | Setting the log storage time, modification to this parameter will be effective only after this software is restarted. |
| System and Language | Network ability | Set the network according to actual network performance. |
| | Auto check time | Check the Auto check time, and set the corresponding point in time, when the software is open during sync time, and device added on client automatically synchronize with your local PC time. |
| | Check time | Click Check time, device added on client immediately synchronization time. |
| | Language | Set the language of the software, modify this parameter to take effect after the restart the software as needed. |
| Hotkeys | | <p>Set shortcut keys for common operations systems. Double click the hotkey column in the corresponding function of the hotkey, then set the hotkey function on the keyboard, click the Apply, modify the corresponding hotkey function.</p> <p>Click Reset to restore default software.</p> <p>Common operations include preview full-screen, open playback module, open event module, open system configuration, open tour plan configuration, enable/disable tour plan, snapshot, lock, switch users, open / close linkage video, turn on / off video .</p> |
| Local Path | Pic path | Set picture path. |
| | Record path | Set record path. |
| Backup/Restore | Backup | Click Backup to back up config file, |
| | Restore | Click Restore, and select exported config file to restore config. |

Step 3. Click Save.

9. User

9.1 Role Info

User may add, modify and delete role.

Step 1. In New tab, click User, see Figure 9-1.

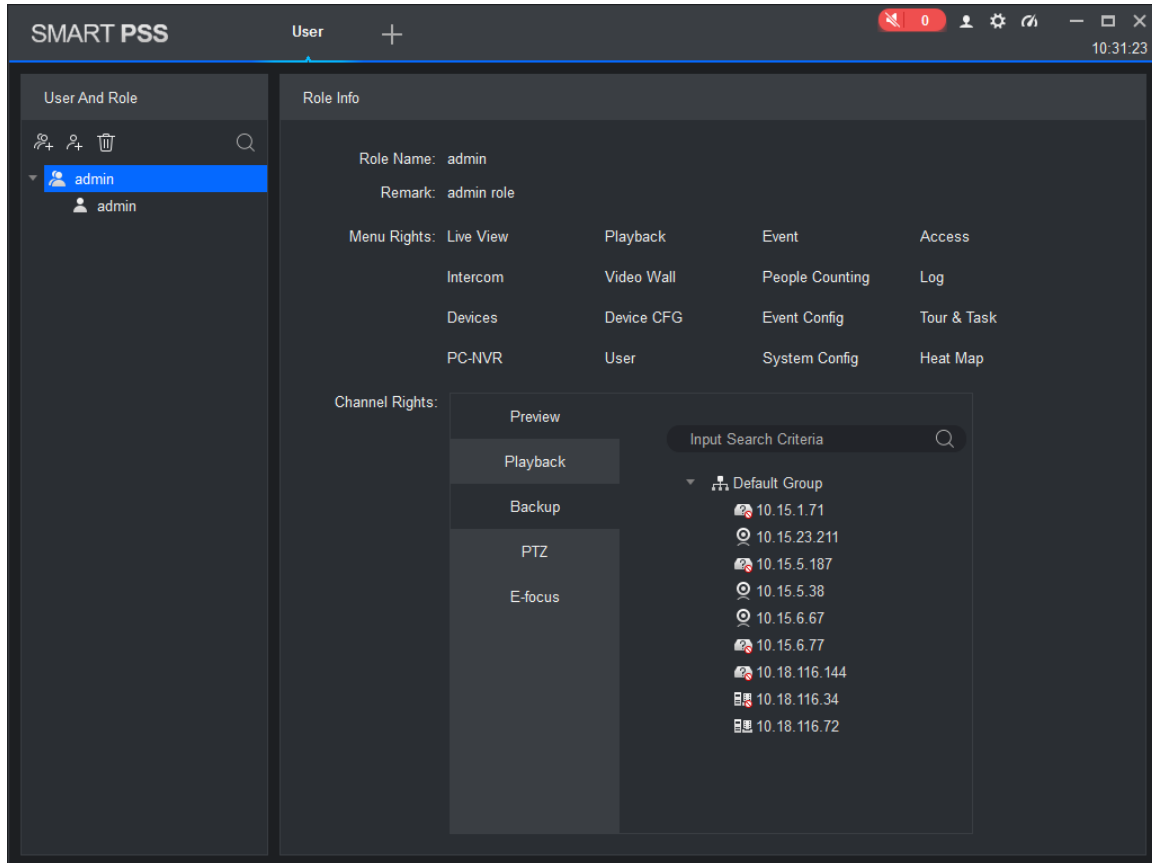

Figure 9-1

Step 2. Click . See Figure 9-2.

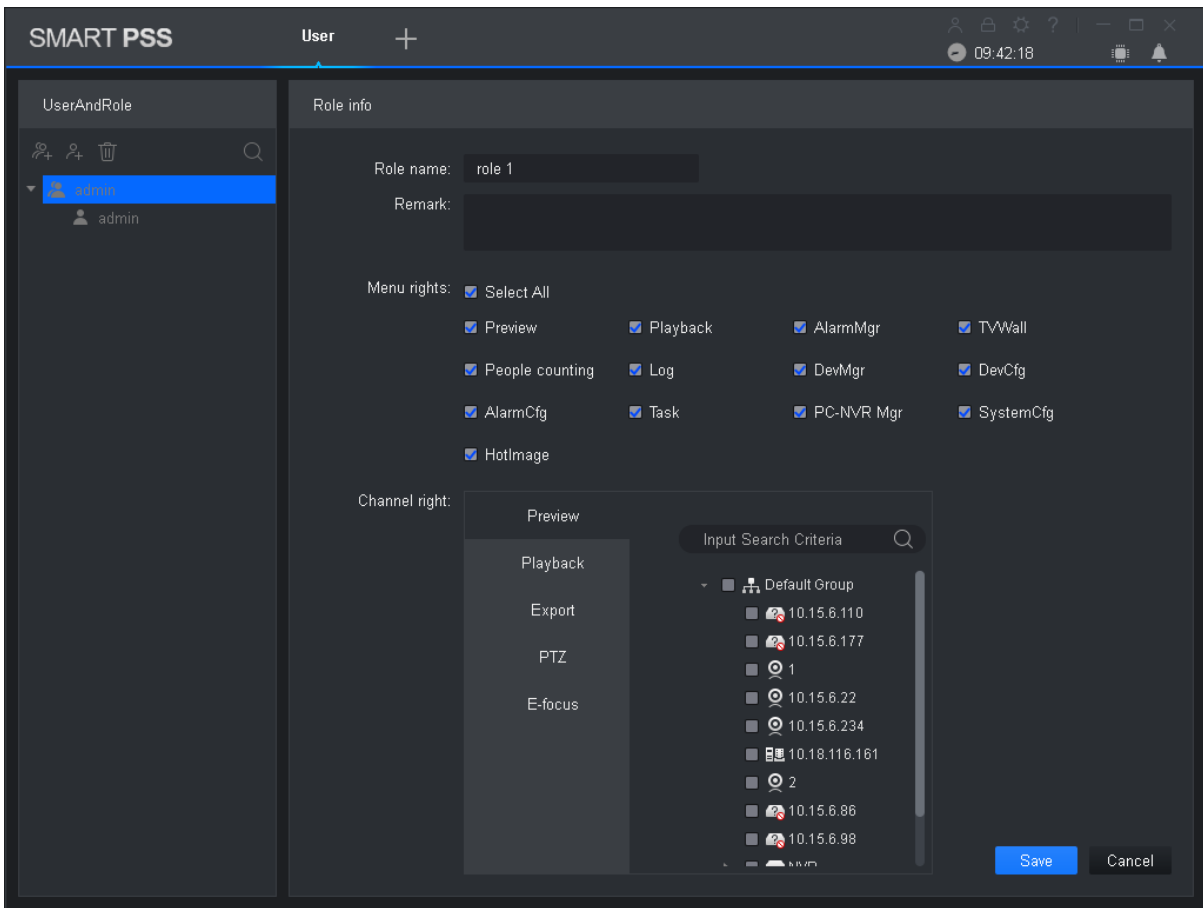

Figure 9-2

Step 3. Set role name and fill in remark.

Step 4. Check menu right of the role, and select tab and set role channel right in Channel right area.

Note:

When user of the corresponding role logs in client, and in New tab it does not show non-allocated menu right, and in corresponding device tree it does not show non-allocated channel right.

Step 5. Click Save.

Note:

Admin has all rights which cannot be modified or deleted. After a role is added, user may modify its right or delete it.

Warning:

When you delete a role, users of this role will also be deleted.

9.2 User

User may add, modify and delete user.

Step 1. In New tab, click User. See Figure 9-3.

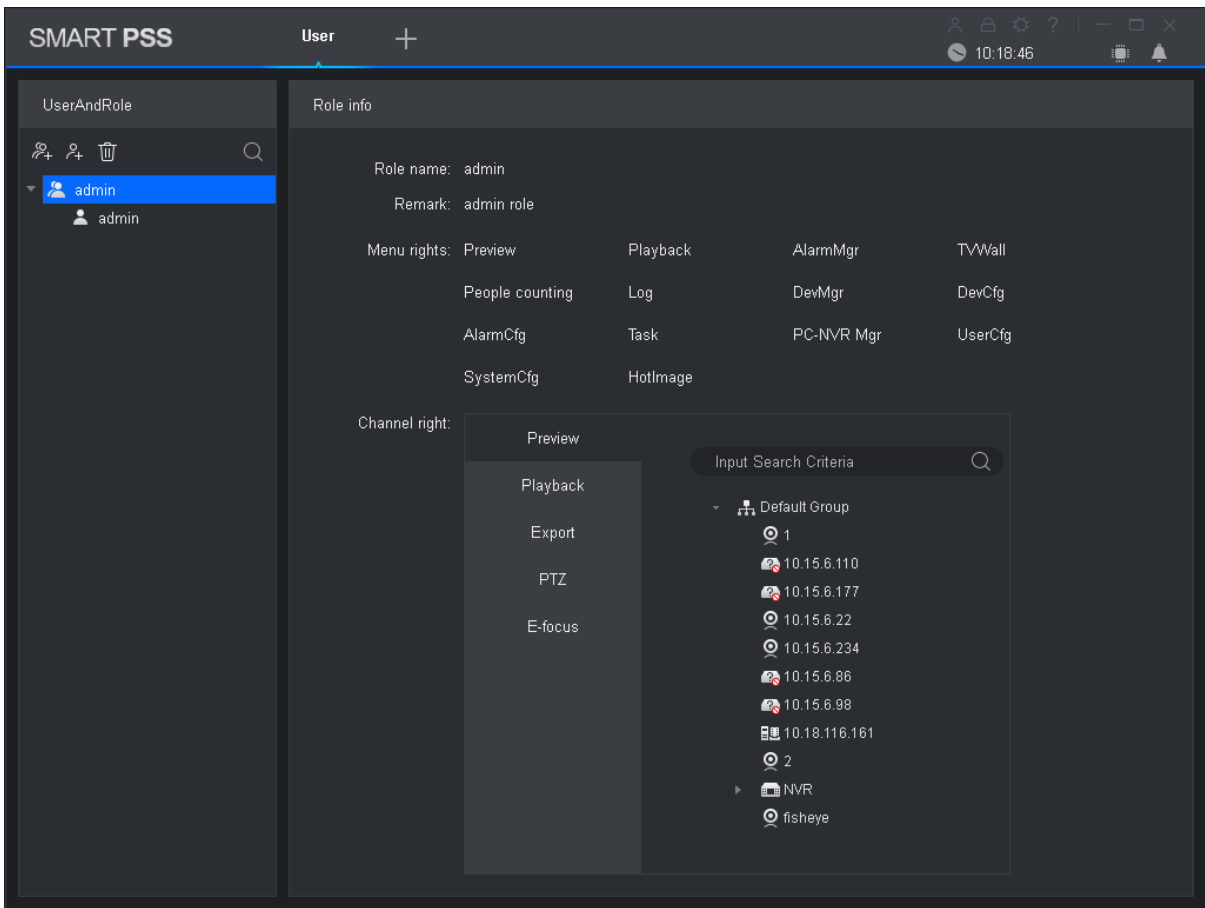

Figure 9-3

Step 2. Select role which you want to add user. See Figure 9-4.

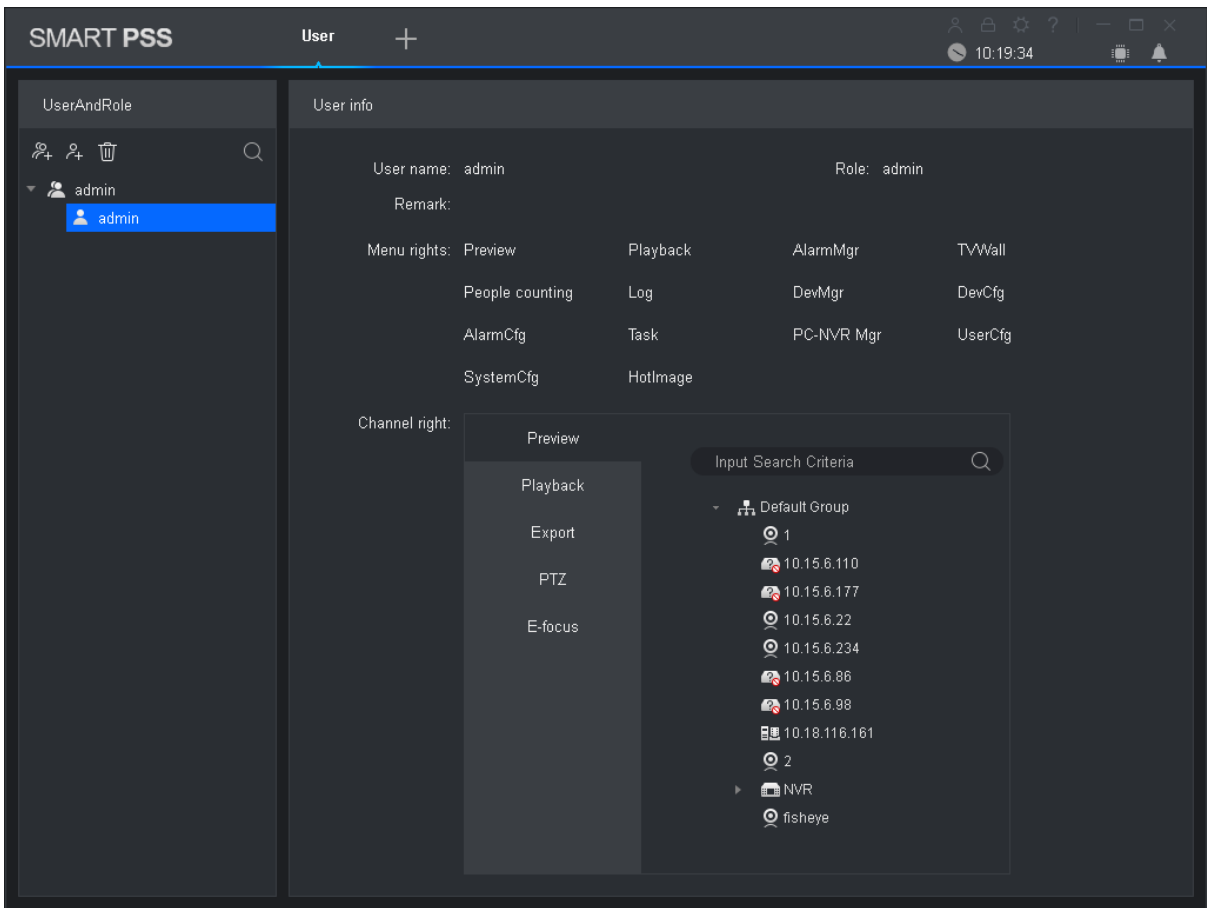

Figure 9-4

Step 3. Set user parameter, see the following chart.

| Parameter | Note |
|----------------|---|
| Username | Username which cannot repeat existing username. |
| Role | Select a role the user belongs. Different user permissions are for different roles. |
| Password | The user's password and confirm the password. |
| Confirm | |
| Remark | Description of the user information. |
| Menu rights | According to the actual need select the user's menu rights |
| Channel rights | According to the actual need select the user's channel rights |

Step 4. Click Save.

Note:

Admin has all rights which cannot be modified or deleted. After a role is added, user may modify its right or delete it.

10. Device Config

User may update software, connect to WEB, configure device camera, network, PTZ, event, storage, system and etc.

In New tab, click Device CFG, see Figure 10-1. Different devices may have different parameters, subject to actual device and manual.

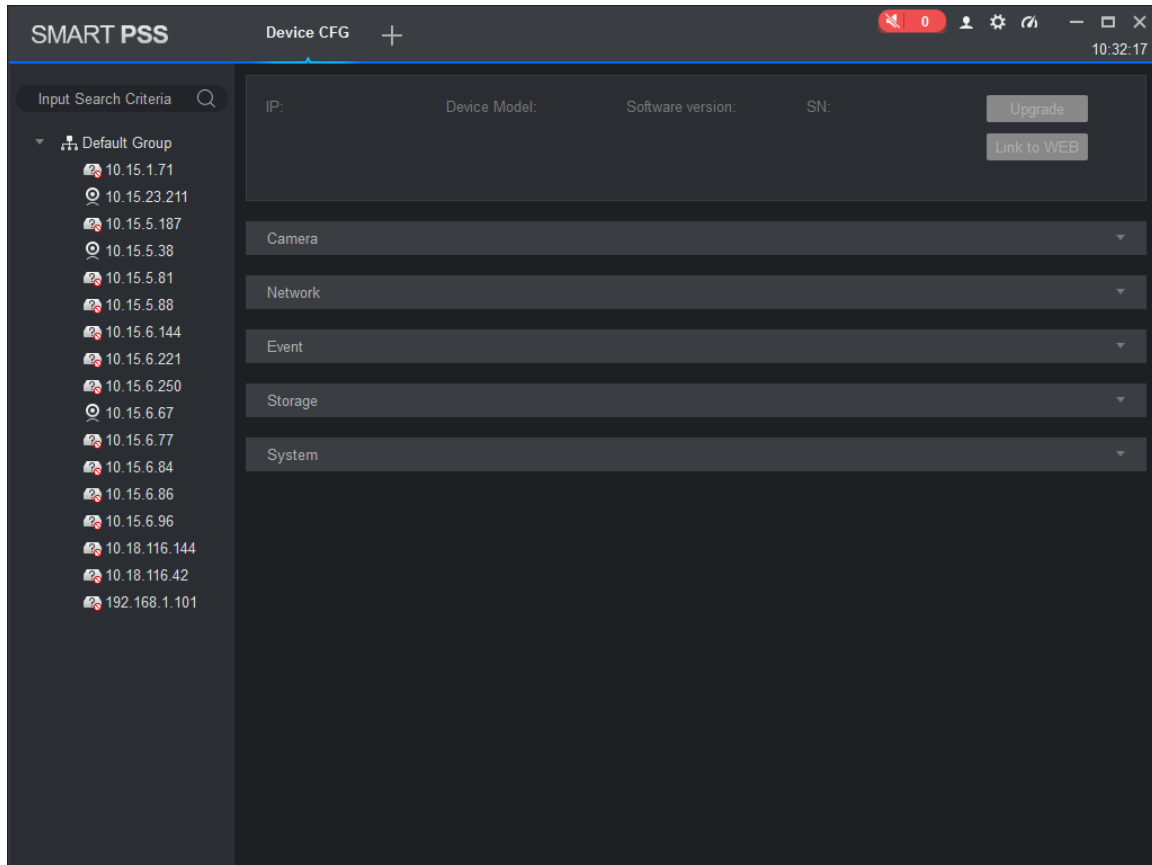

Figure 10-1

| No. | Task | Note |
|-----|-------------|--|
| 1 | Device | Select device, user may view the device's IP address, device model, software version and serial number. |
| | Upgrade | Select device, click the Upgrade, user may upgrade the device program. |
| | Link to WEB | Select the device, click the Link to WEB, can be linked to WEB config interface. |
| 2 | Camera | Select device, open the Camera . <ul style="list-style-type: none"> ● Click Remote Device, user may search device and add the device or remove device. ● Click the Camera, user may configure the camera attributes, operations, management or head profile. ● Click the Video, user may configure the video code, or snapshot stream video overlay information. ● Click the Audio, user may configure the audio code stream, input type and volume. |
| | Network | Select the device, open the Network tab. |

| | | |
|--|------------------------------|--|
| | | <ul style="list-style-type: none"> ● Click TCP / IP, user may configure a static IP address of the device or the device to obtain an IP address via DHCP. ● Click Connect, user may configure the maximum number of connected devices and the port number to use when connecting. ● Click PPPOE, user may configure the PPPoE username and password to access the device via PPPoE dialing. ● Click DDNS, user may configure the device and DDNS server domain names, access device through its domain name. ● Click the IP Rights, user may configure a whitelist and blacklist devices. ● Click SMTP (e-mail), user may configure the device's SMTP server and mailbox information when the device is configured alarm linkage and alarm messages, the recipients of the message recipient to send alarm information. ● Click FTP, the device can be configured FTP upload information and pictures, pictures in the manner set upload FTP appropriate directory. ● Click Multicast, user may configure the multicast address and port, through surveillance video multicasts. ● Click Alarm Center, user may configure the alarm center host IP address and timing login time. |
| | PTZ | Select device, open PTZ tab. Click PTZ, user may configure PTZ and stimulate PTZ. |
| | Configuring event parameters | Select the device, open Events tab. <ul style="list-style-type: none"> ● Click the Video Detect, user may configure motion detection, video loss detection, video tampering detection and defocus detection. ● Click the Audio Detect, user may configure audio input and sound intensity abnormality. ● Click Intelligent Analysis, can mark video quality diagnosis, general behavioral analysis, face detection, people counting and depth of field heat map. ● Click Alarm I/O, user may configure the alarm inputs and alarm linkage information. ● Click Abnormality, user may configure no space, storage device error, IP conflict and etc. |
| | Storage | Select device, open Storage. <ul style="list-style-type: none"> ● Click Schedule, user may configure the video snapshot and snapshot plan. ● Click HDD Manager, user may configure and view locally stored information about the device, configure the FTP server. ● Click the Record, user may configure the video stream control method. |
| | System Parameters | Select the device, open the System tab. <ul style="list-style-type: none"> ● Click General, user may basic information and |

| | | |
|--|--|---|
| | | <p>time.</p> <ul style="list-style-type: none">• Click PTZ, user may configure the analog PTZ information.• Click Account, user may add, delete users and user groups.• Click Maintenance, user may configure serial information, system configuration and maintenance information plus view version information. |
|--|--|---|

11. Event Config

11.1 Event Type

In New tab, click Event Config, see Figure 11-1.

Note:

Client shows all event types, different devices support different event types, subject to actual device.

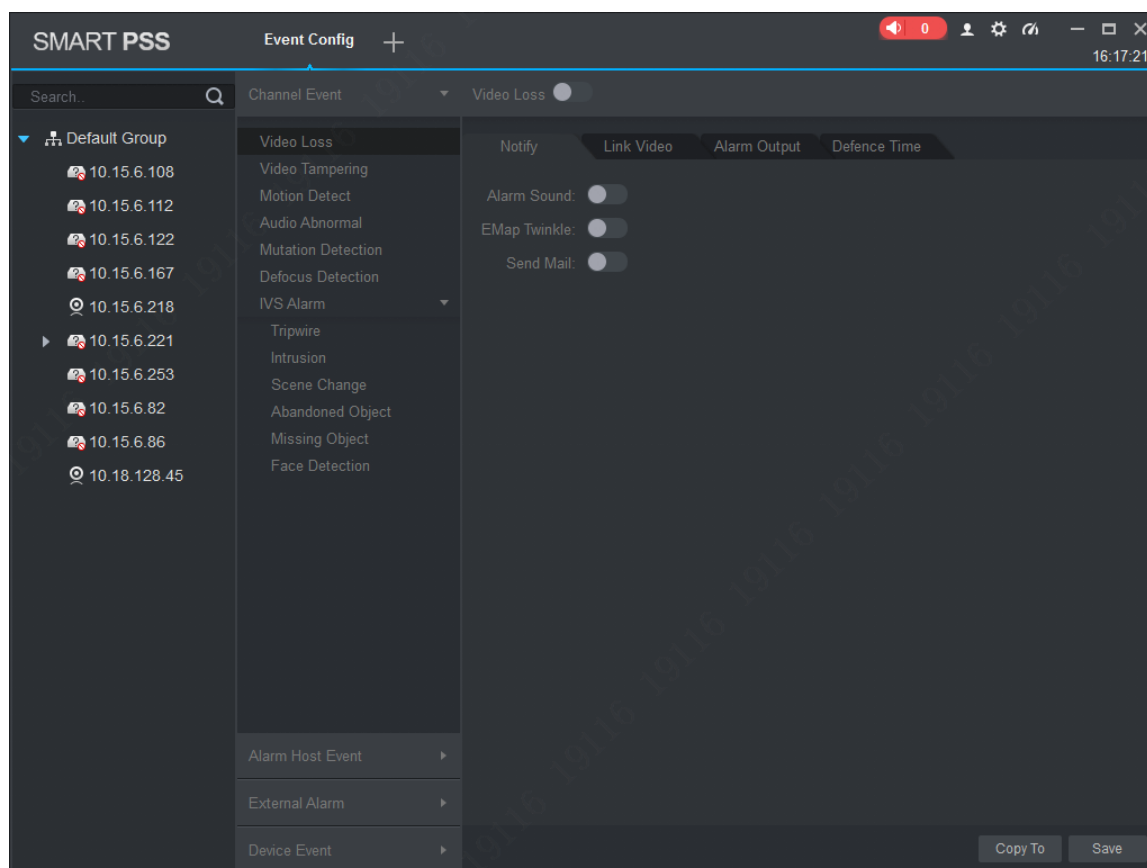

Figure 11-1

| The event type | Event | Note | Condition |
|----------------|-----------------|--|-----------------------------|
| Channel event | Video loss | Network abnormality causing video loss | Video loss detection is ON. |
| | Video tampering | Event is generated when video is tampered. | Video tampering is ON. |
| | Motion detect | Event is generated when it is detected moving object in video. | Motion detect is ON. |
| | Audio abnormal | Event is generated | Audio abnormal |

| | | | |
|--|--------------------|---|--|
| | | when the audio connection is abnormal. | is ON. . |
| | Audio mutation | Event is generated when the sound suddenly changed. | Audio mutation is ON. |
| | Defocus detect | Event is generated when defocus occurs. | Defocus detect is ON. |
| | IPC External Alarm | For only NVR/HCVR. Check external alarm input of IPC connected to NVR/HCVR. | N/A |
| | IPC Offline Alarm | For only NVR/HCVR. Check event occurs when IPC disconnected to NVR/HCVR. | N/A |
| | IVS Alarm | Tripwire | Event is generated when the target cross line from set direction. |
| | | Cross warning zone | Event is generated when the object enters or leaves the area, or the target appears in the region. |
| | | Scene switch | Event is generated when the scene changes. |
| | | Abandoned object detection | Event is generated when the monitor screen have left more than the target time set by the user. |
| | | Missing object detection | Event is generated when the monitor screen after the target is removed over a certain time. |

| | | | | |
|----------------|--|----------------------------|---|--|
| | | Face detection | Event is generated when the monitor screen detects the person's face. | Face detection is ON. |
| | | Loitering detection | Event is generated when the target continuously present in the monitored area longer than the set time. | Loitering detection is ON. |
| | | Crowd gathering estimation | Event is generated when the crowd gathered in monitor area or crowd density is too large. | Crowd gathering estimation is ON. |
| | | Fast moving | Calculate target actual speed and when target moving speed exceeds the set speed, event is triggered. | Fast moving is ON. |
| | | Parking detection | Event is generated when the vehicle in stationary time exceeds a set time. | Parking detection is ON. |
| External event | Alarm input 1 to input n N are different according to device alarm input structure. | | Event is generated when there is external alarm input. | Device has alarm input interface. |
| Device Event | No disks | | Event is generated when the device does not have storage devices. | No disks is ON (SD card or hard disk). |
| | Disk fault | | Event is generated when the device has hard disk failures. | Disk fault is ON. |
| | Disk full | | Event is generated when the device disk is full. | Disk full is ON. |
| | Illegal access | | When the login password you enter are consecutively | Illegal access is ON. |

| | | | |
|------------------|-----------------------|--|-----|
| | | incorrect, and reach the limit, event is triggered. | |
| | Device Offline | Event occurs when device is offline. | N/A |
| | Voltage Alarm | Check IPC voltage, when voltage is higher or lower than preset, trigger alarm. | N/A |
| Alarm Controller | Power Failure | Trigger alarm when power has failure. | N/A |
| | Low Battery | Trigger alarm when battery is 0%. | N/A |
| | PSTN Power Off | Trigger alarm when PSTN is offline. | N/A |
| | Disk Full | Trigger alarm when disk is full. | N/A |
| | Bad Disk | Trigger alarm when disk is bad. | N/A |
| | Emergency Alarm | Trigger alarm when emergency occurs. | N/A |
| | Extension Module Loss | Trigger alarm when extension module is lost. | N/A |
| | Arm/Disarm Change | Trigger alarm when arm/disarm changes. | N/A |
| | Bypass Mode Change | Trigger alarm when bypass mode changes. | N/A |
| | Vandal-proof Alarm | Trigger alarm when device is removed from installation position. | N/A |

11.2 Event Alarm Link Config

11.2.1 Link Notice

After set link notice, when event occurs, it will alarm or alarm flash on map.

Step 1. In New tab, click Event CFG.

Step 2. Click device and select event type.

Step 3. Slide  to turn on event, click Notify tab.

Step 4. Click Notify tab. See Figure 11-2.

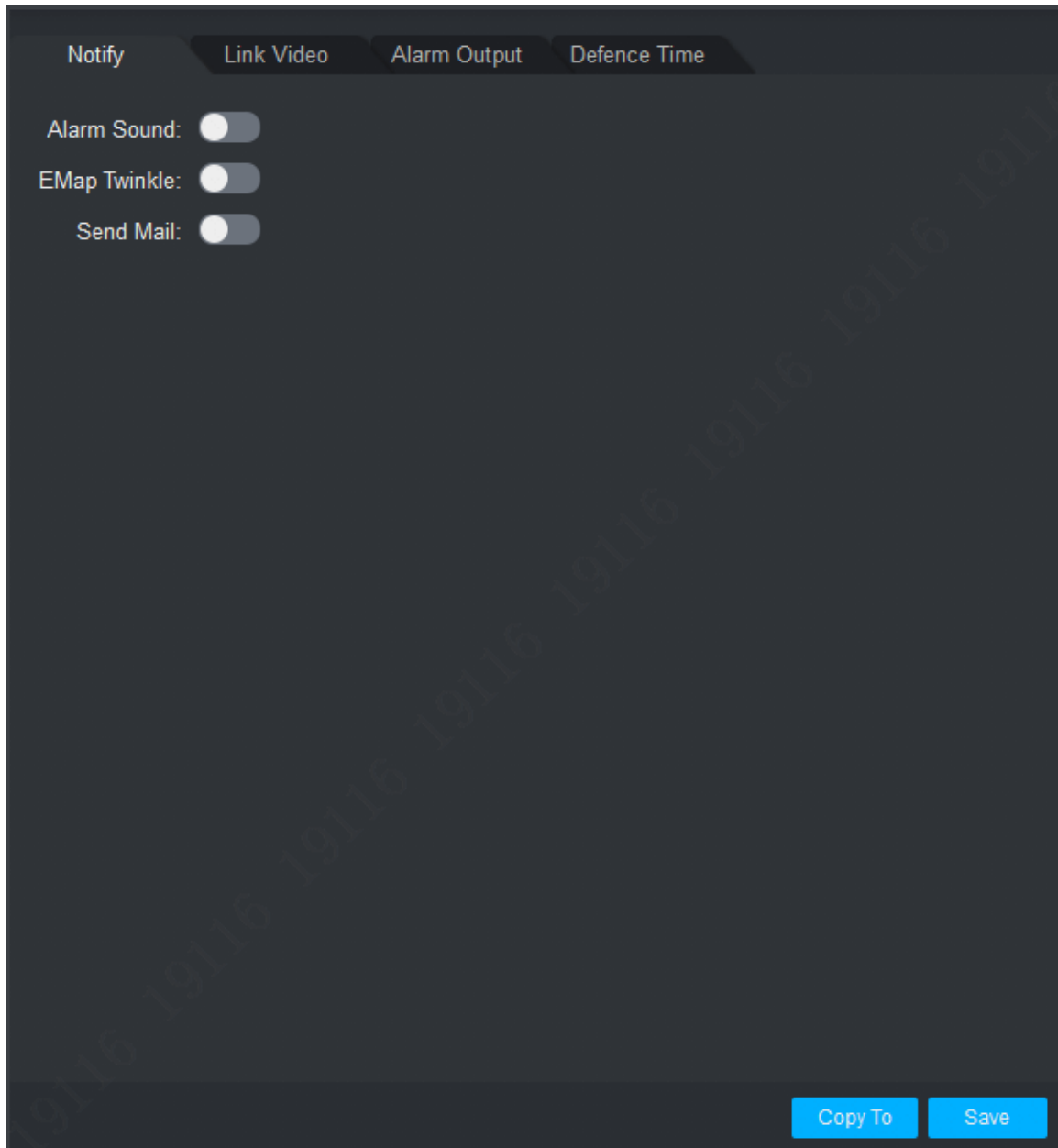

Figure 11-2

Step 5. According to need, slide  to enable alarm sound or map flash.

Step 6. Click Save.

Click Copy to, user may link config of this camera to other device.

11.2.2 Link Video

After you link video, when corresponding event occurs, it will link corresponding camera preview or record.

Step 1. In New tab, click Event CFG.

Step 2. Click device and select event type.

Step 3. Slide , to enable event, and click Link Video tab. See Figure 11-3.

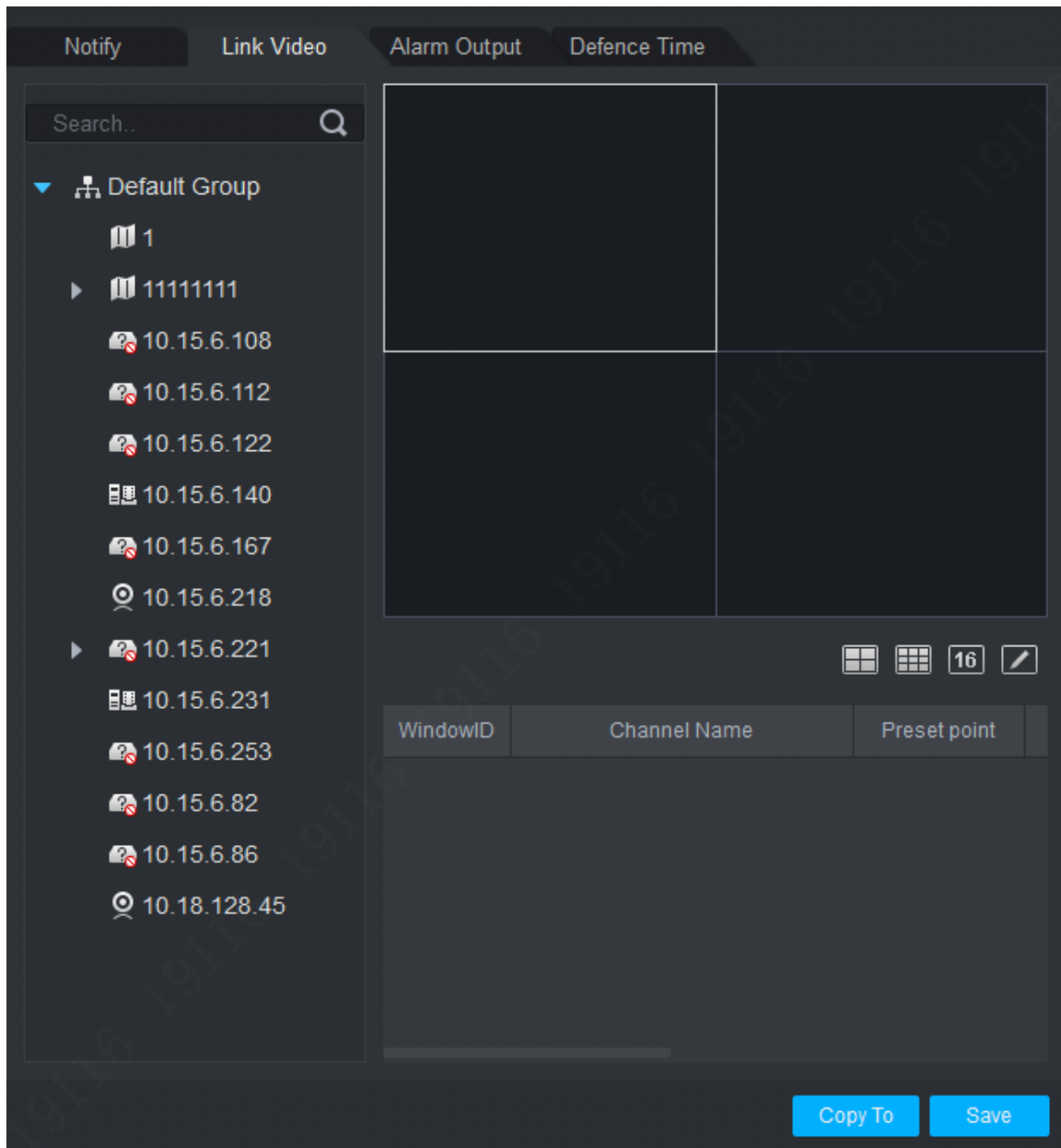



Figure 11-3

Step 4. Select video window, and double click camera you want to link, directly drag it into window.

Note:

On , user may set display mode.

Step 5. In camera list to be linked, set camera preset, link record or preview stream type, whether auto open video and enable record when event occurs, linked record or preview duration.

Note:

Click , user may delete camera.

Step 6. Click Save.

Click Copy to, user may copy camera link config to other devices.

11.2.3 Link Alarm Output

After you config link alarm output, when alarm occurs, it will link corresponding camera alarm output.

Step 1. In New tab, click Event CFG.

Step 2. Click device and select event type.

Step 3. Slide  to enable event, and click Alarm Output tab. See Figure 11-4.

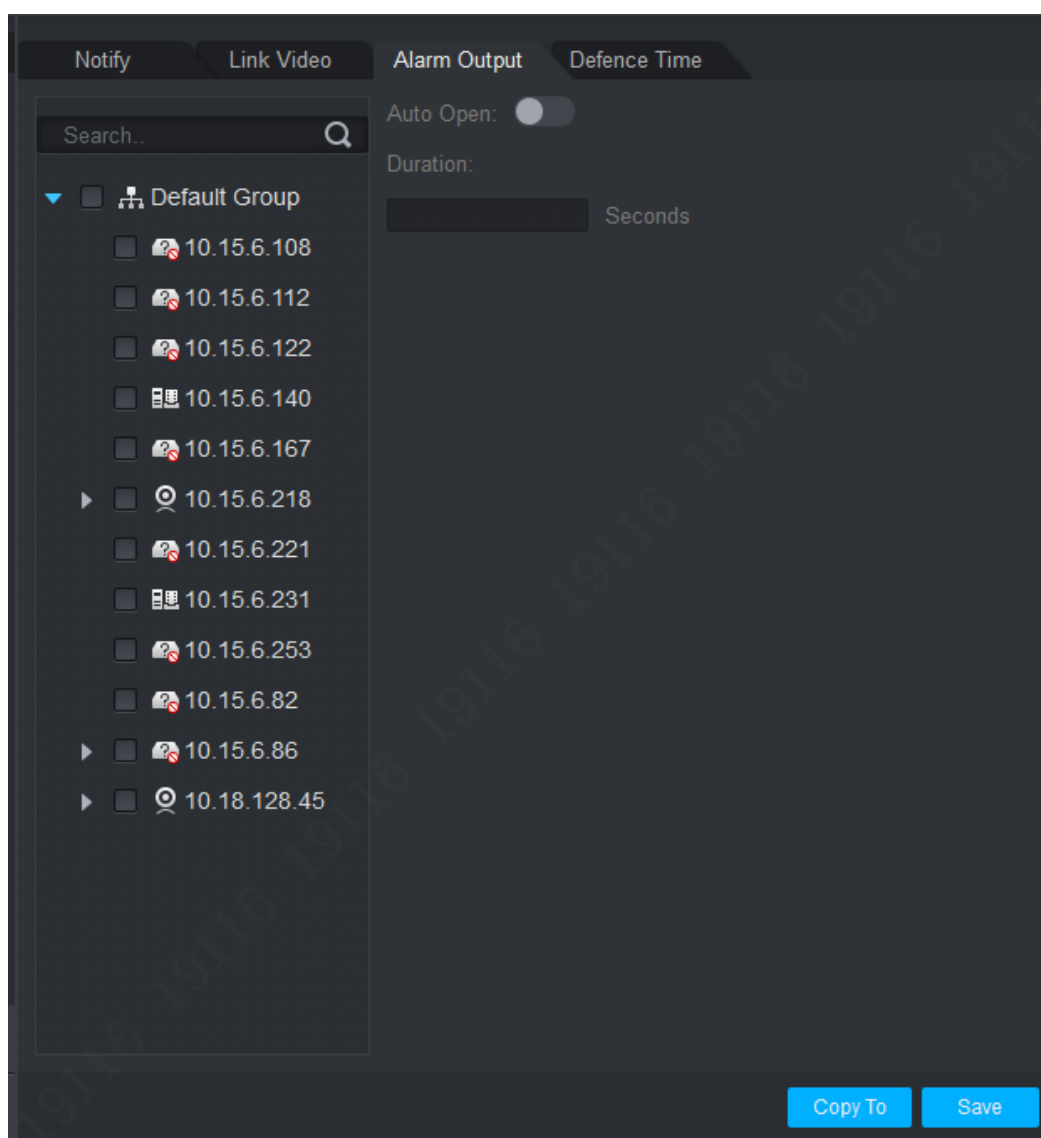

Figure 11-4

Step 4. Select alarm output of link camera and set whether to auto enable and duration.

Step 5. Click Save.

Click Copy to, user may copy camera link config to other devices.

11.2.4 Arm Time

Event is armed all-day by default. User may set arm time as needed.

Step 1. In New tab, click Event CFG.

Step 2. Click device and select event type.

Step 3. Slide  to enable event and click Arm Time tab. See Figure 11-5.,

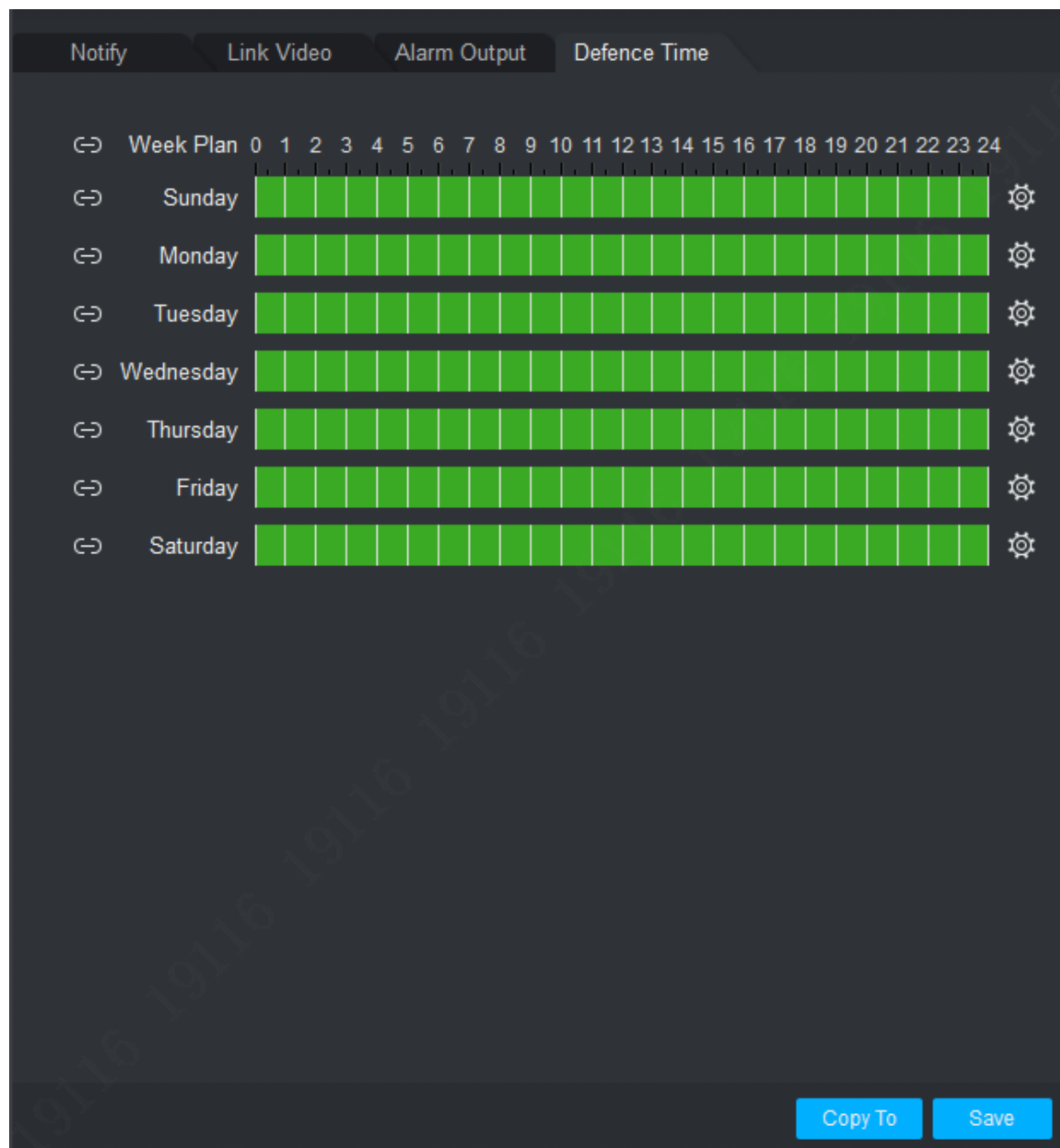



Figure 11-5

Step 4. In corresponding day of week drag mouse to delete to add arm time. You also can click

 of each day of week to set arm time in pop-up box.

Step 5. Click Save.

Click Copy to, user may copy camera arm time config to other devices.

11.3 Event View

User may view the alarm event information, disable event sounds or disable alarm linkage pop video, pause refresh of event information.

In homepage, click  or  in New tab, select the Event, see Figure 11-6.

- In the Event interface user may view real-time alarm information, view up to 1000 latest messages, please search historical alarm message in log, see Ch 7.
- Select event, user may check Disable sound to disable the alarm sound for event; check Stop link video popup to prohibit pop-up video; check Stop refresh to pause refresh of event.
- Select event, click the Confirm, user may add a description to the event.
- After you handle event or confirm event, user may not change the status of the event.

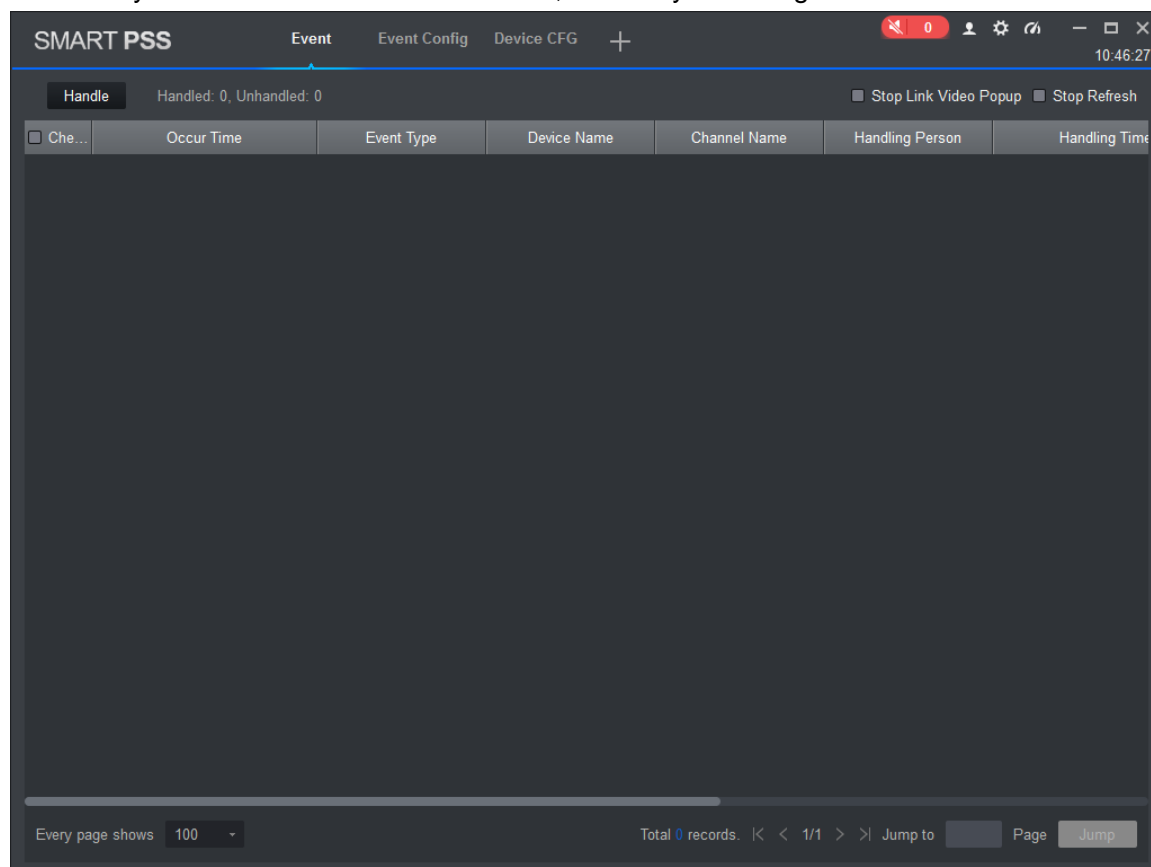

Figure 11-6

12. Video Wall

12.1 Video Wall

User may set video wall layout, live preview on wall, scheme and tour plus playback on wall.

In New tab, click Video Wall, see Figure 12-1.

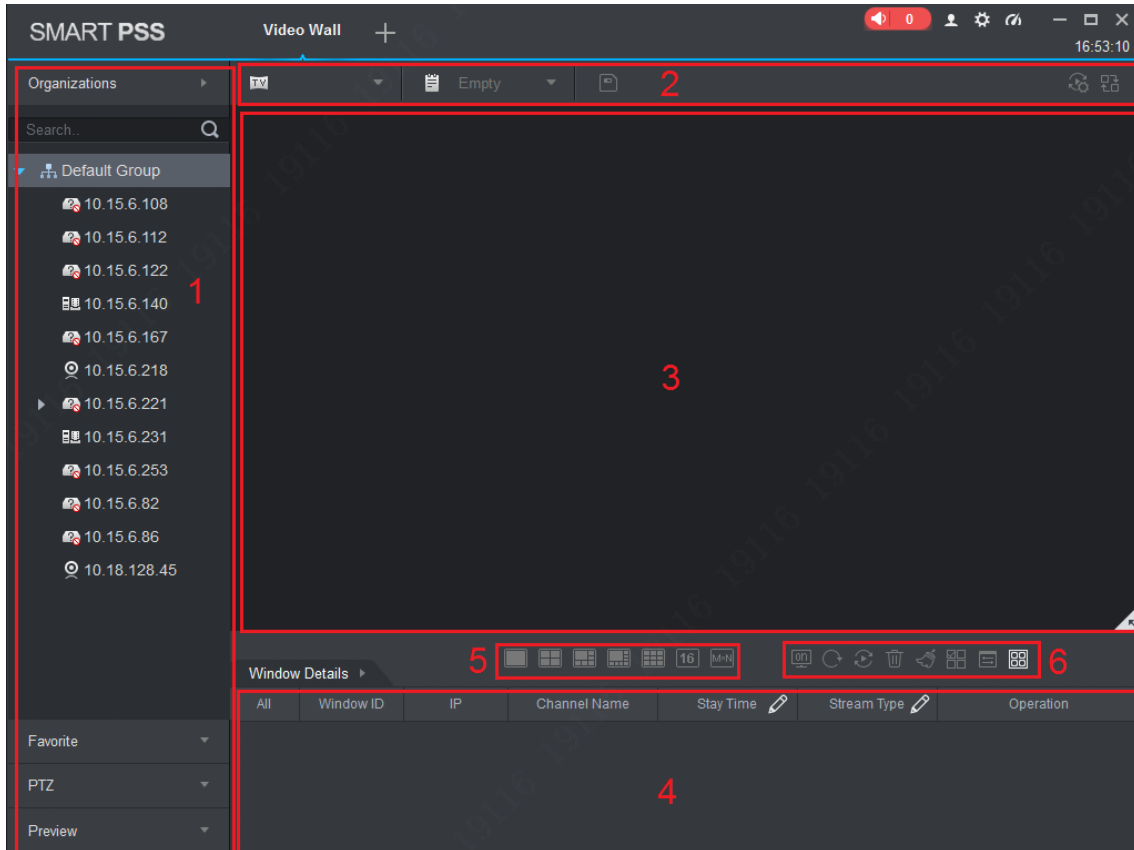

















Figure 12-1

| Serial number | Task | Note |
|---------------|---------------|--|
| 1 | Device list | <ul style="list-style-type: none"> When set Default Device Tree to Device Tree (by device), the device tree displays device group and channels for the device. When set Default Device Tree to Area Tree (by channel), the device tree displays device channels. <p>See Ch 8.</p> |
| | Preview | <ul style="list-style-type: none"> Right click device channel and select Preview, display corresponding device channel in the Preview area. Select window of video wall with bound device channel, in Window Details area>Operation column, click , corresponding video will be displayed in the video preview area. |
| | Switch stream | <p>User may switch stream through the following two ways.</p> <ul style="list-style-type: none"> Right click device channel and select stream type, and set the desired stream. |

| | | |
|---|-----------------------|---|
| | | <ul style="list-style-type: none"> Select window with bound device channel, right click to select stream type, and set the desired stream. |
| | PTZ | <p>There are two ways user may enter PTZ control interface.</p> <ul style="list-style-type: none"> Click PTZ area, the system displays the PTZ control interface. Select window with bound device channel, select the right to switch to the head, the system pop-up PTZ control interface. <p>See Ch 4.6.</p> |
| 2 | Video wall | <p>Set video wall layout and channel video preview on the wall.</p> <p>See Ch 12.2.</p> |
| | Scheme tour | <p>Add scheme, set tour and enable tour.</p> <p>See Ch 12.3.</p> |
| 3 | Clear video source | <p>Select window with bound device channel, right click to select Clear Video Source.</p> |
| | Bottom | <p>Select window with bound device channel, right click to select Bottom, to set the video wall to the bottom.</p> |
| | Set wall mode | <p>Select window with bound device channel, right click to select Wall mode>Live or playback on wall, set video wall mode.</p> |
| | Open Audio | <p>Select window with bound device channel, click  at the upper right corner of the screen, to turn on audio.</p> |
| | Paste | <p>Click  the window will occupy the physical screen of the window.</p> |
| | Maximize | <p>Click , the window will fill the window in the whole screen.</p> |
| | Close | <p>Click  to close the window.</p> |
| 4 | Window details | <p>In Window Details area of the window user may view the channel information, set tour video channel time span and stream type, preview video channel, adjust order of video channels or delete unwanted video channel.</p> |
| 5 | Set video wall layout | <p>Click  to switch video wall display layout.</p> |
| 6 | Function bar | <ul style="list-style-type: none"> Click  in the pop-up screen switch box, select screen on or off screen. Click  to refresh the screen information. Choose bound NVR device or device channel video wall in |

| | | |
|--|--|--|
| | | <p>group, click  to open tour; click  to close tout.</p> <ul style="list-style-type: none"> ● Click  to delete the selected window. ● Click  to clear the screen. ● Click , user may select multiple windows, then the icon  changes to ; click a window. ● Click  to display window number and video wall number. |
|--|--|--|

12.2 Config Favorites

You shall place commonly used monitoring or linked channel to a same favorites for easy management and output. In device list, click Favorite tab, see Figure 12-2.

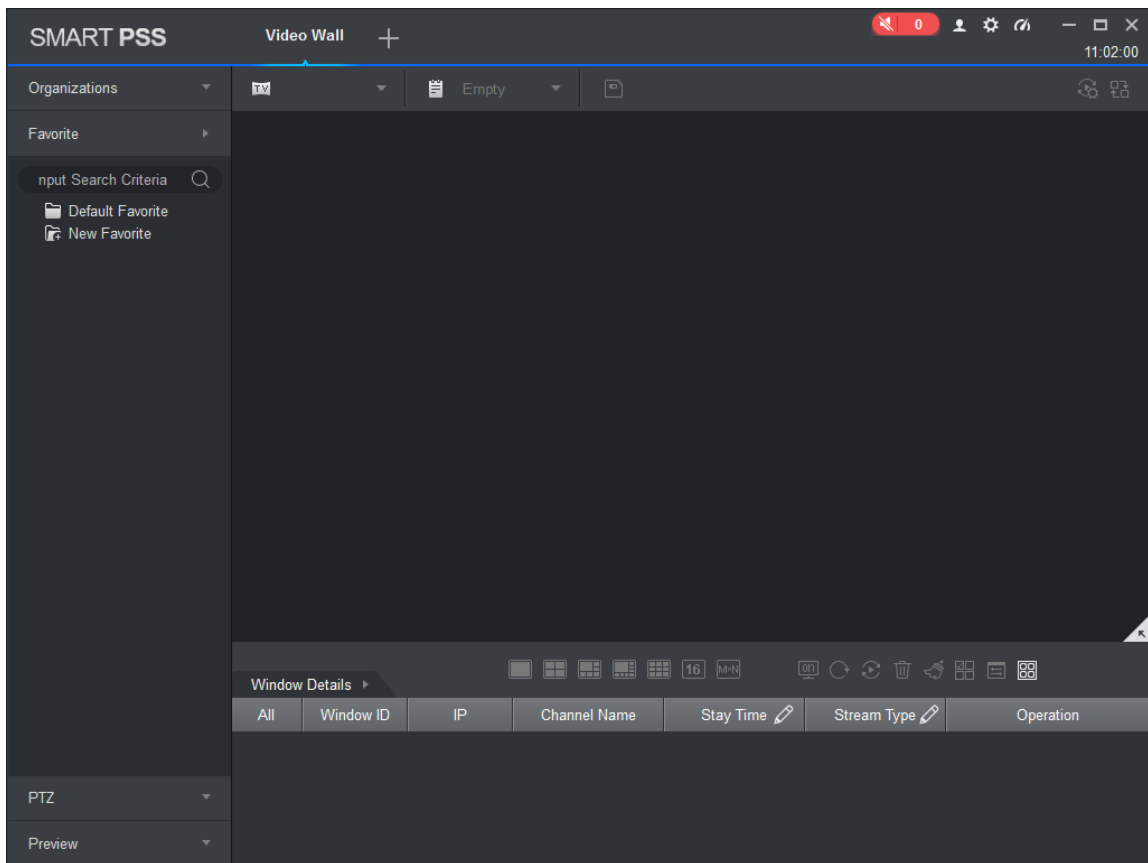

Figure 12-2

12.2.1 Add Favorite

Step 1. In Video Wall interface, right click on favorite list and select Manage Favorite, see Figure 12-3.

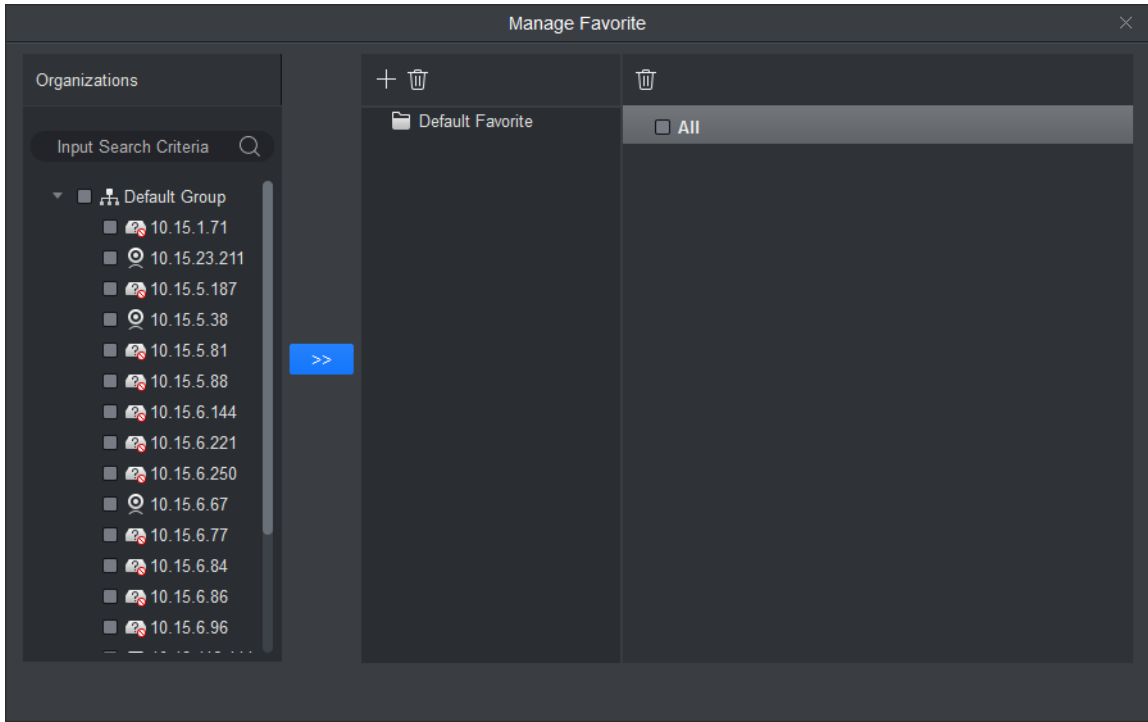

Figure 12-3

Step 2. Click . See

Note:

In Figure 12-2, user may click New Favorite, to open Figure 12-4.

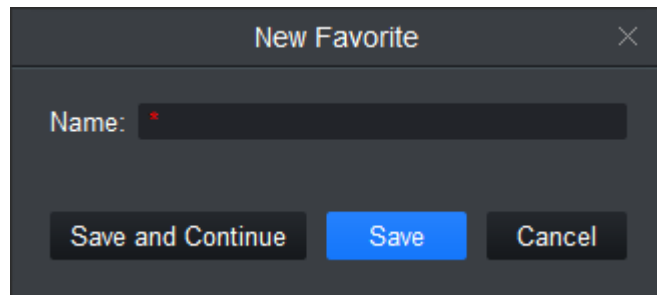

Figure 12-4

Step 3. Enter name, click Save.

Note:

If you want to add more favorites, click Save and Continue to continue adding.

Step 4. Add channel to favorite, see Figure 12-5.

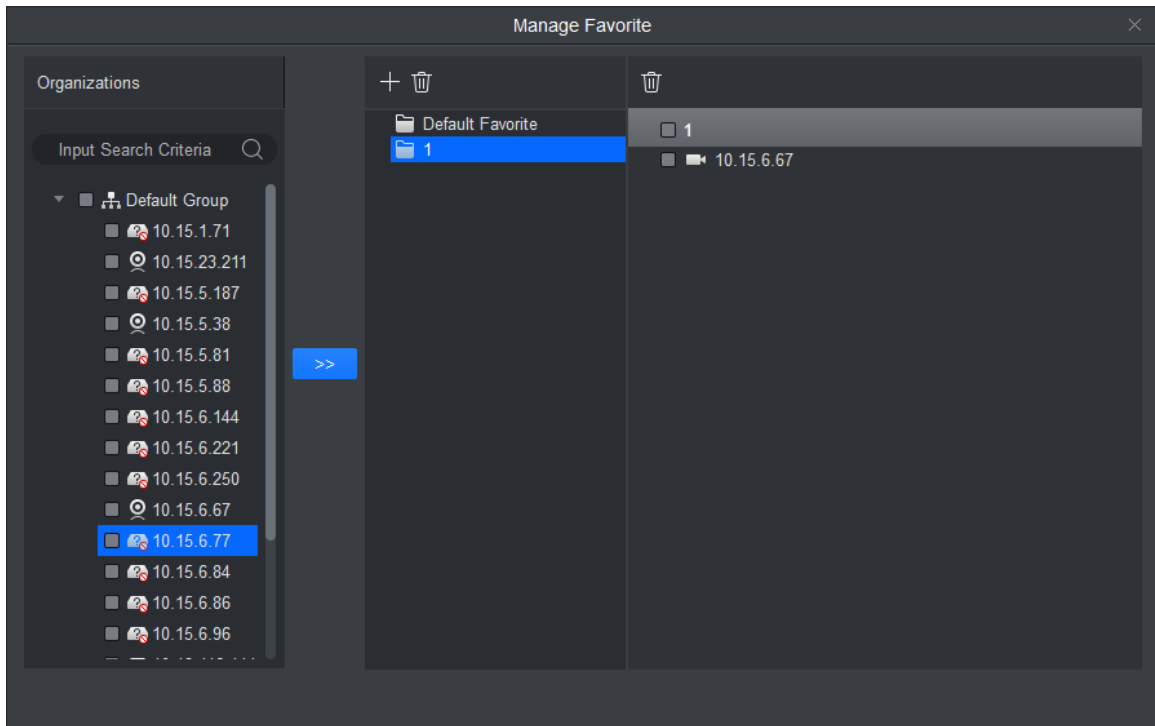



Figure 12-5

1. Select channel on organization tree.
2. Select favorite in favorite list.
3. Click  to complete adding.

Step 5. Click  of Manage Favorite interface to exit.

12.2.2 Delete Favorite

Step 1. In Video Wall interface, right click in Favorite area, and select Manage Favorite.

See Figure 12-3.

Step 2. Select favorite, click  next to it and delete.

Note:

In Figure 12-2, user may click favorite you want to delete, and right click it.

12.2.3 Delete Channel

Step 1. In Video Wall interface, right click in Favorite area, see Figure 12-3.

Step 2. Select favorite to delete.

Step 3. Select channel, click  to delete channel.

Note:

In Figure 12-2, user may click  of channel you want to delete, and select channel, right click delete this item. Confirm your selection.

12.2.4 Change Favorite Name

In Figure 12-2, click favorite name you want to modify, right click Change Favorite Name, enter new name.

Note:

User maynot change name of default favorite.

12.3 Set Video Wall and Output

Condition



- Decoder and video wall are connected successfully.
- Add encoder, see Ch 3.

Step

Step 1. Set video wall layout.

- a) In video wall interface, click  and in pop-up box click +. See Figure 12-6.

Note:

Select multiple screens, click  to add splicing screen; select splicing screens, click  to cancel splicing screen; click  to clear screen config.

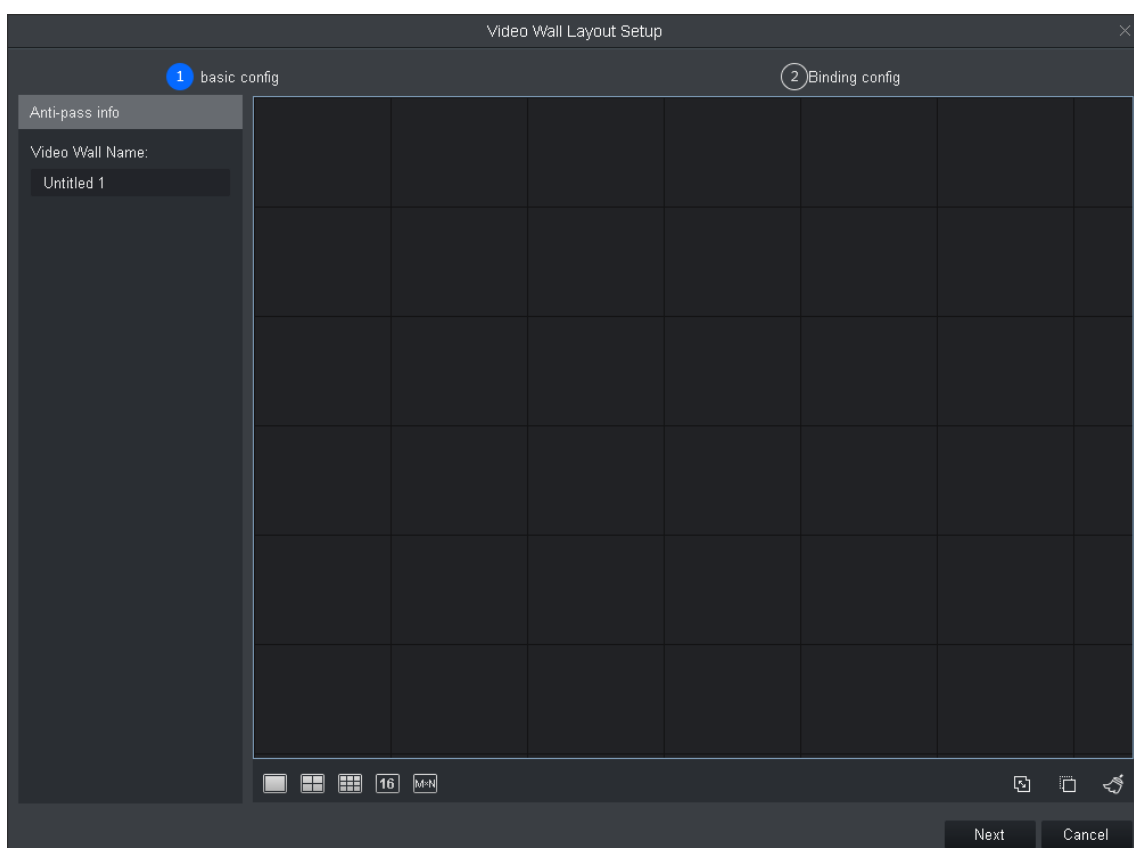

Figure 12-6

- b) In basic config interface, set video wall name, select Layout, and click in video wall, to add video wall layout.
- c) Click Next. See Figure 12-7.



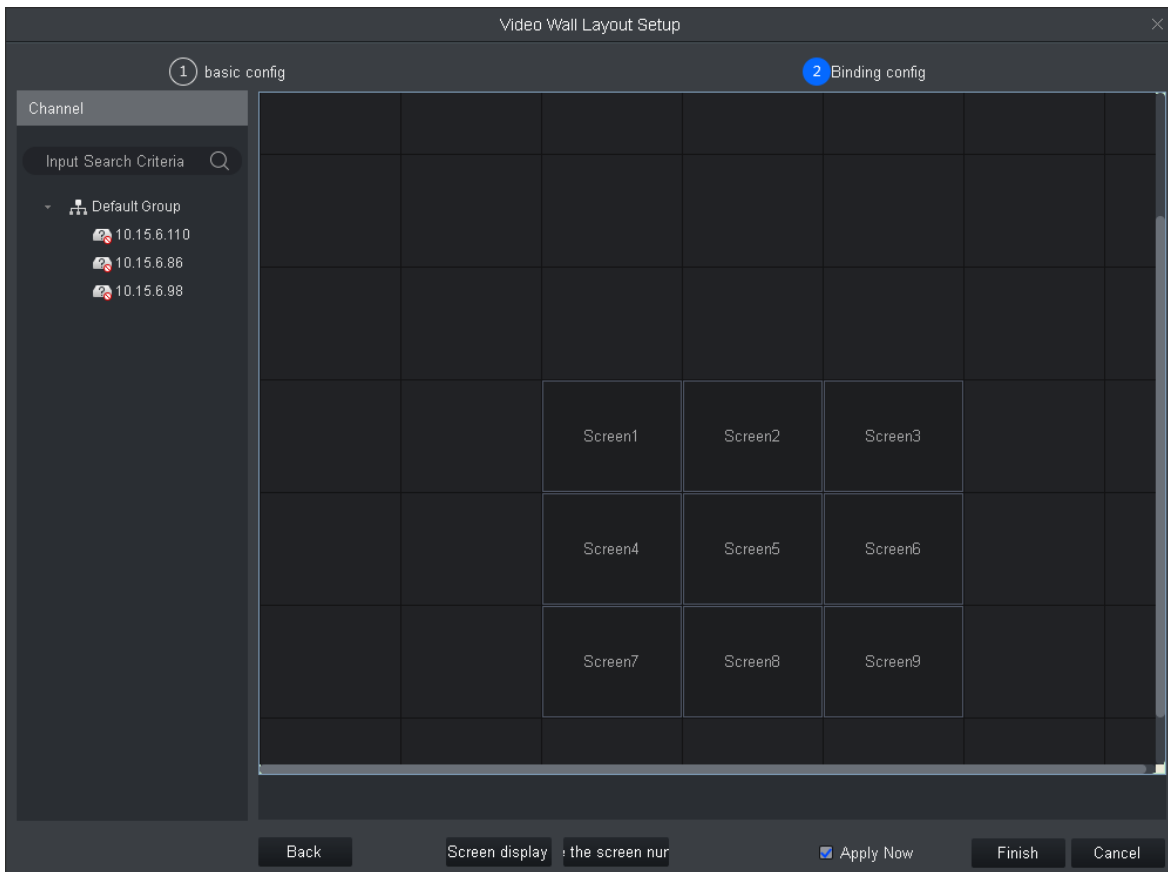

Figure 12-7

d) Drag decoder into slot, to bind decoder and screen.

Note:

- Click screen display, to show screen no., click Hide number to hide screen number.
- If you want to cancel bound decoder slot, right click corresponding screen and select Cancel.

e) Check Apply Now to immediately use this config; click Finish to complete setup.

Note:



Check Apply Now, then return to video wall interface to enable this config.

Step 2. Preview channel video on wall.

a) In Video Wall interface, click layout you want, and slide , to enable video wall layout.

See Figure 12-8.

Note:

In pop up box, select video wall layout, click  to modify video wall layout, click  to delete layout. See Figure 12-8.

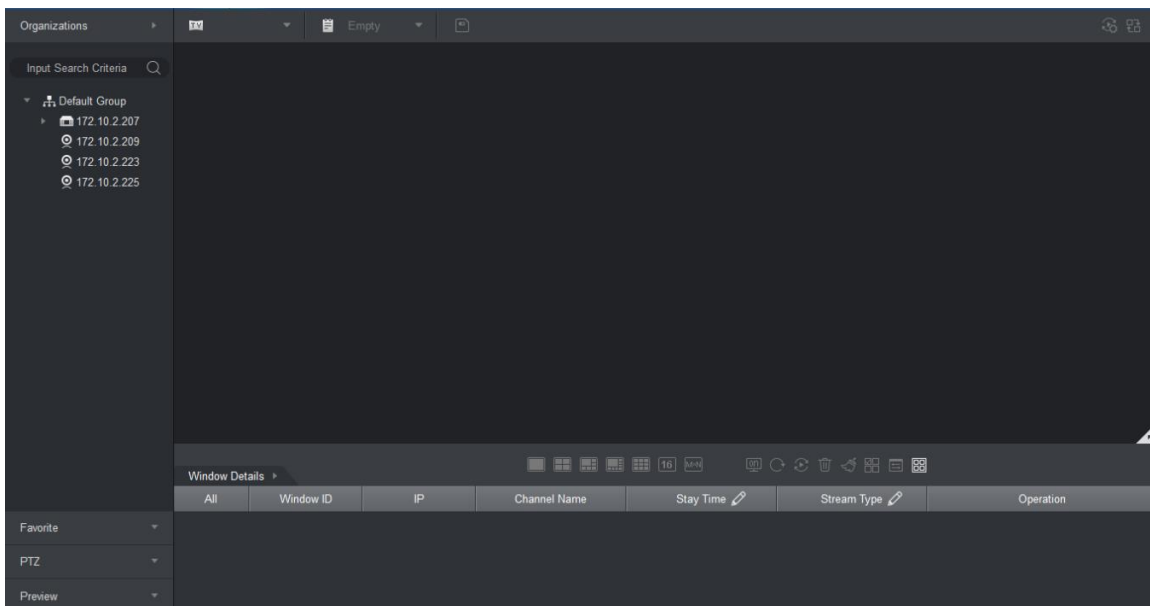

Figure 12-8

- b) Drag device channel into screen, bind channel and screen. Video of corresponding channel is played in the screen, and channel info will be show in Window Details area.

Note:

- Via window split, user may enable window in screen.
- When the device supports roaming, user may drag window randomly among all screens.
- When you drag NVR to the screen, then all channels of NVR are toured on video wall. User may view tour window channel info in Window Details area. User may set tour channel time span and stream type and preview channel video in Operation column, adjust channel order or delete channel.

12.4 Scheme Tour on Video Wall

Step 1. Add plan.

- a) Select video wall layout and bind channel.
- b) Click . See Figure 12-9.

The 'Add Plan' dialog box is a simple window with a dark background. The title bar at the top says 'Add Plan' and has a close button (X) on the right. Below the title bar, there is a text input field with the label 'Plan Name:'. At the bottom of the dialog, there are two buttons: 'Save' and 'Cancel'.

Figure 12-9

- c) Set plan name, click Save.
Repeat step a to c to add more plans.

Step 2. Set scheme tour.

- a) Click . See Figure 12-10.

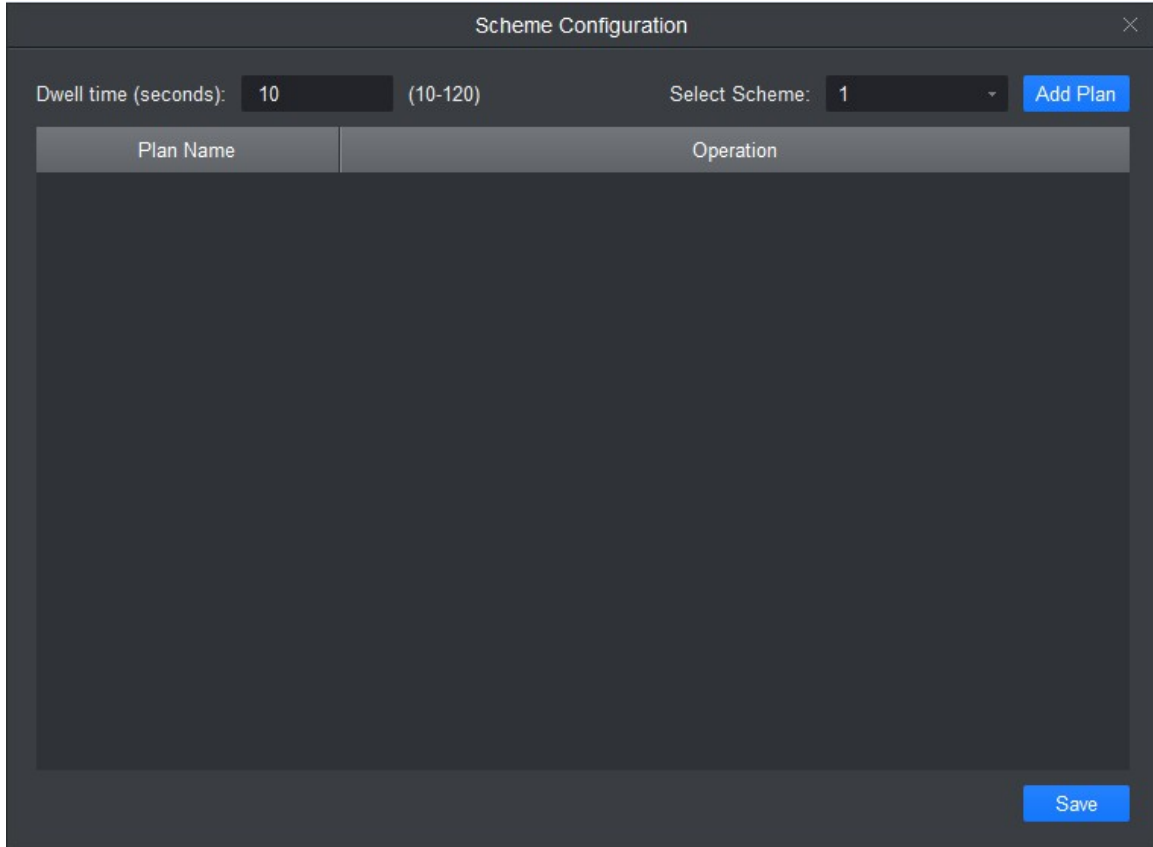



Figure 12-10

- b) Set time span and select scheme, click Add Scheme. Repeat this step to add more schemes.
Note:
User may adjust scheme order and delete scheme in Operation column.
- c) Click Save.

Step 3. Click  to enable scheme tour.

Click , to disable scheme tour.

12.5 Playback on Video Wall

Playback device channel record on video wall.

Condition

- Complete video wall config.
- Record exists in device channel.

Steps

Step 1. Select screen with bound device channel, right click Video Wall>Playback on Video Wall.
See Figure 12-11.

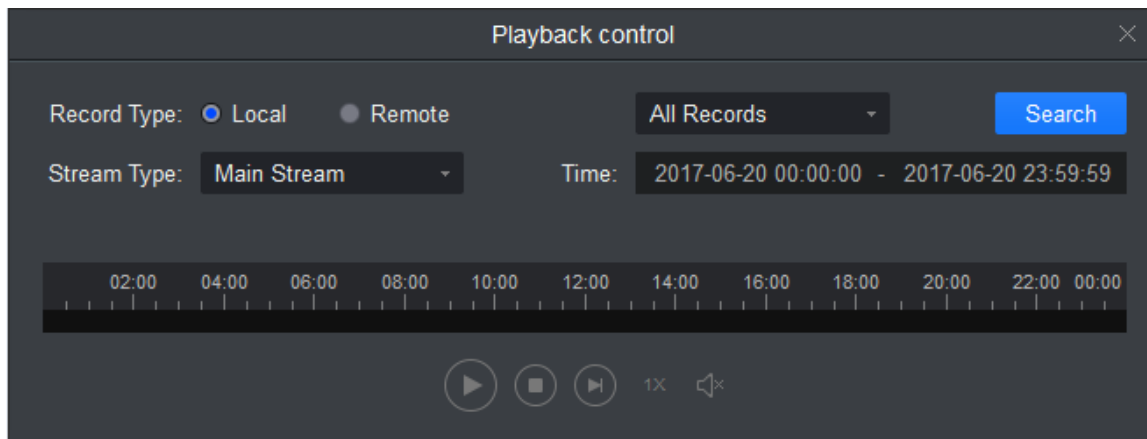

Figure 12-11

Step 2. Select record type and stream type, and set time.

Step 3. Click Search.

Step 4. Select record file, click  to playback record.

13. People Count

User may search and export people count result, contrast by time and channel and export people count data.

Condition

- Enabled people count function, see Ch 4.4.4.
- People count data exist in device.

Steps

Step 1. In New tab, click People Count. See Figure 13-1.

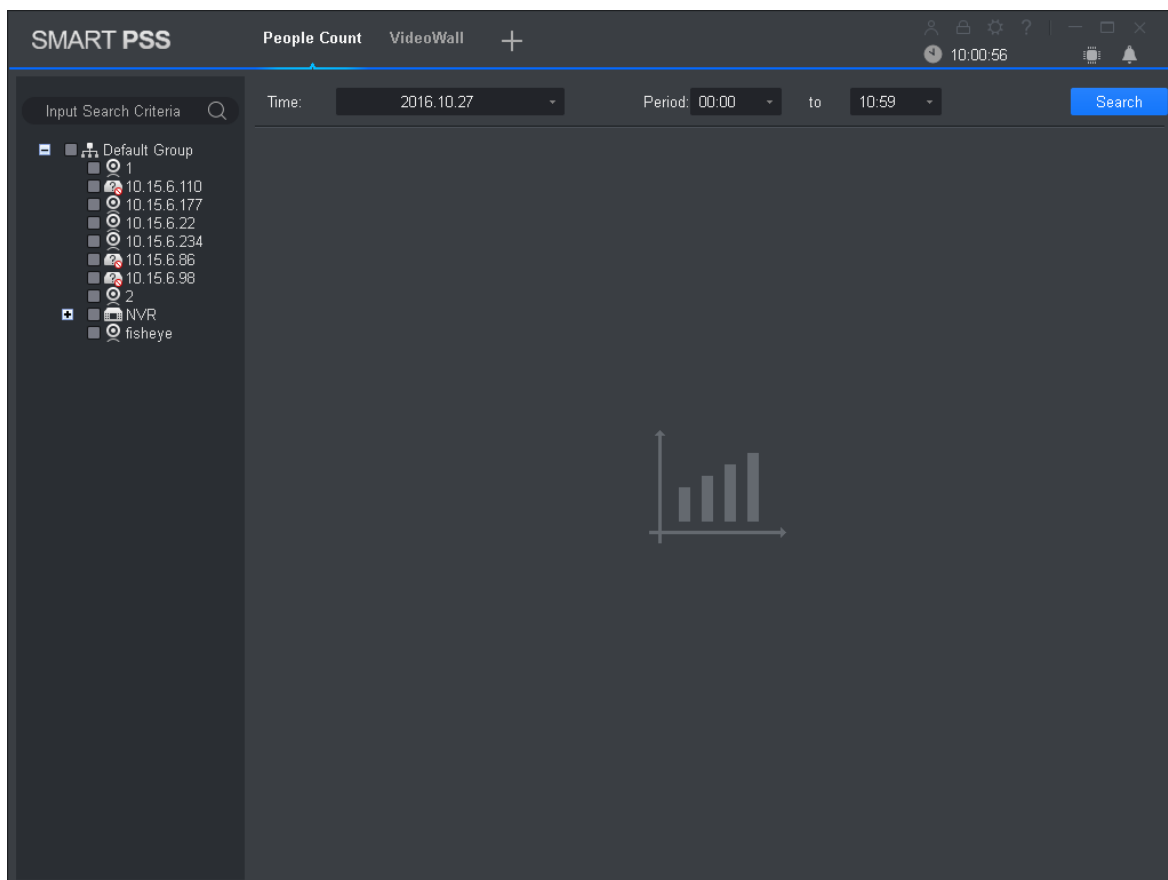

Figure 13-1

Step 2. Select channel with people count data, and set time and period for search.

Note:

- User may search people count data by date, time, year or month.
- If you select multiple channel, then it will search data of these channels in search period

Step 3. Click Search.

The system shows people count result in this period, see Figure 13-2.

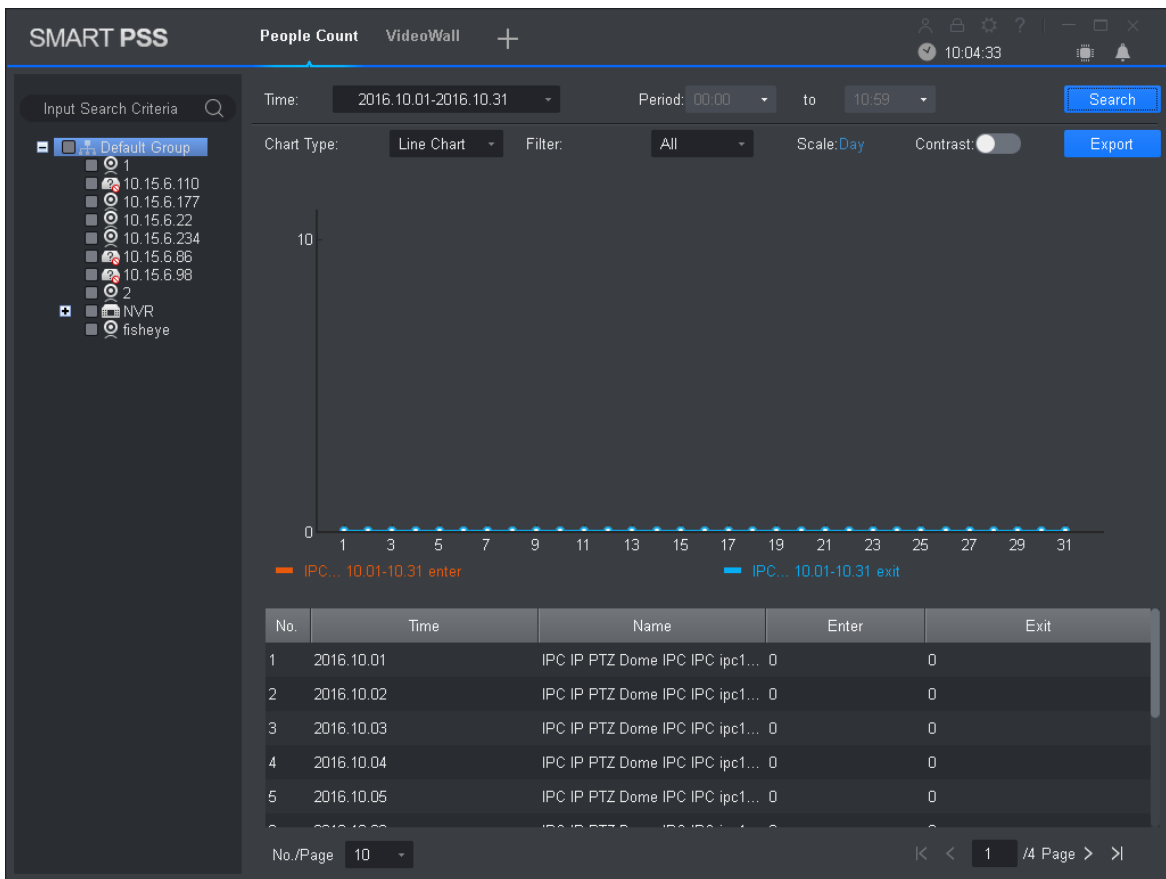



Figure 13-2

Step 4. Contrast people count results.

- a) Select statistical figure type, set filter to be ex Enter or Exit, and click  to enable contrast.

See Figure 13-3.

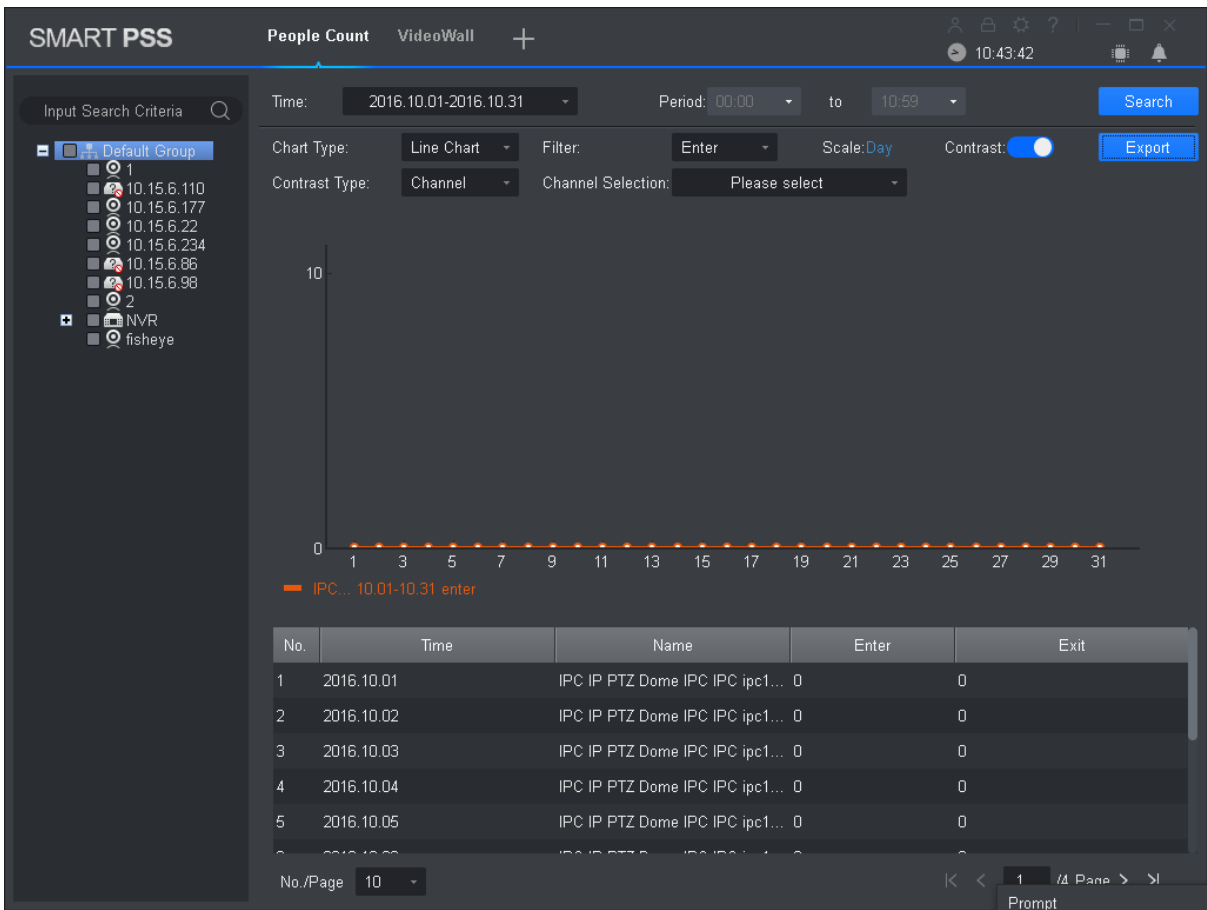

Figure 13-3

- b) Set contrast type to Channel and select channel for contrast. This contrasts people count results of different channels within the same period. Set contrast type to Time and select time for contrast. This contrasts people count results of different periods for the same channel. System shows result.

14. Heat Map

User may search object moving accumulated density in device monitor image.

Condition

- Device has enabled heat map statistics.
- Heat map data exist in device.

Steps

Step 1. In New tab, click Heat Map. See Figure 14-1.

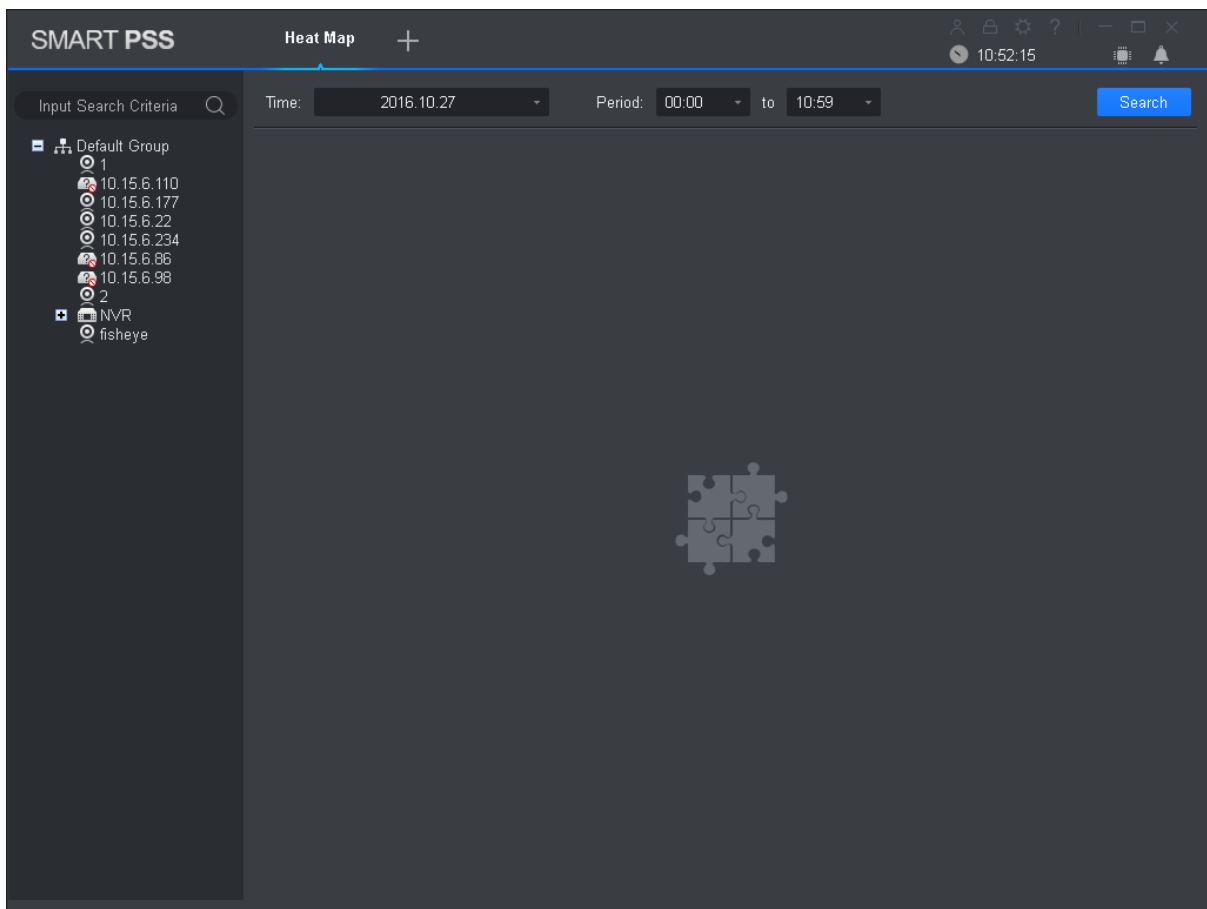

Figure 14-1

Step 2. Select camera with existing heat map data, and set search time and period.

Note:

User may search heat map data by date, period, or day of week.

Step 3. Click Search. System shows object moving accumulated density result of this period monitored by device.

Click Export to export heat map data.

15. PC-NVR

After PC-NVR is added, user may manage disk, manage channel, set record plan and view version.

Condition

- PC-NVR is installed and running now.
- See Ch 3 to add PV-NVR.

15.1 Disk Manager

Step 1. In New tab, click PC-NVR.

Step 2. Select HDD tab, see Figure 15-1.

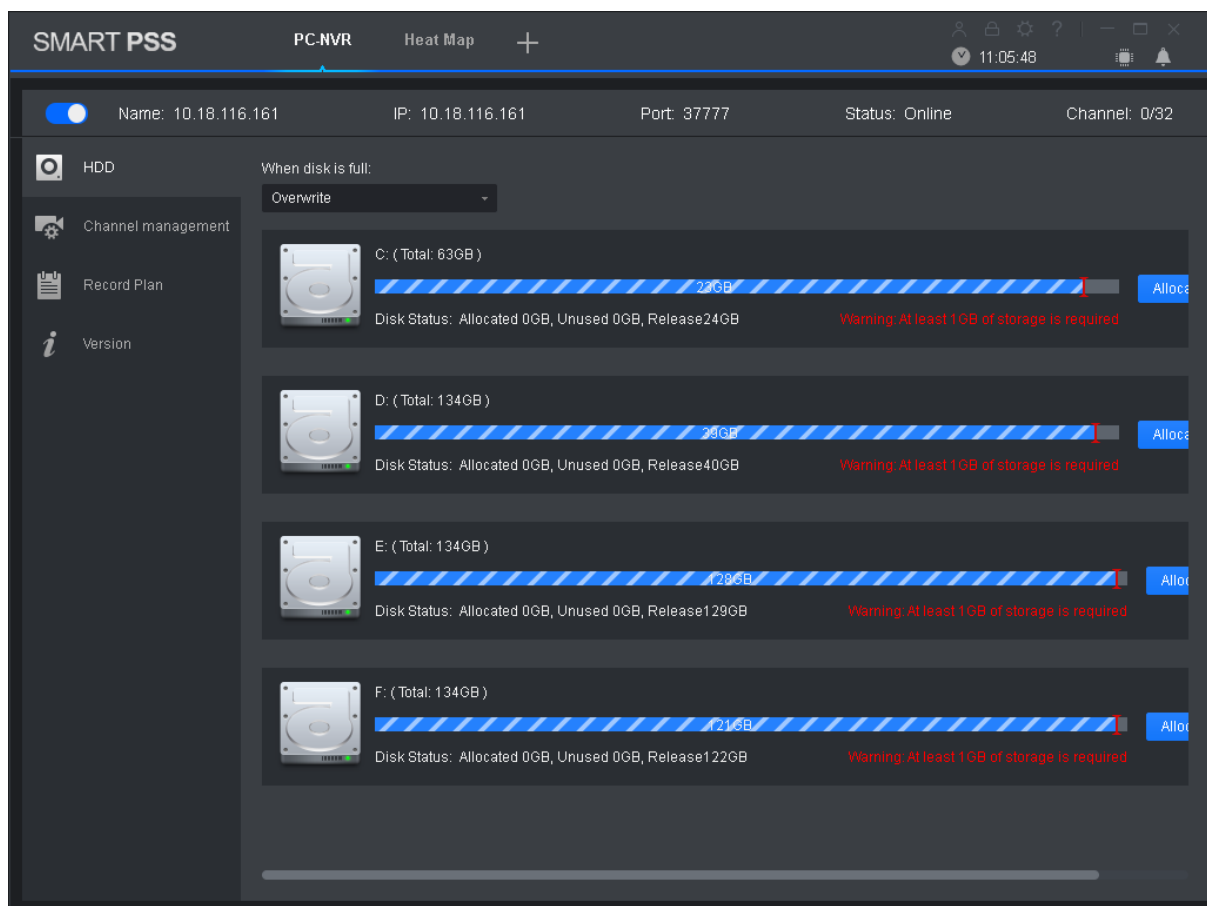

Figure 15-1

Step 3. Select record plan when HDD is full, and set disk space, click Allocate.

System pops up info box, click OK.

Warning:

Re-allocate disk space, system will delete all record files on the disk, be careful!

15.2 Channel Management

Set channel info to pass PC-NVR record plan.

Step 1. In New tab, click PC-NVR.

Step 2. Select Channel Management tab, see Figure 15-2.

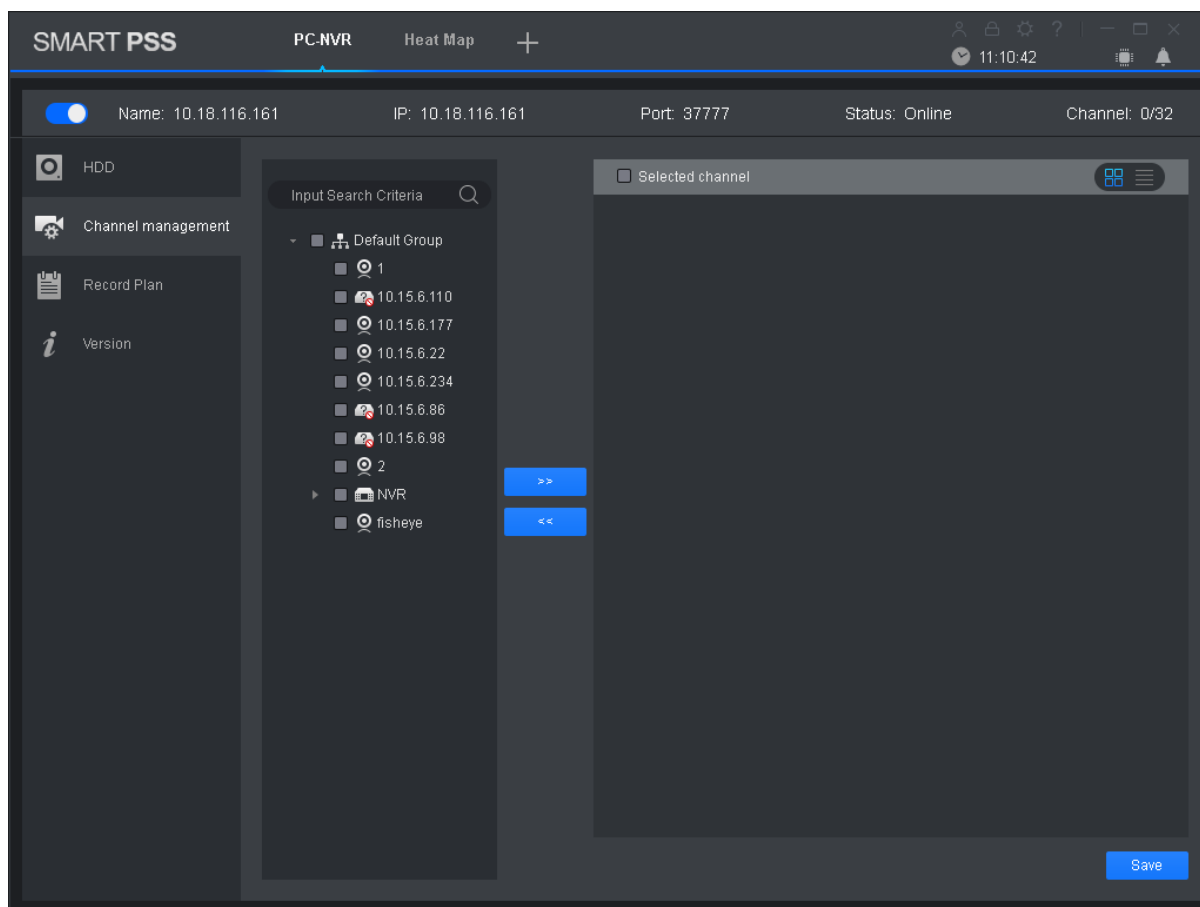





Figure 15-2

Step 3. In device list select device channel, click . System will add the selected device channel to list on the right.

Note:

- Click  to add device channel and shown in thumbnail, click  to add device channel and shown in list.
- If you delete unwanted device channel, check box in front of one device channel or check Selected channel to select all channels, click  to delete.

Step 4. Click Save.

15.3 Set Record Plan

For the selected channel, set record schedule, motion detect, alarm, MD& alarm, or smart record plan.

Step 1. In New tab, click PC-NVR.

Step 2. Select Record Plan tab. See Figure 15-3.

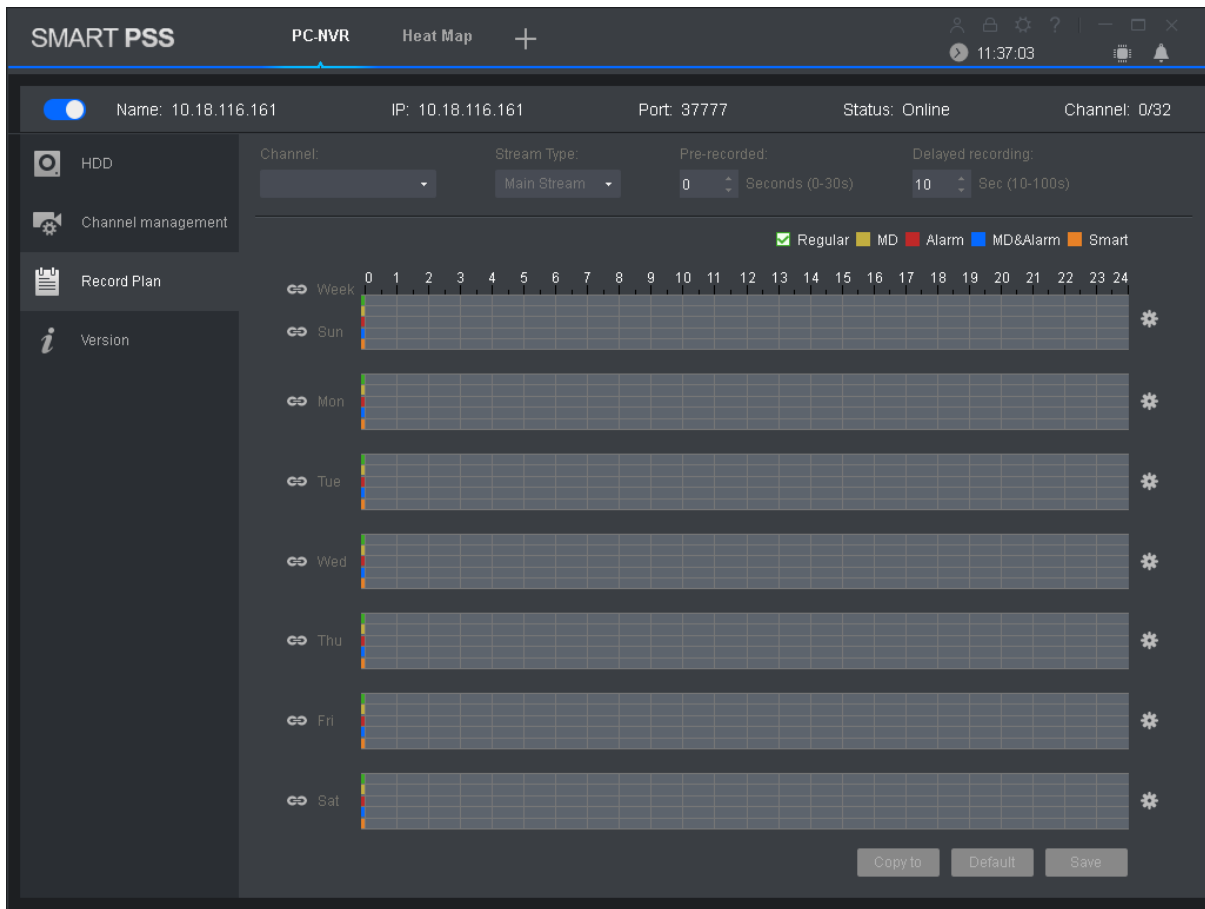



Figure 15-3

Step 3. Select channel to set record plan, select stream type, set pre-record time and delay record time.

Step 4. Check record type, and select record time in corresponding day of week bar.

Note:

User may click  next to each day of week bar, and in pop-up box set record type and period.

Step 5. Click Save.

Note:

- Click Copy to, and check device channel, user may copy the record plan in this channel to other device channel.
- Click Default to restore default status of device channel record plan.

15.4 Version Info

User may view PC-NVR name, storage path and version.

Step 1. In New tab, click PC-NVR.

Step 2. Select Version tab, see Figure 15-4.

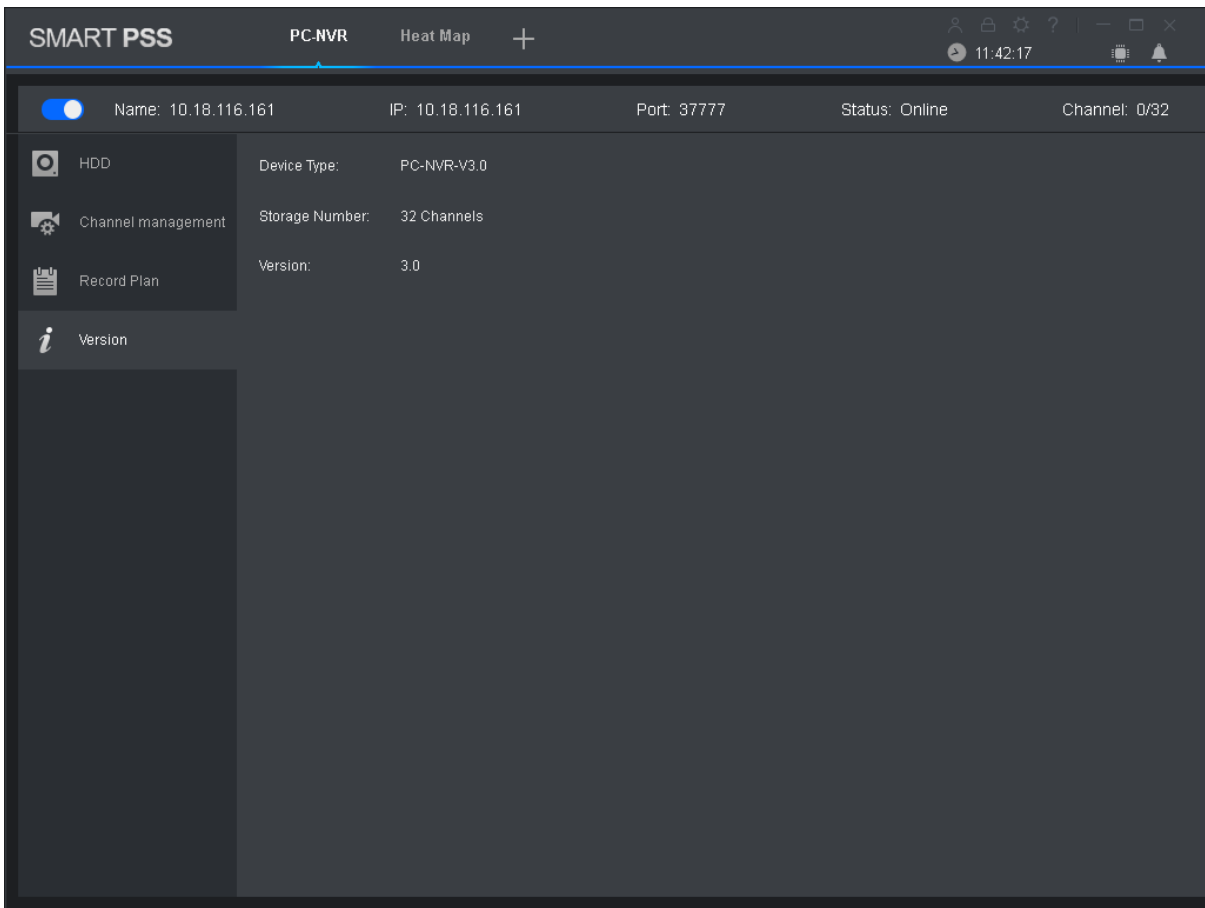



Figure 15-4

15.5 Modify Port

Step 1. Click  at the lower-right corner of PC, select PC-NVR Setting. See Figure 15-5.

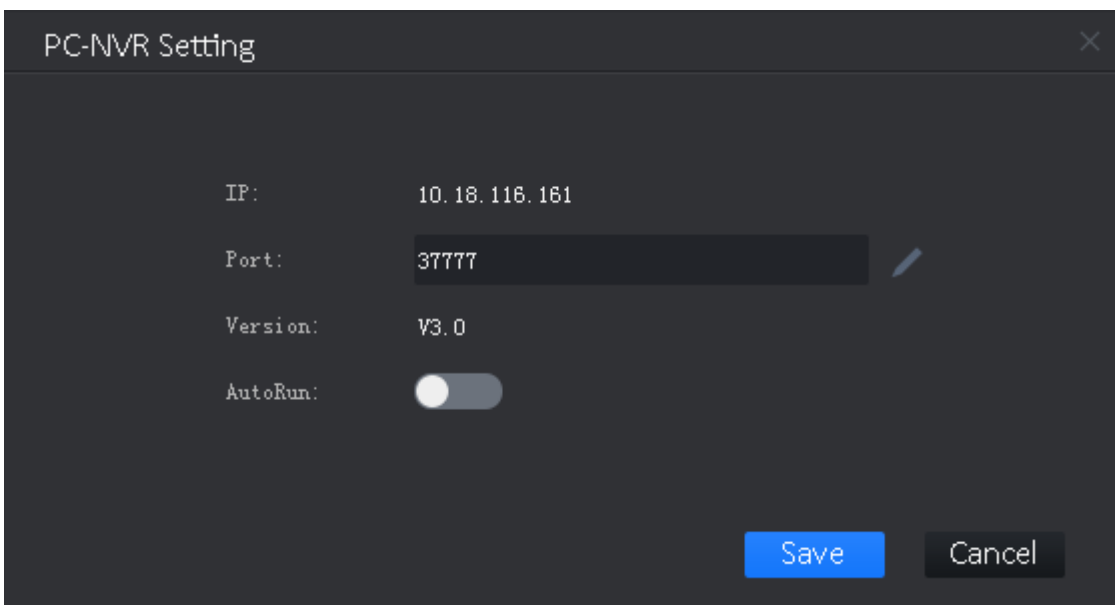



Figure 15-5

Step 2. Click  and enter port no. you want.

If you slide  to enable auto ON, after PC boots up, PC-NVR will be ON automatically.

Step 3. Click Save.

15.6 Modify Password

Step 1. Click  at the lower-right corner of PC, select Password Setting. See Figure 15-6.

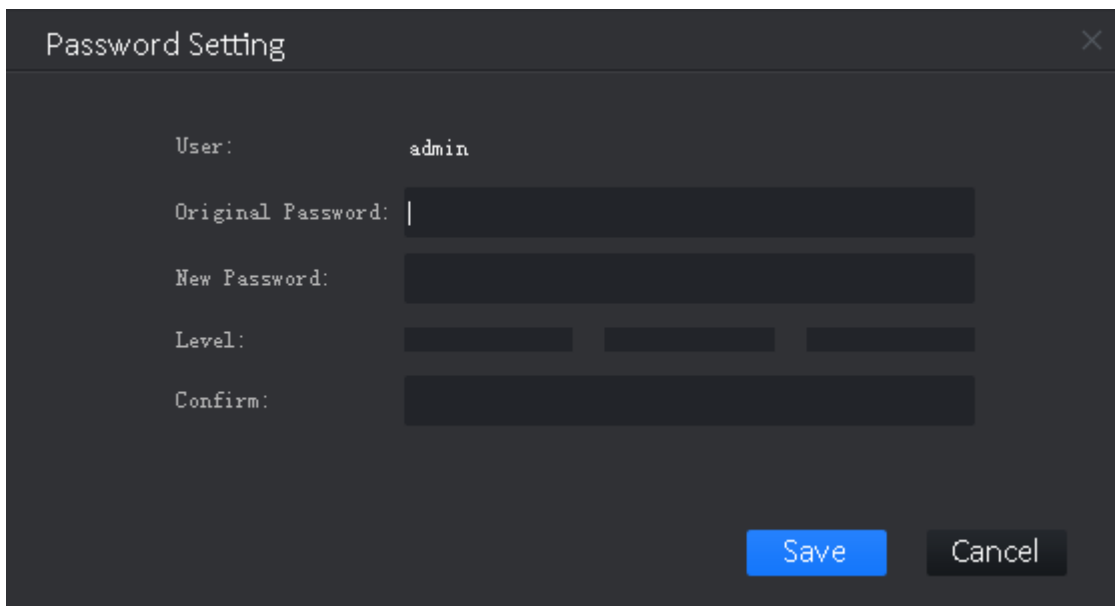

The screenshot shows a 'Password Setting' dialog box with the following fields and controls:

- User: admin
- Original Password: [text input field]
- New Password: [text input field]
- Level: [radio button] [radio button] [radio button]
- Confirm: [text input field]
- Buttons: Save, Cancel

Figure 15-6

Step 2. Enter original password, and enter new password, confirm new password.

Step 3. Click Save.

16. Video Talk

SmartPSS supports intercom. It can connect to intercom device, for call, live preview, remote unlock, message sending and etc.

The following is just an example.

Note:

- Intercom device must be connected to LAN and configured ready.
- After fence station and VTO web interface are configured, you need to add to SmartPSS Client, please refer to Ch 3.5 for steps to add device.

Click , in New Function interface, select Intercom to show intercom interface.

16.1 VTS Center

Note:

If it is the first time entering intercom interface, you will see a setup interface.

Step 1. Click .

See Figure 16-1.

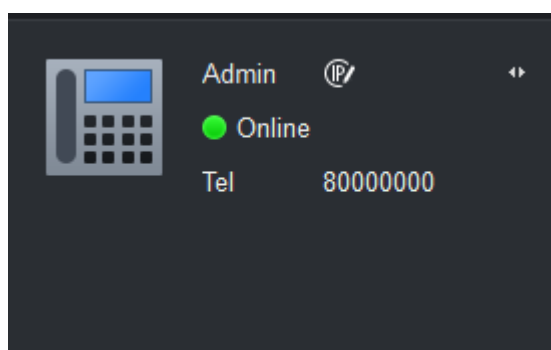

Figure 16-1

Step 2. Click . See Figure 16-2.

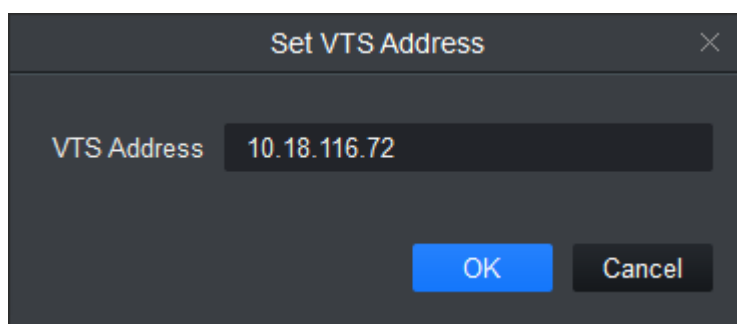

Figure 16-2

Step 3. Enter VTS address, click OK.

16.2 Monitor

Step 1. Click .

Step 2. On device tree, double click device, or drag device to monitoring window, see Figure 16-3.

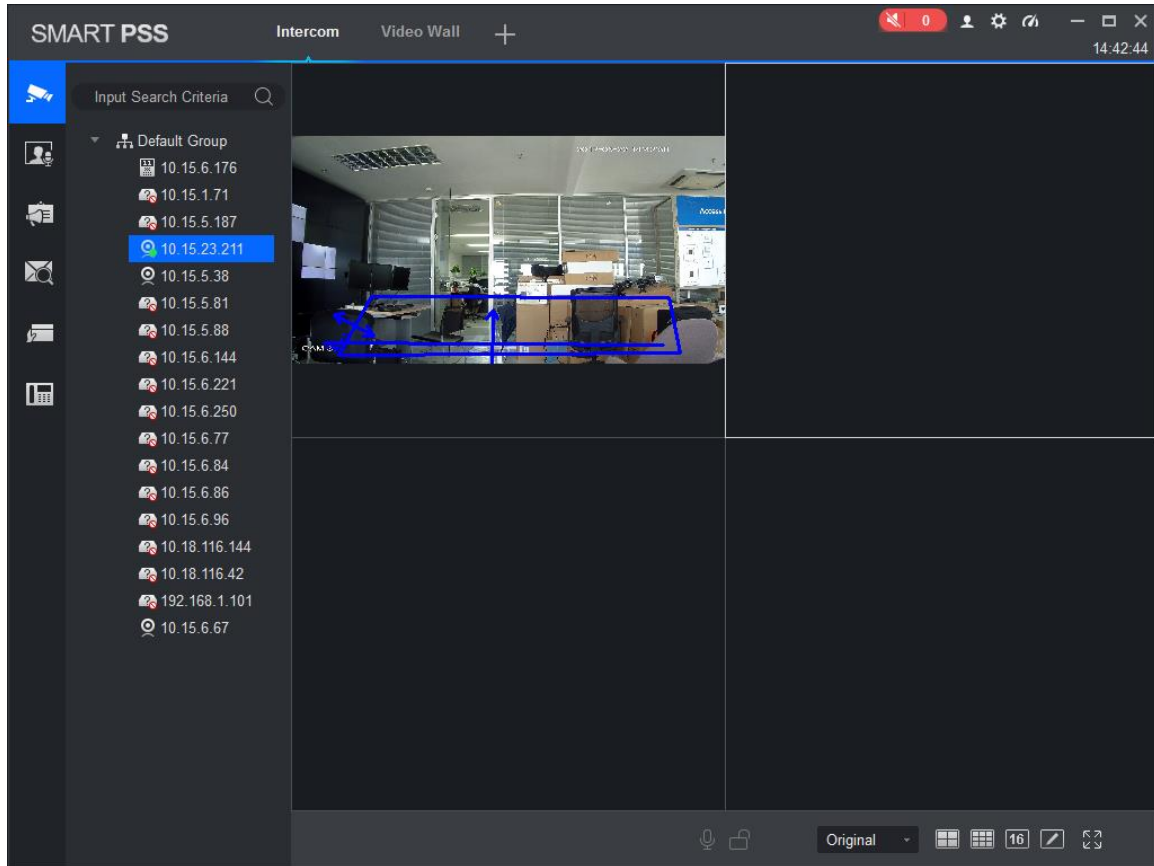









Figure 16-3

Step 3. In Monitor interface, user may unlock , call fence station or VTO.

- Click  in the window, or  at lower bottom, or right click to select  start call.





All of these allow client to VTO or fence station.

- Click  in the window, or  at lower bottom, or right click to select  unlock.

Click ,  in the window, or right click to select snapshot, start record.

User may snapshot or record the live preview.

In video window, right click menu includes snapshot, record, switch string type, adjust window scale and etc.

- Click ,  or right click  Snapshot,  Start Record.

- More function

In video window, user may snapshot, record, change steam and etc. Refer to Ch 4.

16.3 Intercom

Step 1. Click .

Step 2. Click device on device tree, see Figure 16-4.

Note:

According to info reported by fence station, or VTO, it will auto generate contact list.

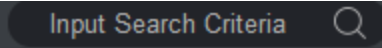
By click  next to Contact, user may quickly search contact. It supports fuzzy search of building, unit, room.

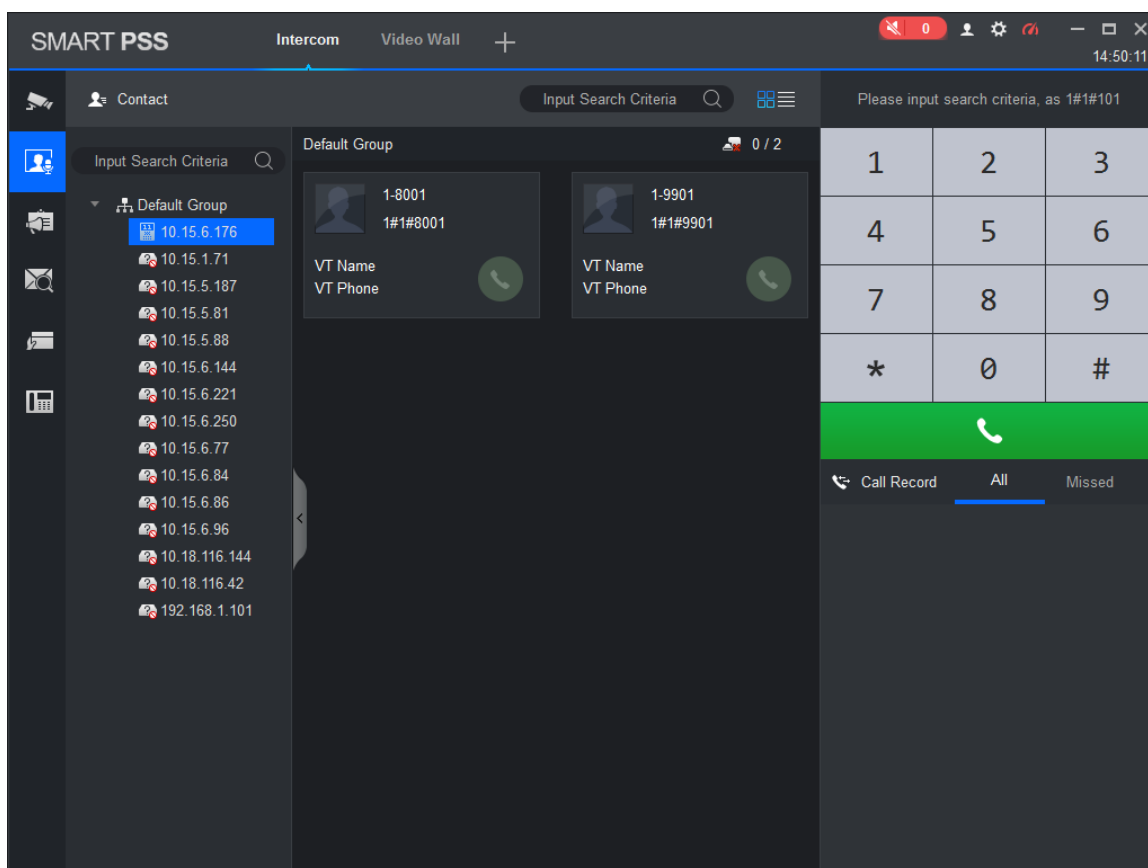

Figure 16-4

Step 3. In Contacts interface, user may call VTO, VTH and etc.

- If client needs to call VTO in a certain unit.

Step 1. Right click  on VTO name card to call VTO.

System pops up call box, see Figure 4-43.

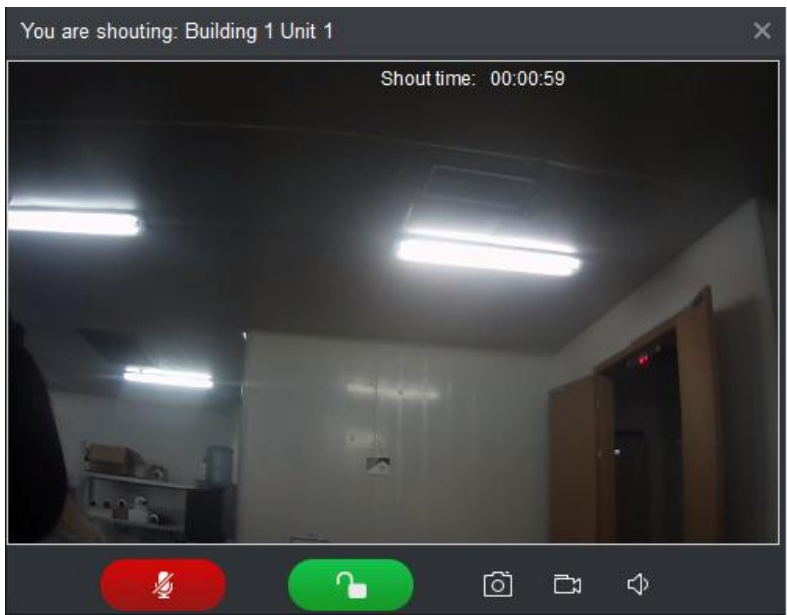



Figure 16-5

Step 2. Click .

Step 3. System pops up dialogue box, click OK.
User may remotely unlock VTO.

Step 4. Click , to stop existing call.
Call window will not close.

- If client needs to call a VTH in a specific room and unit.

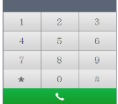
Step 1. Click  on VTH name card or dial number on .

Please note client and VTH can talk to each other as a bidirectional talk.
System pops up calling box and ask you to wait, see Figure 16-6 .

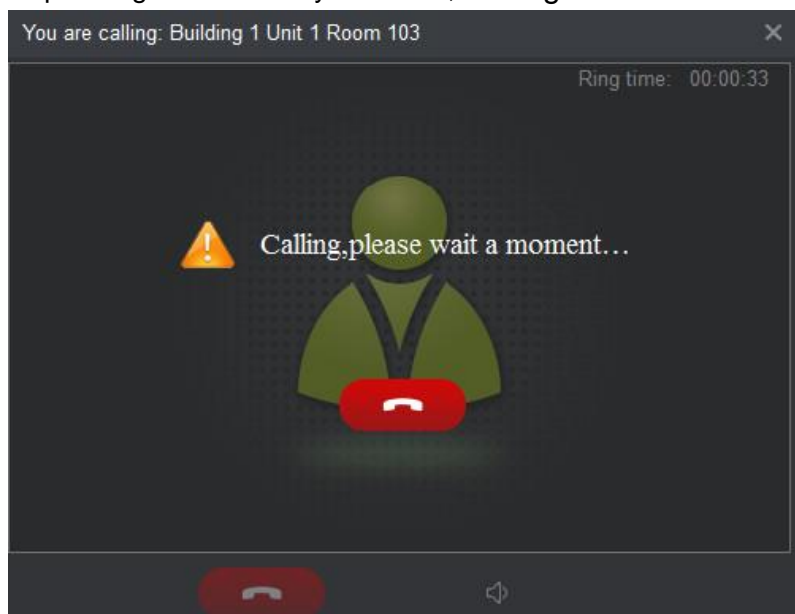

Figure 16-6

Step 2. When VTH picks up, client can talk with VTH.

- If VTH does not answer over 60s, then client pops up a box to ask if you want to dial again.

User may click  to re-dial.

- If the VTH is busy or hang up call, client will ask you to try again later.

- If VTO is calling client.

Client pops up VTO call box, see Figure 16-7.

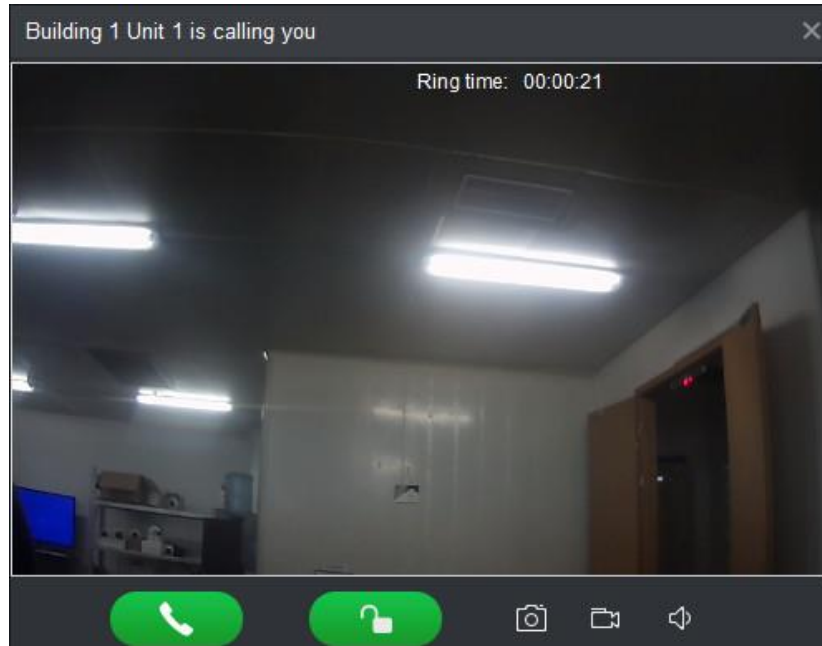



Figure 16-7

User may click  to answer VTO call, and start a bidirectional talk.

User may click  to unlock.

- If VTH is calling client.

Client pops up VTH call box, see Figure 16-8.



Figure 16-8

User may click  to talk with VTH.

If there is missed call, in talk interface, in the lower-right, missed calls are shown here. See Figure 16-9.

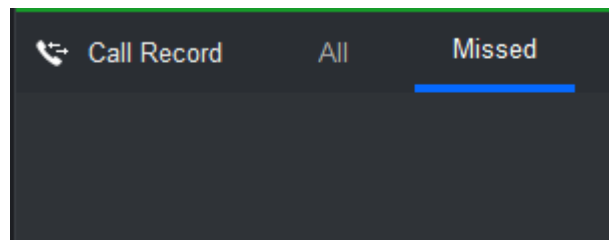

Figure 16-9

16.4 Announcement

Step 1. Click . See Figure 16-10.

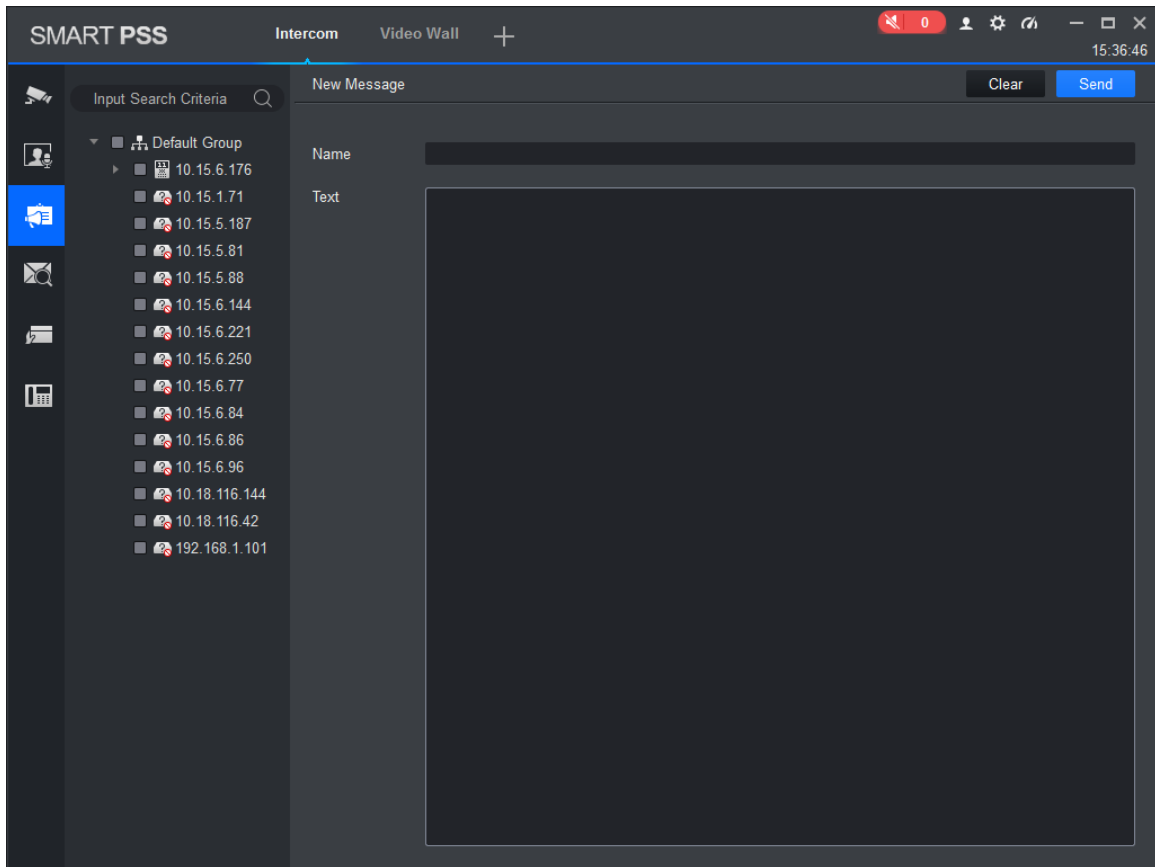

Figure 16-10

Step 2. On device tree, select VTH and support multiple choices.

Step 3. Enter message name and content, click Send. User may view announcement info on VTH.

Note:

During sending, Send button is grey. You shall wait until it resumes before user may send message.

16.5 Search

User may search alarm record, unlock record and call record. This chapter takes alarm record as an example.

Step 1. Click , select alarm record type. See Figure 16-11.

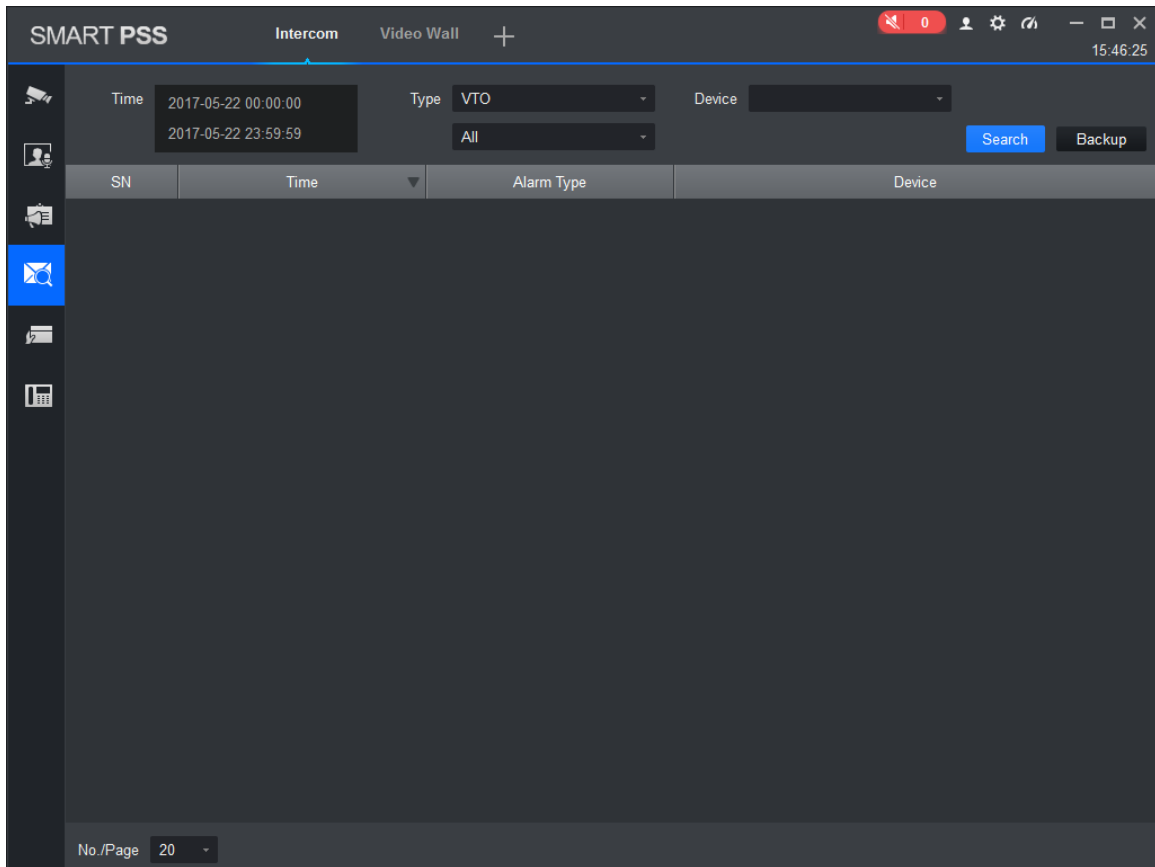



Figure 16-11

Step 2. Set criteria, click Search. User may export result of search.

16.6 Issue Card

Step 1. Click , see Figure 16-12.

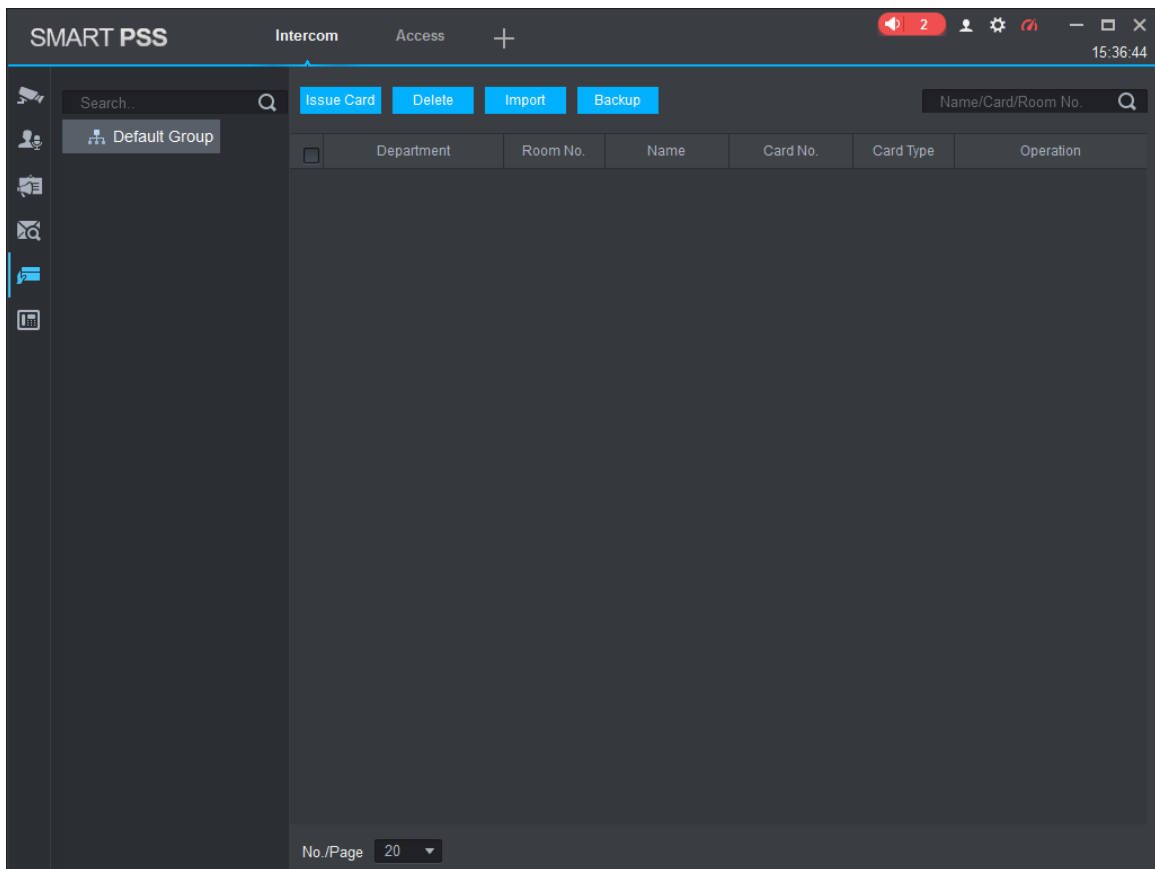

Figure 16-12

Step 2. Create organization tree, see Figure 16-13.

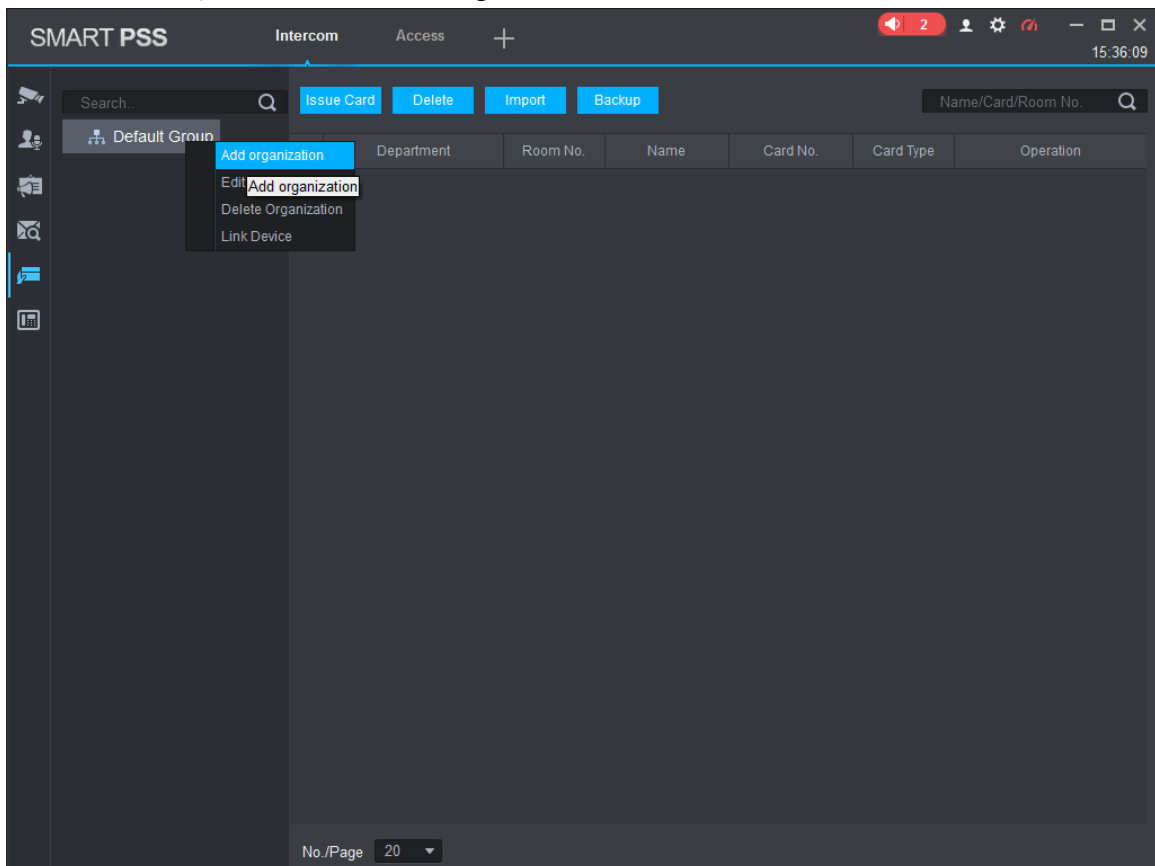

Figure 16-13

1. In blank area of organization tree, right click and select Add Organization. See Figure 16-14.

Note:

You also can click Sync Organization Tree to organization created when you add the device will be shown here.

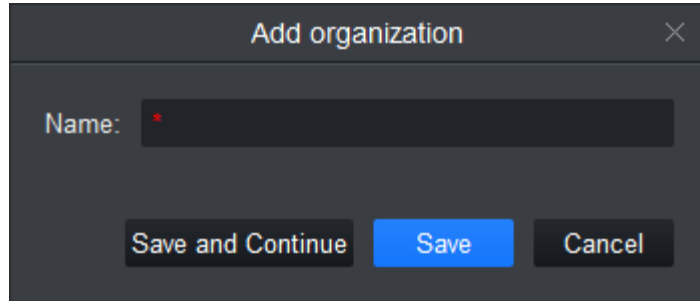

Figure 16-14

2. Enter name.
3. Click the organization you just add, and right click and select Add Organization.
4. Enter name of unit, click Save.
5. Click node of device to link, right click to link device. See Figure 16-15.

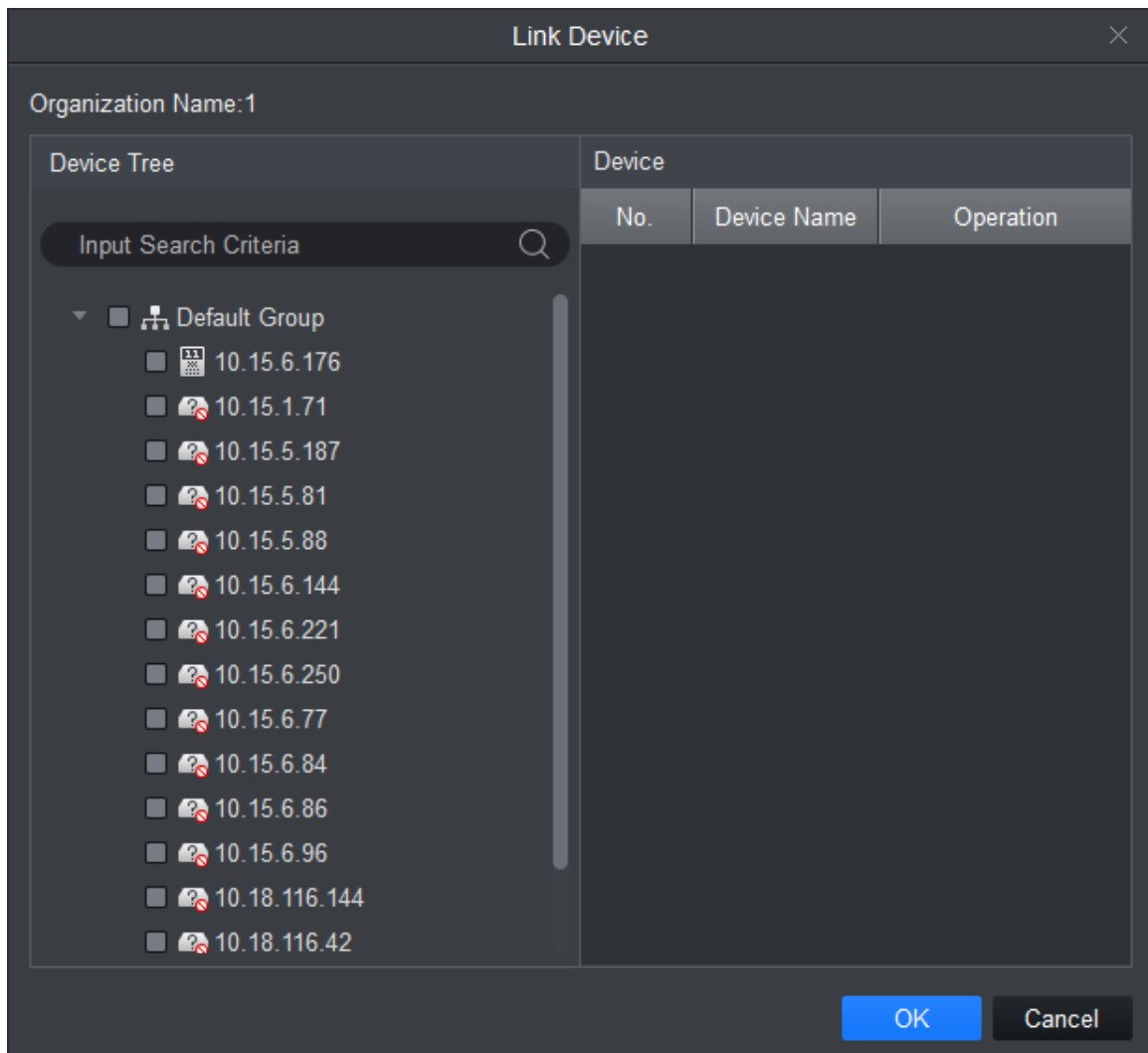

Figure 16-15

6. In device tree select link device, click OK.

Step 3. Issue card.

- Progressively issue card.

Step 1. In device list, click Issue Card, see Figure 16-16.

Figure 16-16

Step 2. Set parameter, click Issue Card, see Chart 16-1.

| Parameter | Note |
|------------------------|---|
| Right Device Selection | Select VTO to issue card. |
| Username | Enter username of cardholder. |
| Card Type | General card and manager card. |
| Room No. | Enter room no. of card. |
| Record Method | When record method is manual, you shall physically enter number. |
| Card No. | When record method is card issuer, you placer card on card reader to get card no. |

Chart 16-1

- Batch Import

Please prepare user info list before you batch issue card, and import user info list to batch. To get user info, user may export user info. You also can back up user info.

Step 1. Click Import.

Step 2. Select user list, click Open.

17. Access

SmartPSS integrates access control device with effective management and configure of device. It achieves modularization of access business and integrates access with video link and e-map. Note:

- Access controller must be added into SmartPSS client, please refer to device adding steps in Ch 3.
- Access controllers are set on SmartPSS, including network, user management, time config and update. See Ch 10.

Click  in New Function interface, select Access.

17.1 Console

Step 1. In Access interface, user may click  See Figure 17-1.

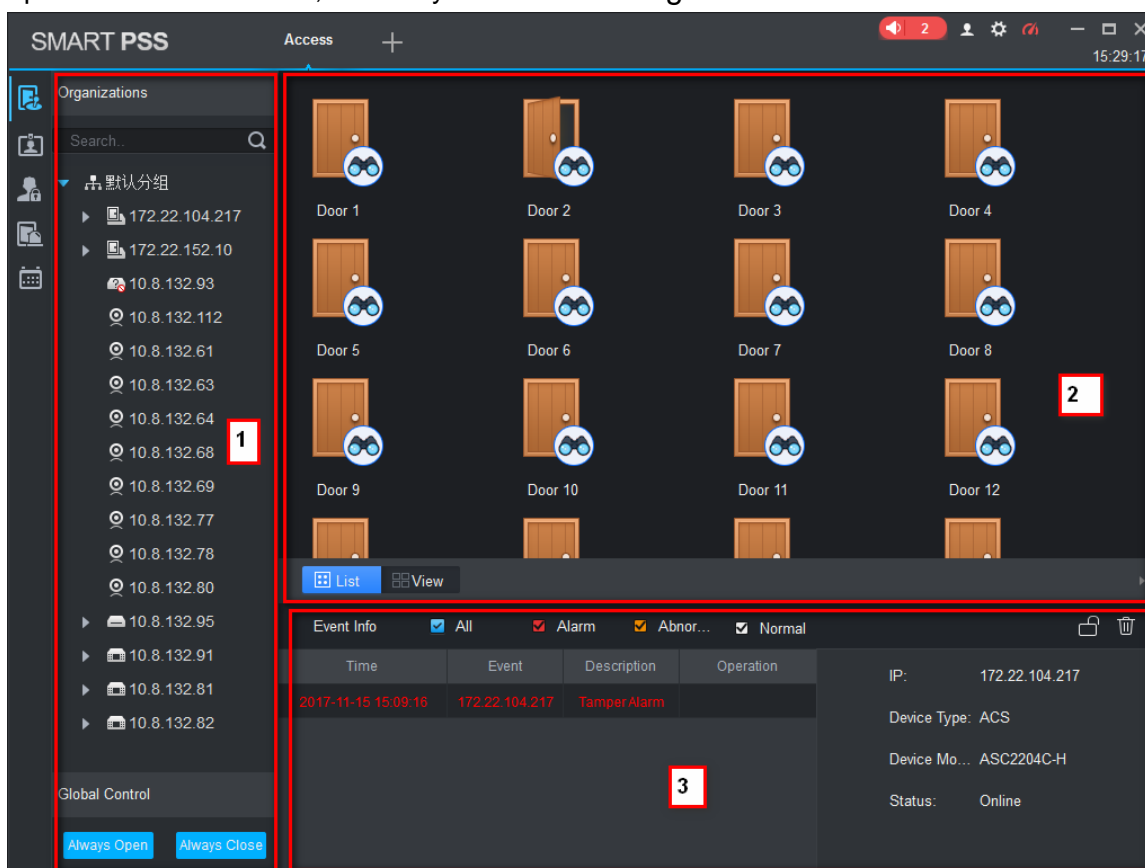

Figure 17-1

| No. | Parameter | Note |
|-----|-------------------------|--|
| 1 | Organizations/ Zones | <p>Include organization tree or zone, right click in blank area to switch.</p> <p>Organization tree has the following operations:</p> <ul style="list-style-type: none"> ● In organization tree blank area, right click to create group (same level with default group), switch organization tree or zone, sequence. ● Right click group to create group (create group under selected group), rename group, open or close all, new map, delete group (excluding default group). ● Right click access control device node to monitor, extract card info, sync data and reboot device. ● Right click access control channel to support unlock, lock. <p>Global control has one-click NO/NC of all access control channels under emergency.</p> |
| 2 | List/View | <p>List: Access status display and control.</p> <p>View: Video/e-map preview and control.</p> |
| 3 | Event | View event: Access alarm event, normal event and abnormal event. |

Chart 17-1

17.1.1 Organizations/Zones

17.1.1.1 E-Map

E-map supports:

- Drag access control/video channel
- Set range of monitoring
- Set transparency of monitoring range.
- Add hot zone, max 3 levels of zones
- Re-edit map.

See Ch 4.3.

17.1.1.2 Device Control

17.1.1.2.1 Access Control Device

Right click access control device node, see Figure 17-2.

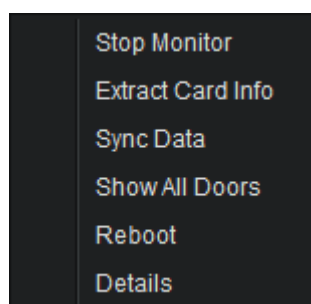

Figure 17-2

| Parameter | Note |
|-------------------|--|
| Monitor | Real-time get device event info. |
| Details` | Device details search, including device name, device IP, device type, and etc. |
| Extract Card Info | Extract device card info and fingerprint info, export. |
| Sync Data | Delete device info (excluding card record and alarm record), sync data in client to device. Data include right info, antipass back info, inter-lock and etc. |
| Show All Doors | Info of all channels under access control device. |
| Reboot Device | Reboot device. |

Chart 17-2

17.1.1.2.2 Access Control Channel Control

Right click access control channel, support the following operations, see Figure 17-3.

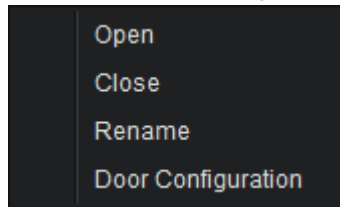

Figure 17-3

| Parameter | Note |
|-------------|--------------------------|
| Open/Close | Remotely open/close door |
| Rename | Edit channel name |
| Door Config | Config of door |

Chart 17-3

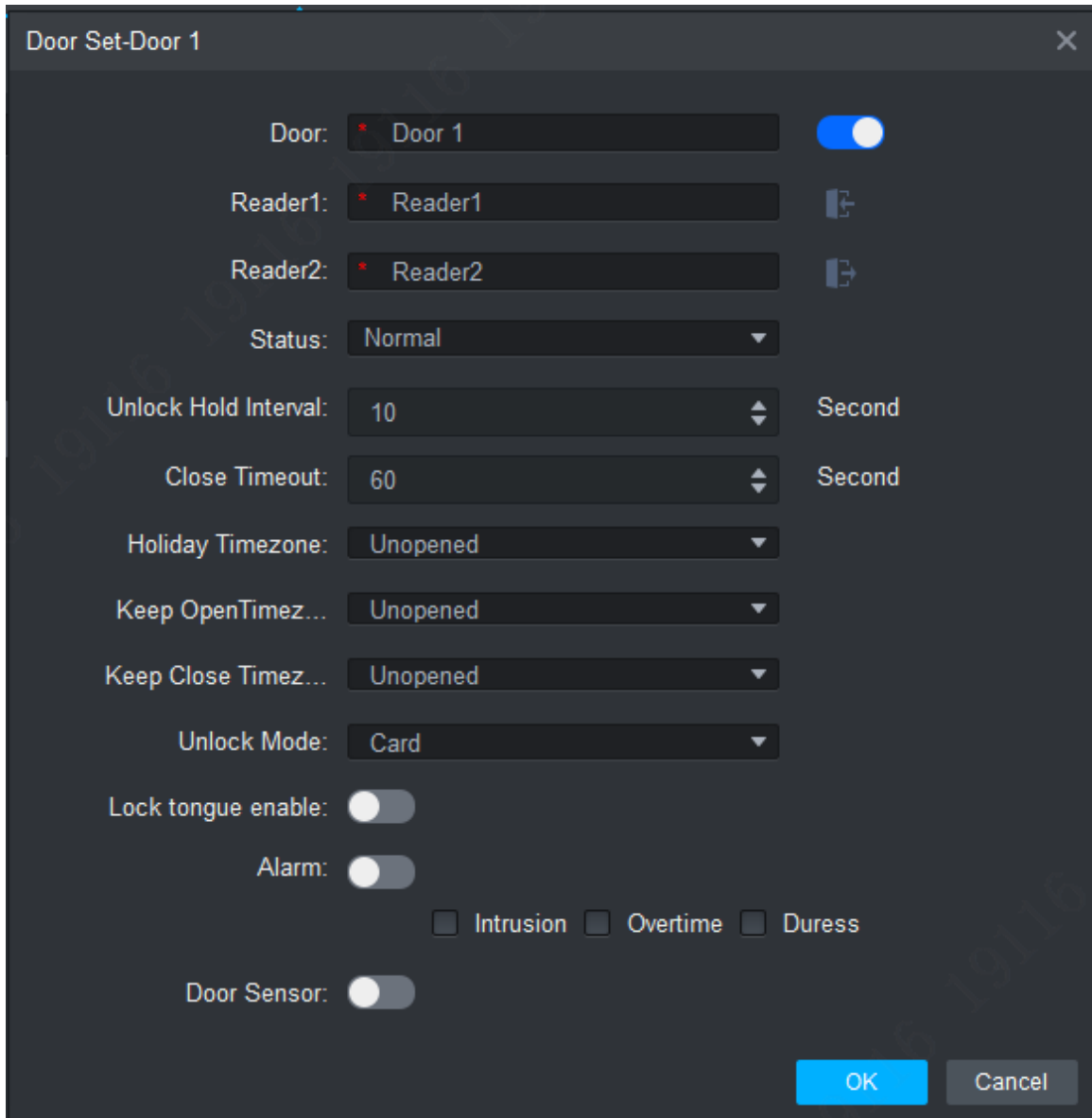



Figure 17-4

| Parameter | Note |
|-------------------------------------|--|
| Door | Customize door name. |
| Reader X Note: X is a number. | <ol style="list-style-type: none"> 1. Modify reader name. 2. Click  or  to switch in/out status. Name reader and set status, the following is by default: <ul style="list-style-type: none"> ■ Single door one-way: 1 in 2 out. ■ Dual door two-way: 1/3 in, 2/4 out. ■ Four door one-way: 1/2/3/4 in |
| Status | Normal, NO and NC |
| Unlock Hold Interval | Unlock hold interval, 1s~600s. |
| Close Timeout | Door close time out, 1s~9999s. |

| Parameter | Note |
|---------------------|---|
| Holiday Time zone | Within access control period, and on holiday, execute holiday period with priority. Default is null. |
| Keep Open Time zone | Within access control period, and NO period, door is NO. Default is null. |
| Unlock Mode | User may unlock by card, password, fingerprint, card+password, card+fingerprint, period. When the door is set to multi-card unlock mode, unlock mode become invalid. By period: Monday~Sunday, 4 periods per day, with period can have different mode. |
| Lock Tongue Enable | Enable this option, so the system gets tongue status of device. |
| Alarm | <ul style="list-style-type: none"> • Duress: force to swipe card and alarm. • Intrusion: intruded and alarm. • Timeout: door not locked and alarm. |
| Door Sensor | Door open/close status is judged by actual status. |

Chart 17-4

17.1.2 List/View

User may live monitor and control access control in list mode, see Figure 17-5.

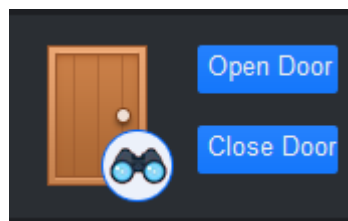

Figure 17-5

User may preview video and e-map in view mode, see Figure 17-6.



Figure 17-6

- Video preview: please refer to Ch 4.2.
- E-map preview: After you edit map, user may drag e-map into video window for preview. Scroll your mouse to zoom in/out; click (or move mouse to range within camera) camera icon on map to open video, right click access control on map to enable/disable access.
- Right click in e-map preview window, see Figure 4-64.

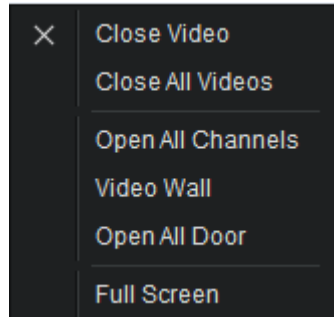



Figure 17-7

| Parameter | Note |
|-------------------|--|
| Close Video | Close current e-map window. |
| Close All Video | Close all video windows. |
| Open All Channels | Open all channels on e-map |
| Video Wall | Output video channel in e-map to video wall. |
| Open All Doors | Open all accesses on e-map |
| Full Screen | Display current window in full screen |

Chart 17-5

User may click  to switch video format. The first three formats are standard formats in your favorites, click  to split interface, see Figure 17-8.

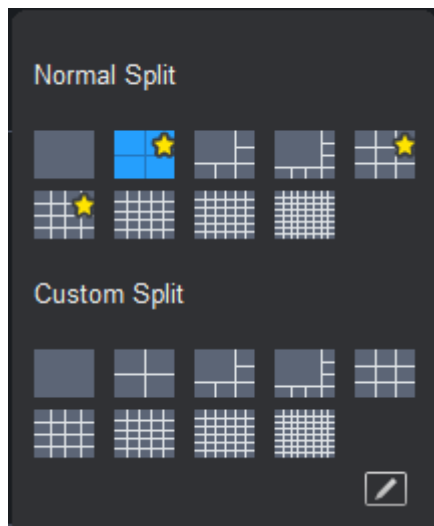

Figure 17-8

User may click add to favorite icon (red heart) to add format into favorites.

Standard split: 1, 4, 6, 8, 9, 16, 25, 36, 64.

Custom split: there are 9 types of custom split, see Figure 4-66.

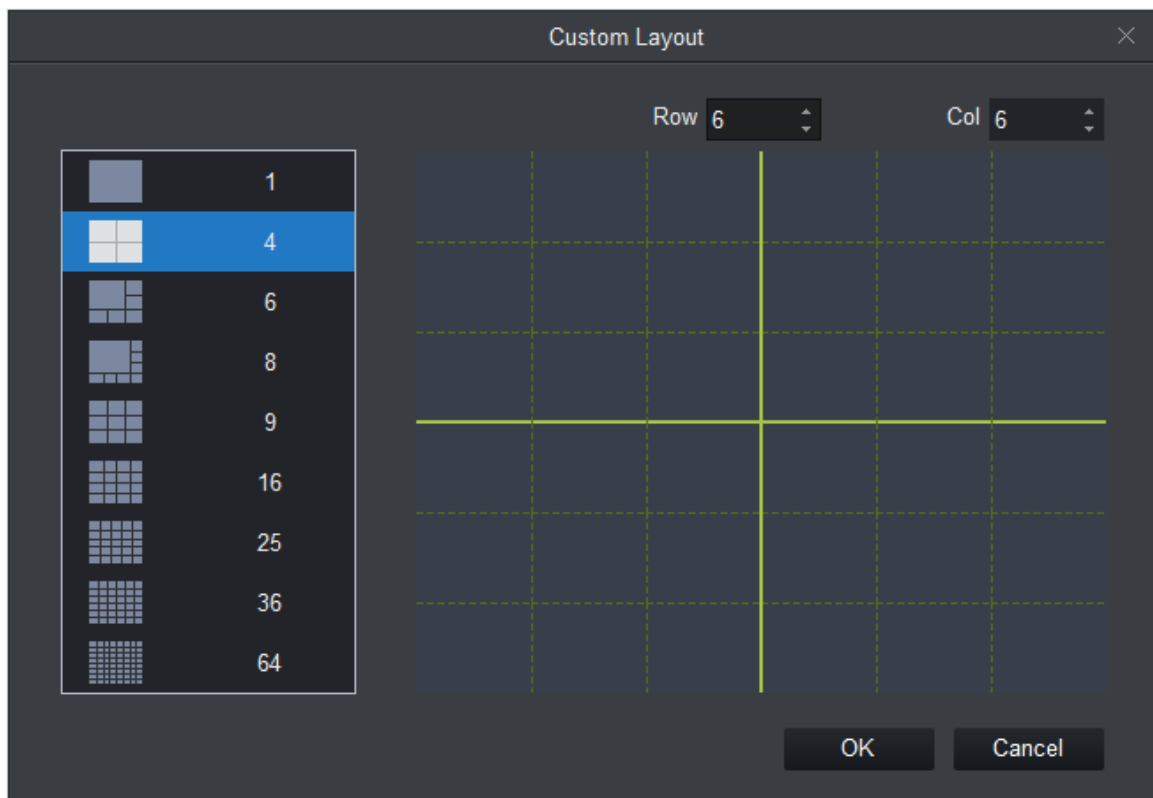

Figure 17-9

17.1.3 Event

User may view all live preview access events and their details of monitored device, see Figure 17-10.

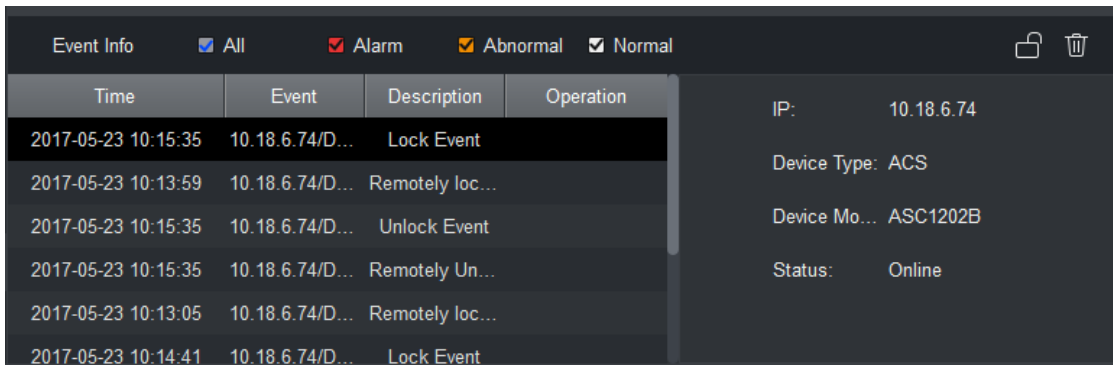





Figure 17-10

| Parameter | Note |
|---|---|
|  | Lock event in current event info, during the period the locked event will not be shown in list but user can search for it in log. |
|  | Clear event in current event info, not delete it from log. |

17.2 User Management

In Access interface, user may click  on the left to enter User Management interface, to manage all users. See Figure 17-11.

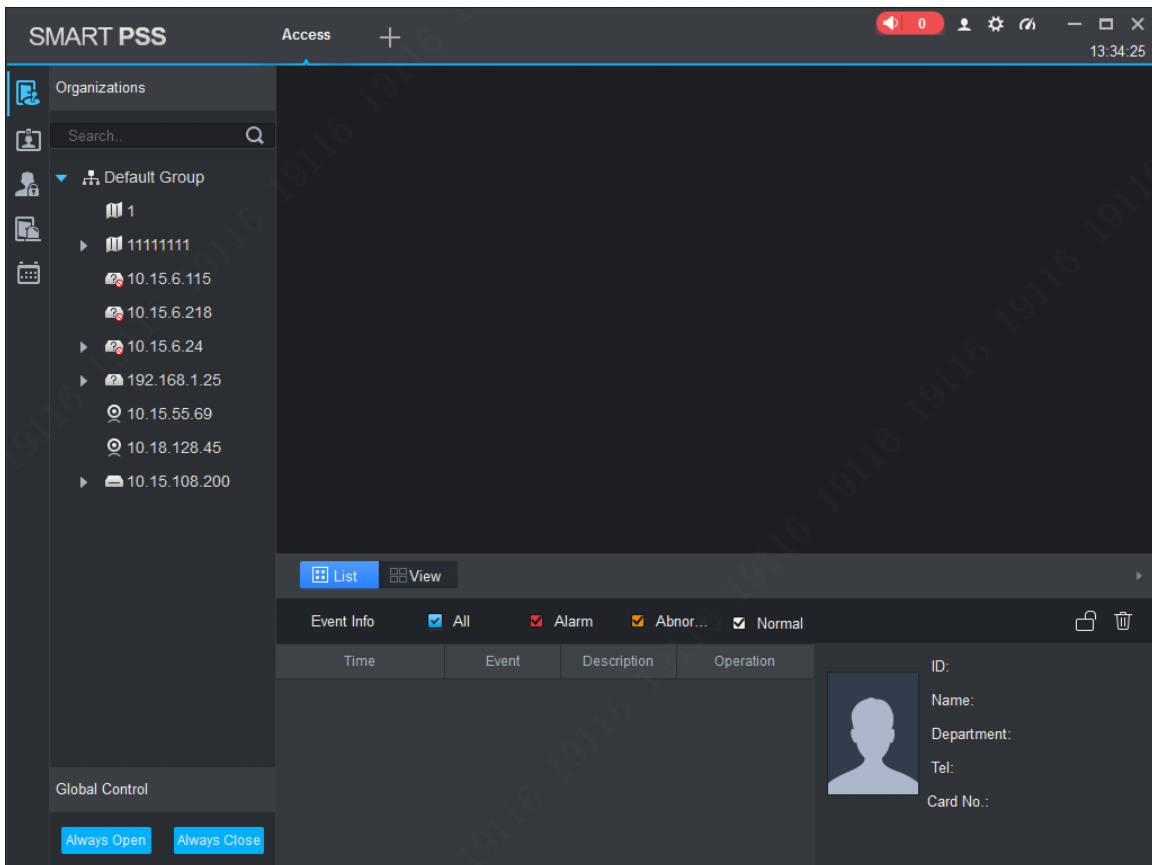

Figure 17-11

| No. | Parameter | Note |
|-----|-----------------|--|
| 1 | Department Tree | Department management, support to add/delete/edit department organization and people count. |
| 2 | User Info | User management, show corresponding user info under department node. Manage user and user card. Sort user by user ID, card no., card type and department. |

17.2.1 Department Management

At department node or blank area in department tree, user may right click to operate, see Figure 17-12.

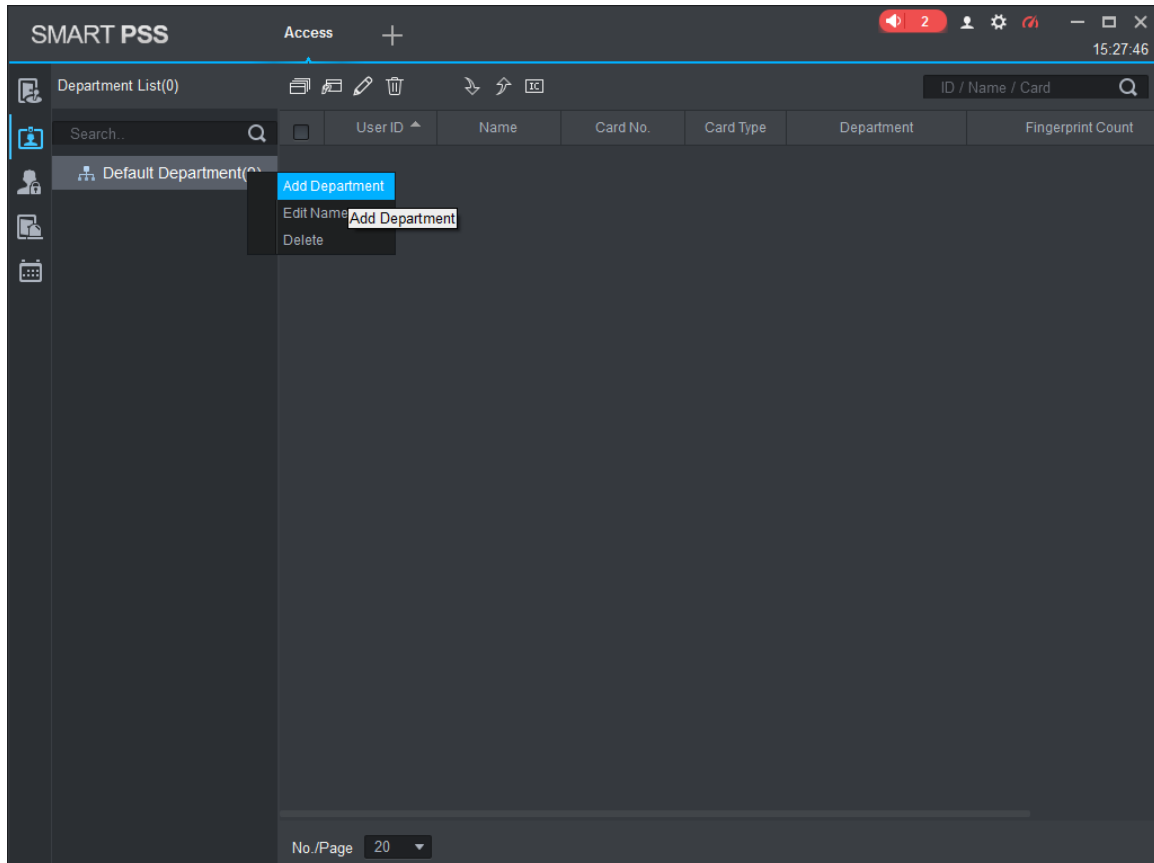

Figure 17-12

| Parameter | Note |
|-----------------|--|
| Add Department | Add department sub node or level 1 department node. Name of departments at same level cannot be repeated. |
| Edit Department | Edit department name. |

| Parameter | Note |
|-------------------|---|
| Delete Department | Delete existing department. User maynot delete department which contains user. |
| Search Department | Support search of department node keyword |

Chart 17-6

17.2.2 User Management

17.2.2.1 Set Card Type

In User Management interface, user may click  button, select type of card you use, see Figure 17-13.

Warning:

If card type and card reader do not match, then user maynot read card no.!

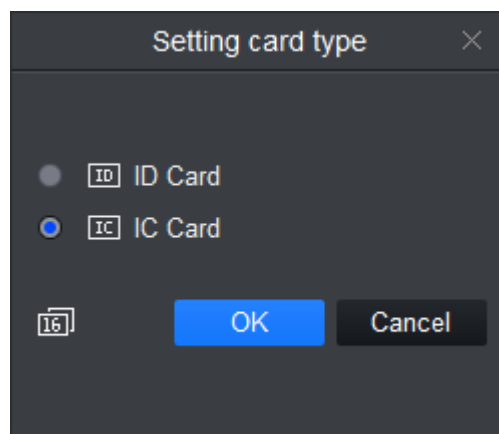

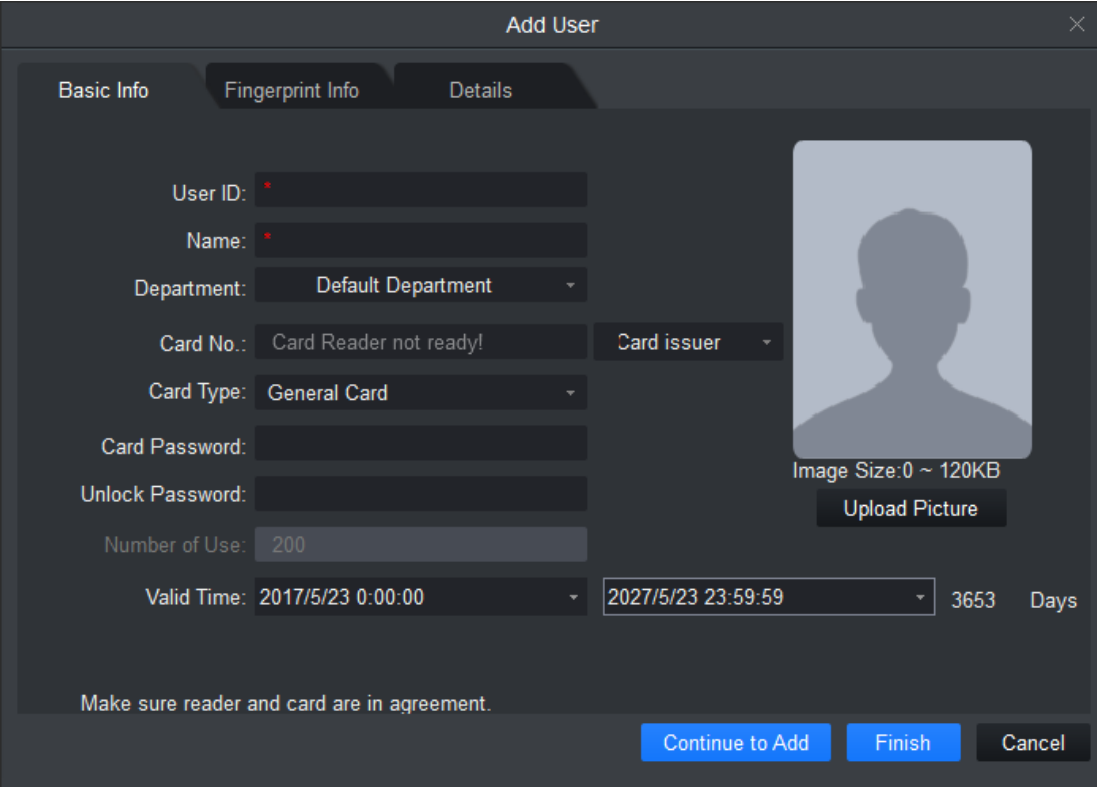

Figure 17-13

17.2.2.2 Add User

17.2.2.2.1 Add Single User

In User Management interface, click  to manually add user info. User info includes basic info, fingerprint info details, see Figure 17-14, Figure 17-15 and Figure 17-16.



The screenshot shows the 'Add User' window with the 'Basic Info' tab selected. The form contains the following fields and controls:

- User ID: *
- Name: *
- Department: Default Department
- Card No.: Card Reader not ready! | Card issuer: *
- Card Type: General Card
- Card Password: *
- Unlock Password: *
- Number of Use: 200
- Valid Time: 2017/5/23 0:00:00 to 2027/5/23 23:59:59 (3653 Days)
- Image upload area: Image Size: 0 ~ 120KB, Upload Picture button
- Footer: Make sure reader and card are in agreement. | Continue to Add, Finish, Cancel buttons

Figure 17-14

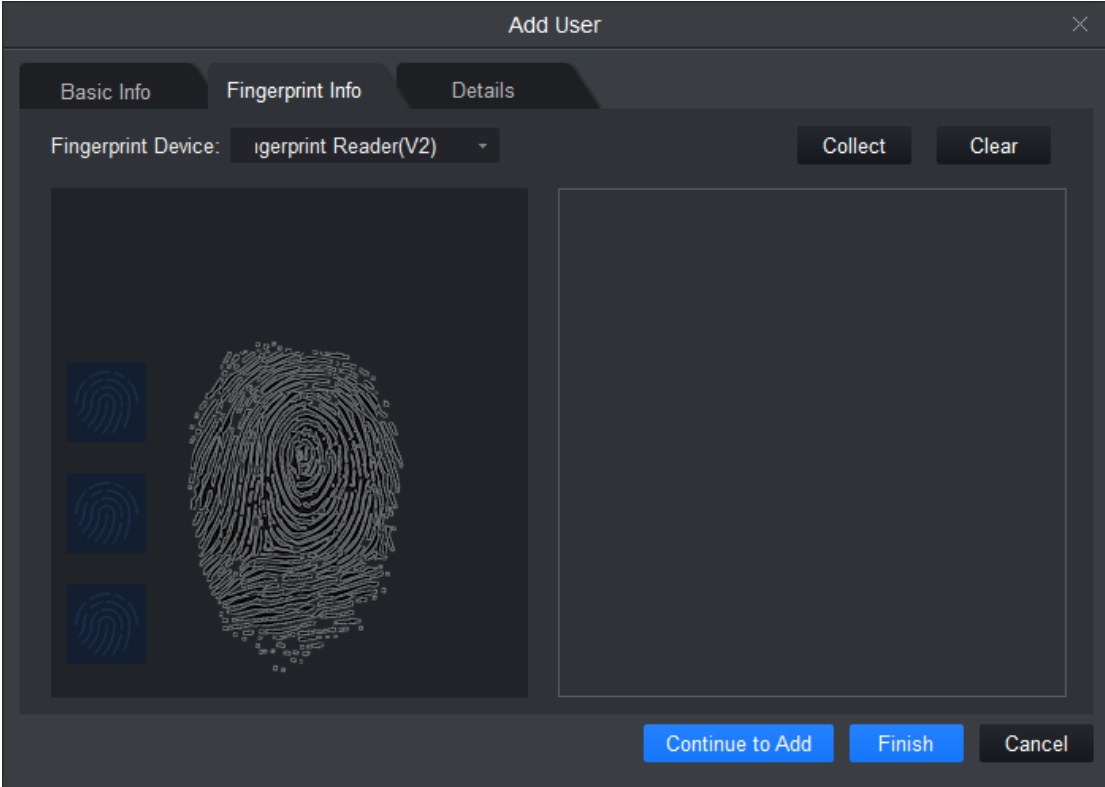

The screenshot shows the 'Add User' window with the 'Fingerprint Info' tab selected. The form contains the following fields and controls:

- Fingerprint Device: ingerprint Reader(V2)
- Buttons: Collect, Clear
- Main area: Large fingerprint image being captured, three smaller thumbnail images on the left
- Footer: Continue to Add, Finish, Cancel buttons

Figure 17-15

The screenshot shows a dark-themed 'Add User' window with three tabs: 'Basic Info', 'Fingerprint Info', and 'Details'. The 'Basic Info' tab is selected. It contains the following fields:

- Gender: Male Female
- Title:
- DOB:
- Tel:
- Email:
- Mailing Address:
- Remark:
- ID Type:
- ID No.:
- Company:
- Occupation:
- Entry Time:
- Resign Time:

At the bottom right, there are three buttons: 'Continue to Add' (blue), 'Finish' (blue), and 'Cancel' (grey).

Figure 17-16

| Parameter | Note |
|------------------|--|
| Basic Info | <p>User ID 【mandatory】</p> <p>Name 【mandatory】</p> <p>Department 【Auto】</p> <p>Card no.: input by card reader and manually</p> <p>Card type: general card, VIP card, guest card, blacklist card, patrol card, and duress card</p> <p>Unlock password: only used for unlock via password</p> <p>Card password: used for card+password unlock</p> <p>Number of use: only for guest card</p> <p>Validity: card validity, 10 years by default</p> <p>Picture: user photo, max 120K</p> <p>Note:</p> <p>Card no. and user ID cannot be repeated.</p> |
| Fingerprint Info | <p>Collect fingerprint via fingerprint device and reader</p> <p>Each user can have up to 3 fingerprints</p> <p>Support input of fingerprint name</p> |

| Parameter | Note |
|-----------|-----------------------------------|
| Details | Gender, title, education and etc. |

Chart 17-7

17.2.2.2.2 Batch Add

In User Management interface, user may click  button to batch issue card, see Figure 17-17.

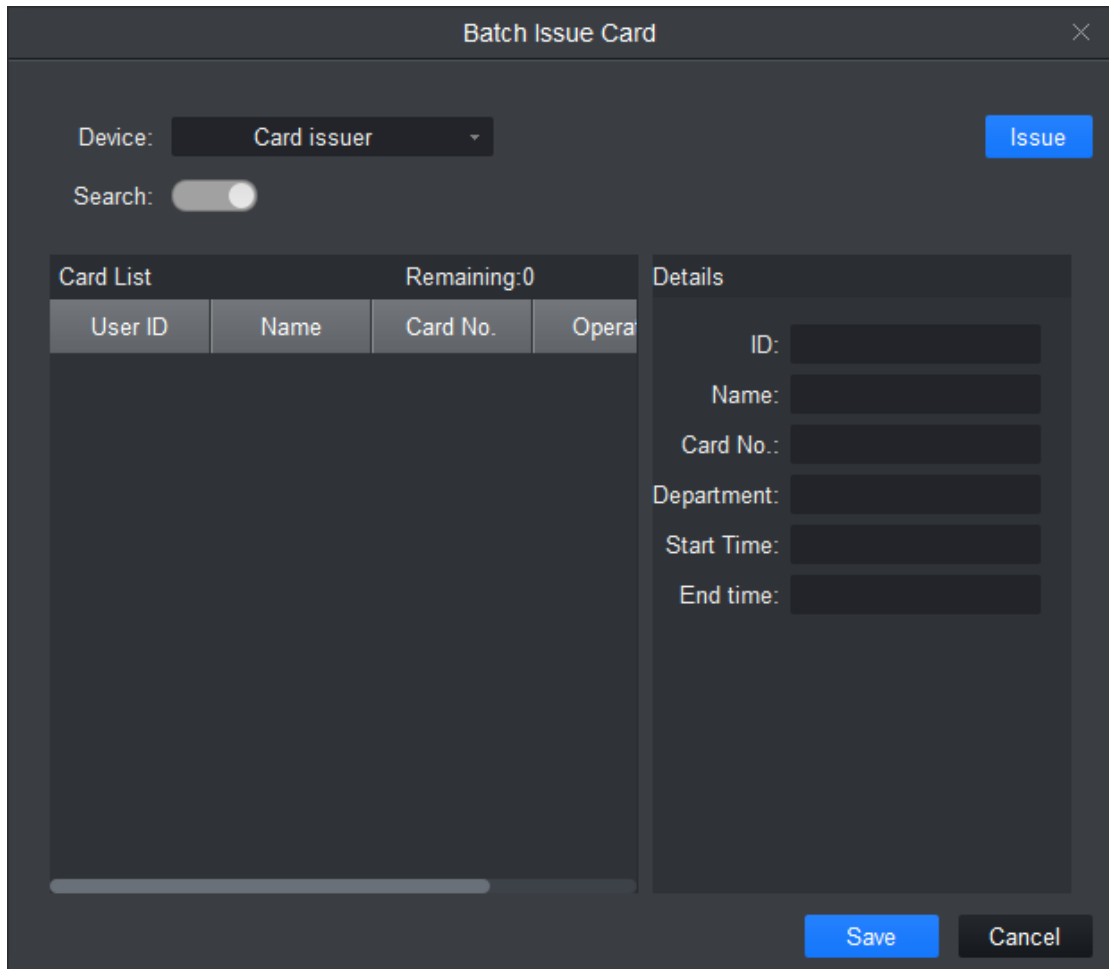

Batch Issue Card

Device: Card issuer Issue

Search:

| Card List | | Remaining:0 | |
|-----------|------|-------------|-------|
| User ID | Name | Card No. | Opera |
| | | | |

Details

ID:

Name:

Card No.:

Department:

Start Time:

End time:

Save Cancel

Figure 17-17

| Parameter | Note |
|----------------------------------|---|
| Batch Issue Card by User | <p>Manually check user to want to issue card to 【auto filter out users already have card】</p> <p>Click Batch</p> <p>User select card issuing device: support card issuer and card reader of controller.</p> <p>Click read card no, and device starts to read.</p> <p>Place card on device, link user to card no. one by one.</p> <p>Click save to complete card issuing.</p> |
| Batch Issue Card by User ID/Name | <p>User click to batch issue card</p> <p>Enable <input checked="" type="checkbox"/> Work ID: </p> <p>User can enter user ID or name to fuzzy search.</p> <p>Click to get user and auto complete adding user or directly click search to get first 200 unauthorized users. .</p> <p>Click read card no., so device starts to read card no.</p> <p>Place card on device one by one to link card to work ID by sequence.</p> <p>Click save to complete.</p> |

Chart 17-8

In User Management, user may click  button to edit user, see Figure 17-18.

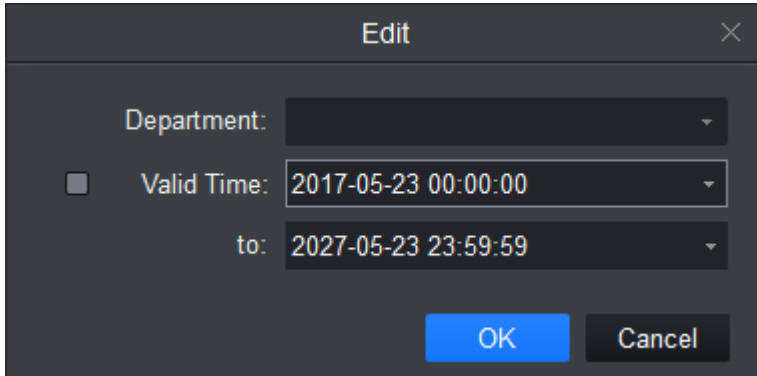





Figure 17-18

| Parameter | Note |
|------------|---|
| Department | <p>Check user you want to edit.</p> <p>Click .</p> <p>Select new department.</p> <p>Click OK.</p> <p>Complete.</p> |
| Validity | <p>Check user you want to edit.</p> <p>Click .</p> <p>Check valid time.</p> <p>Set time.</p> <p>Modified valid time will be sent to device.</p> <p>Complete.</p> |

17.2.2.2.3 Delete

In User Management interface, click  button to delete user. Check user you want to delete, click Delete. Confirm that all information and rights of the user you are doing to delete will be deleted from the device.

17.2.2.2.4 Import/Export

Warning:

If imported data (User ID/card no.) already exists, it will not import the information.

User may click either of  or  to import/export user info.



Import/export info includes: user ID, name, card no., card type, department, fingerprint name, fingerprint name.

Note:

During data importing, it auto generates department.

17.2.2.2.5 More Operations

In User Management interface, user may click .

| Parameter | Note |
|---|-------------------|
|  | Modify user info. |
|  | Delete user info. |



| Parameter | Note |
|---|--|
|  | Clear user card no. and delete card info in device. |
|  | Freeze card no. in device. User may click unfreeze if you want to restore frozen card. |

Chart 17-9

In User Management interface, user may click  to search keyword of user.

Note:

User ID and name support fuzzy search.

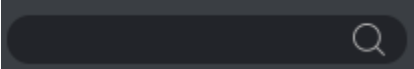
Card no. supports accurate search.

17.3 Permission Management

In Access interface, user may click  on the left to enter Permission Management which allows management of right about user issuing card.

17.3.1 Period Setup

In Permission Management interface, click Period Setup to set specific reader to be valid with specific period and not valid on other periods, as well as set that user can only access a specific door within a specific period. Period is used for NO period, holiday period, first card period, remote verification period, door group right period.

Step 1. Click , select Period Setup.

Step 2. Click Add, see Figure 17-19.

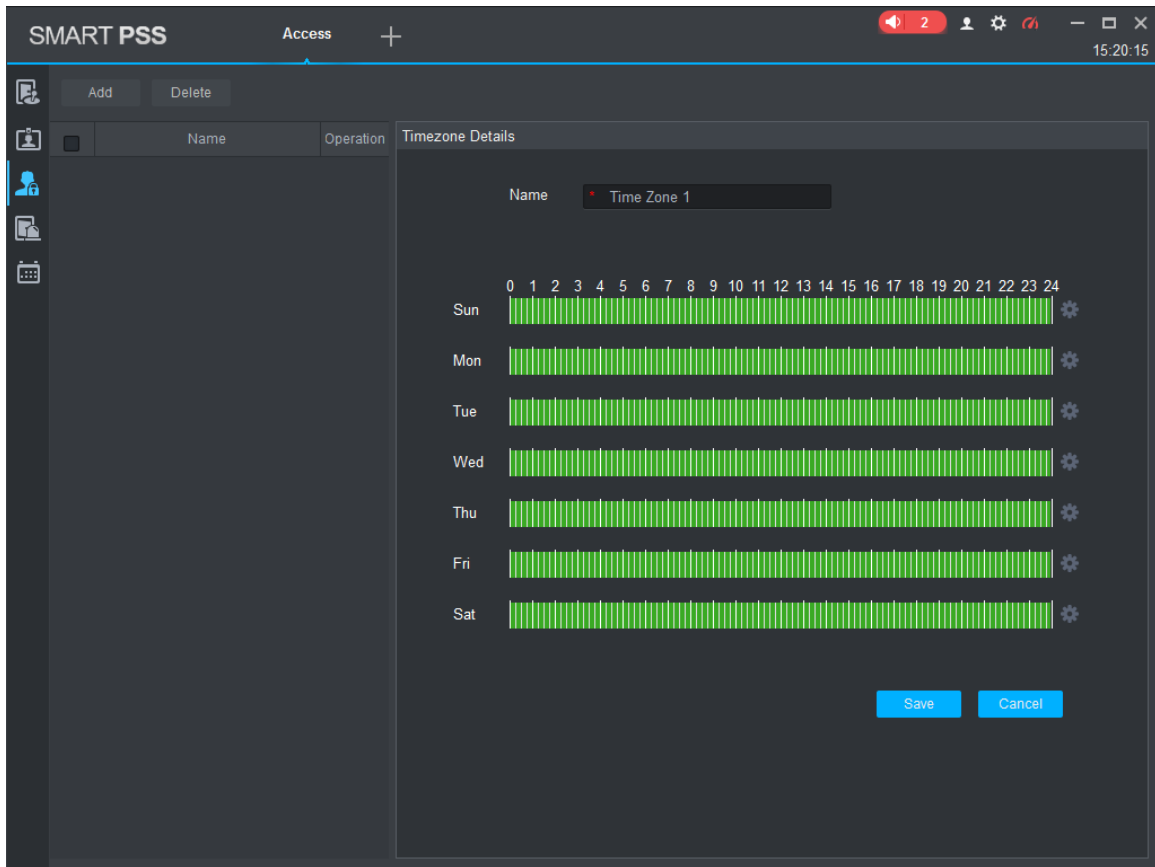

Figure 17-19

Step 3. Enter period name.

Step 4. Select daily period for Monday to Sunday.

Note:

A device supports to 128 periods setup with daily limit of 4 periods.

17.3.2 Holiday Setup

In Permission Setup interface, click Holiday Setup to set different access period from general period.



Step 1. Click , select Holiday Setup.

Step 2. Click Add, see Figure 17-20.

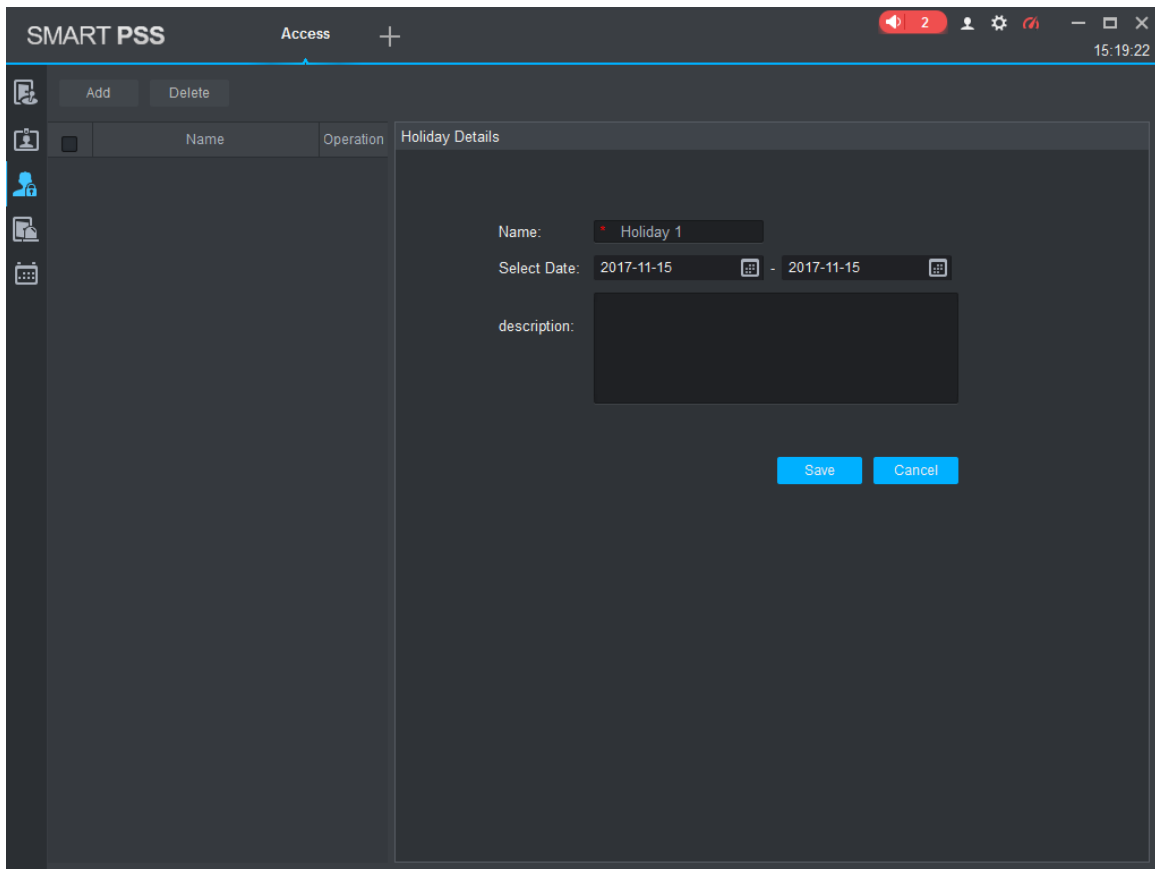

Figure 17-20

Step 3. Enter name.

Step 4. Select range.

Note:

Within holiday period, holiday has priority in execution. Holiday period is for access only.

17.3.3 Door Group Right



In User Management interface, user may click , and set a specific period of time, a specific door or door group can be unlocked via verification, see Figure 17-21.

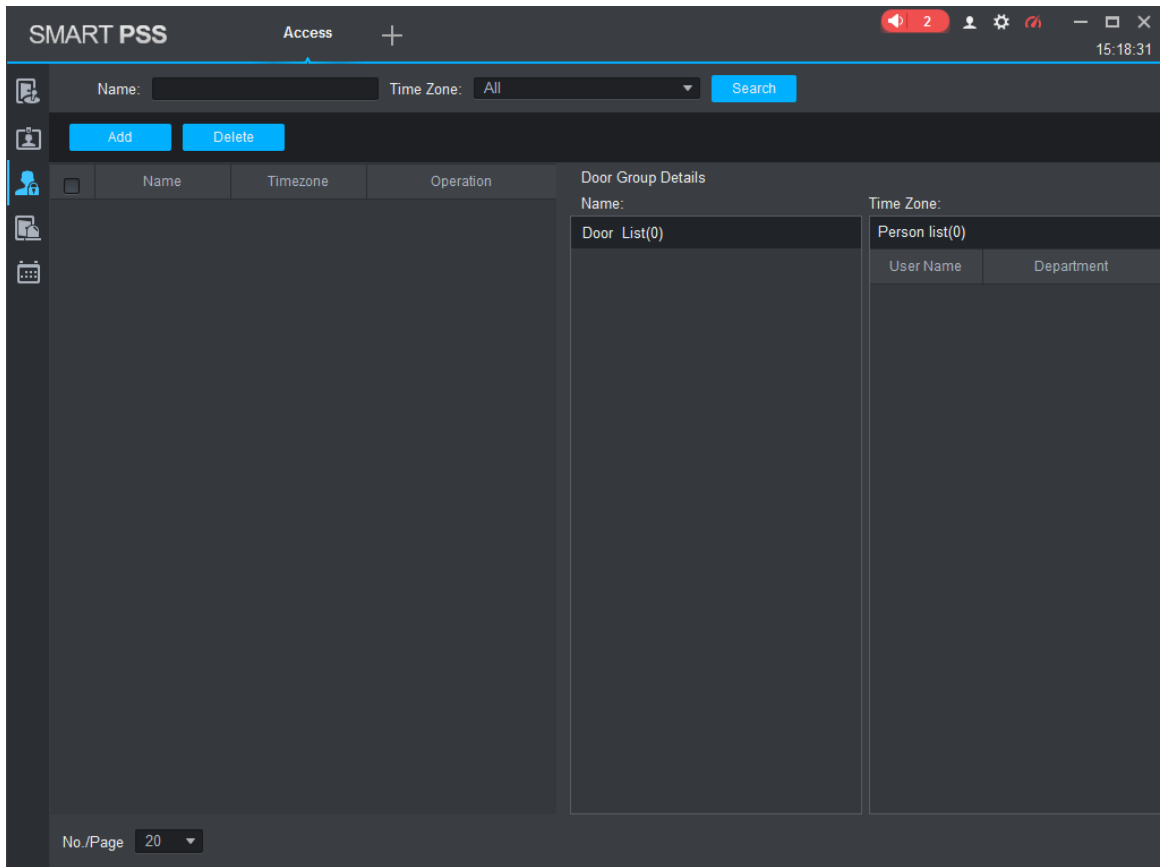

Figure 17-21

| No. | Parameter | Note |
|-----|--------------------|---------------------------------------|
| 1 | Door Group Info | Client door group info list |
| 2 | Door Group Details | Details of current door group |
| 3 | User Info | User right info of current door group |

Chart 17-10

In Door Group Right interface, click Add, see Figure 17-22.

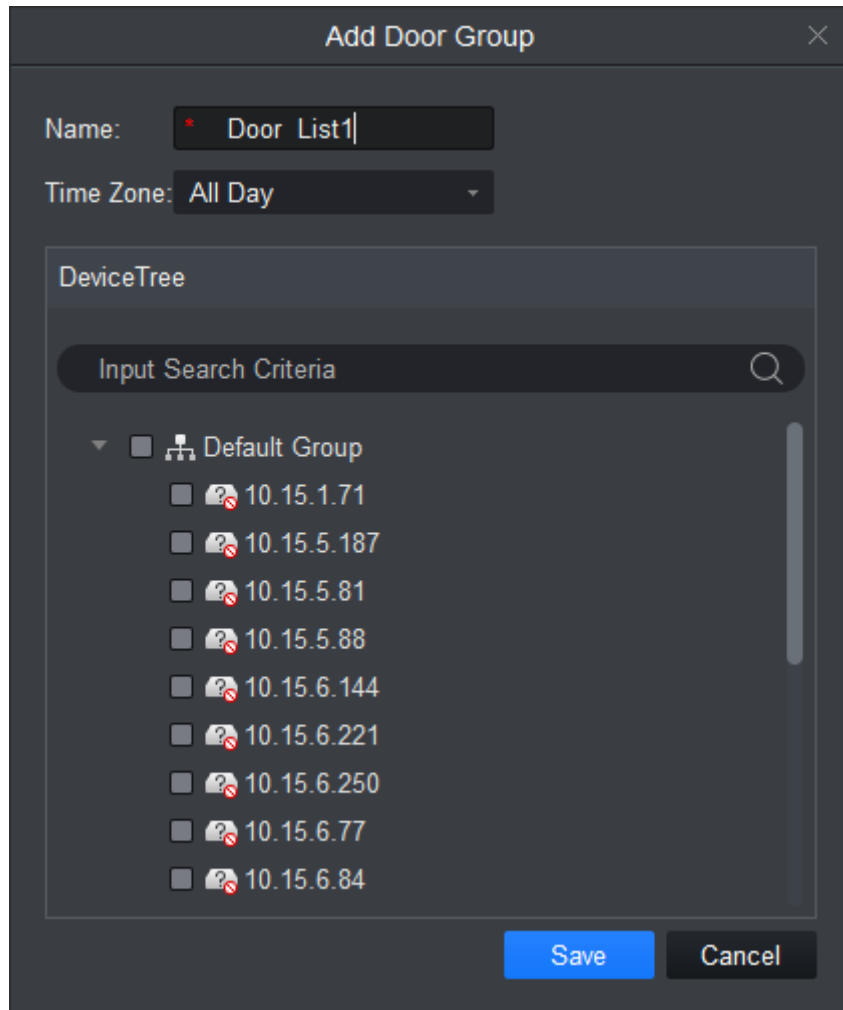



Figure 17-22

- Step 1. Enter name of door group, which cannot repeat existing door group name.
- Step 2. Select access period.
- Step 3. Check door, click Save.

Click  button to re-edit door group info.

Warning:

Door group name cannot be repeated!

In Door Group Right interface, click  to add use right, see Figure 17-23.

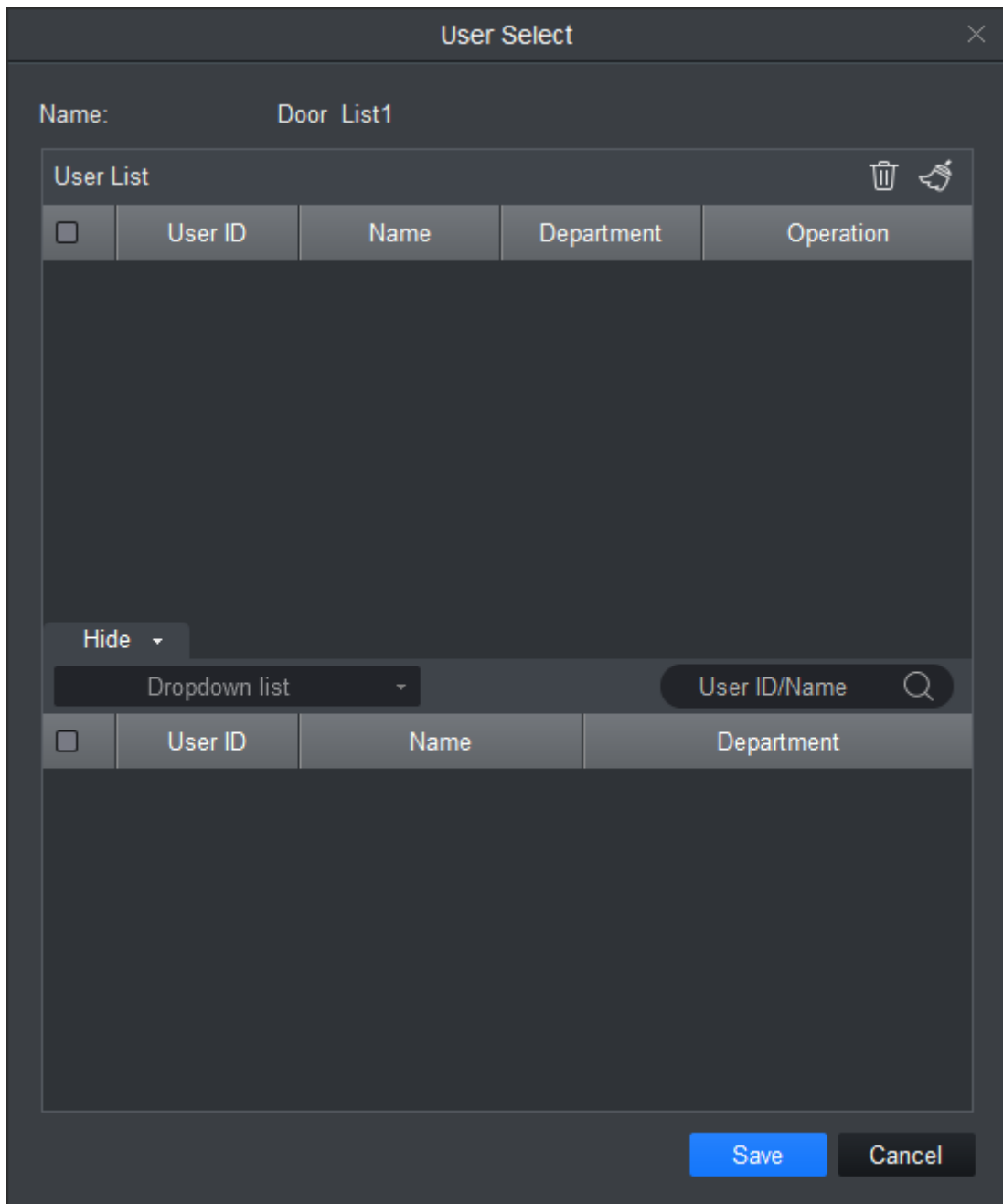

Figure 17-23

| No. | Parameter | Note |
|-----|-------------|--|
| 1 | User List | Existing user info with door group right |
| 2 | Search List | Info of user without door group right |

Chart 17-11

- Step 1. In search list dropdown list, select department of user you want to add or directly enter user ID or name.
- Step 2. In search list check searched user and add to list.
- Step 3. User may delete user who already has right.
- Step 4. Click Save, to complete the selected user into all door groups.

Note:

In search list filter out user who do not have card no. info.

In Door Group Right interface, user may click  button to delete all information and right of the door group in the system.

Warning:

During right issuing process, please sure client and device are well connected.

17.3.4 User Right

In User Management interface, user may click  in User Right interface to add specific user into access right list, or delete specific user from list.

Step 1. Check or cancel checked door group.

Step 2. Click OK as to confirm cancellation or adding of personal user right.

17.3.5 First Card Unlock

After you set first card unlock function, when everyday you are first user swipe card, you must pass that verification before user may unlock at access.

Step 1. Click , select First Card Unlock, see Figure 17-24.

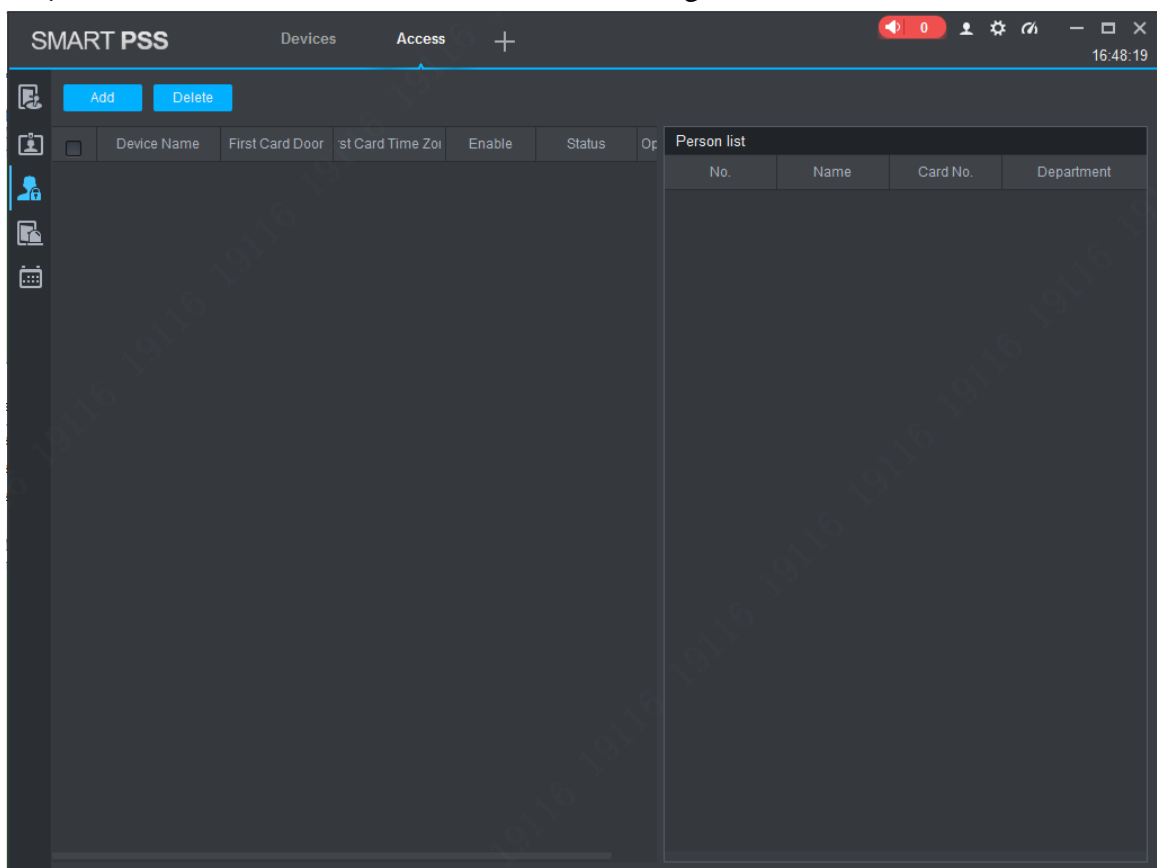

Figure 17-24

Step 2. Click Add, see Figure 17-25.

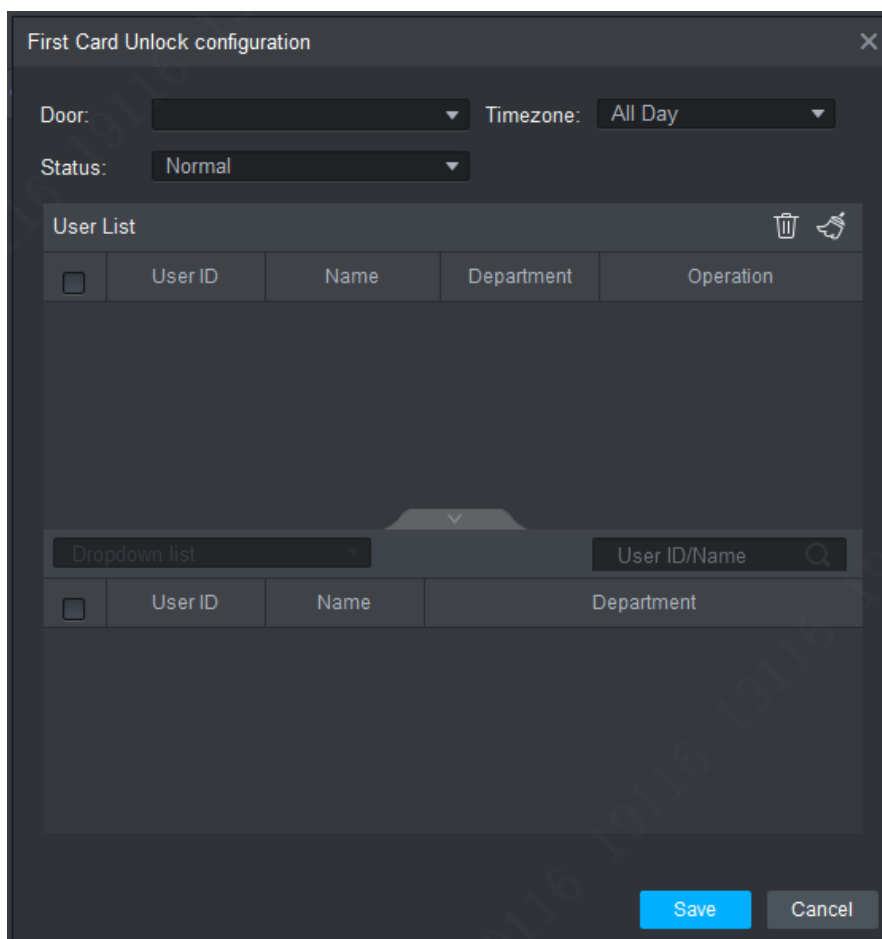

Figure 17-25

- Step 3. Select door, period, and status of first card. Status means status after you swipe card.
- Step 4. In search list, search user by department, no. or name.
- Step 5. Check user.
- Step 6. Click Save.

Warning:

For user who is auto filtered out in search list due to lack of right of the door, he/she must be given right of this door by first card right holder.

17.3.6 Multi-door Lock

User may click Multi-door Lock to set that a specific door can be unlocked only when specific users of a group all pass verification in a specific order.



- Step 1. Click , select Multi-door Lock.
- Step 2. Click User Group Manager, see Figure 17-26.

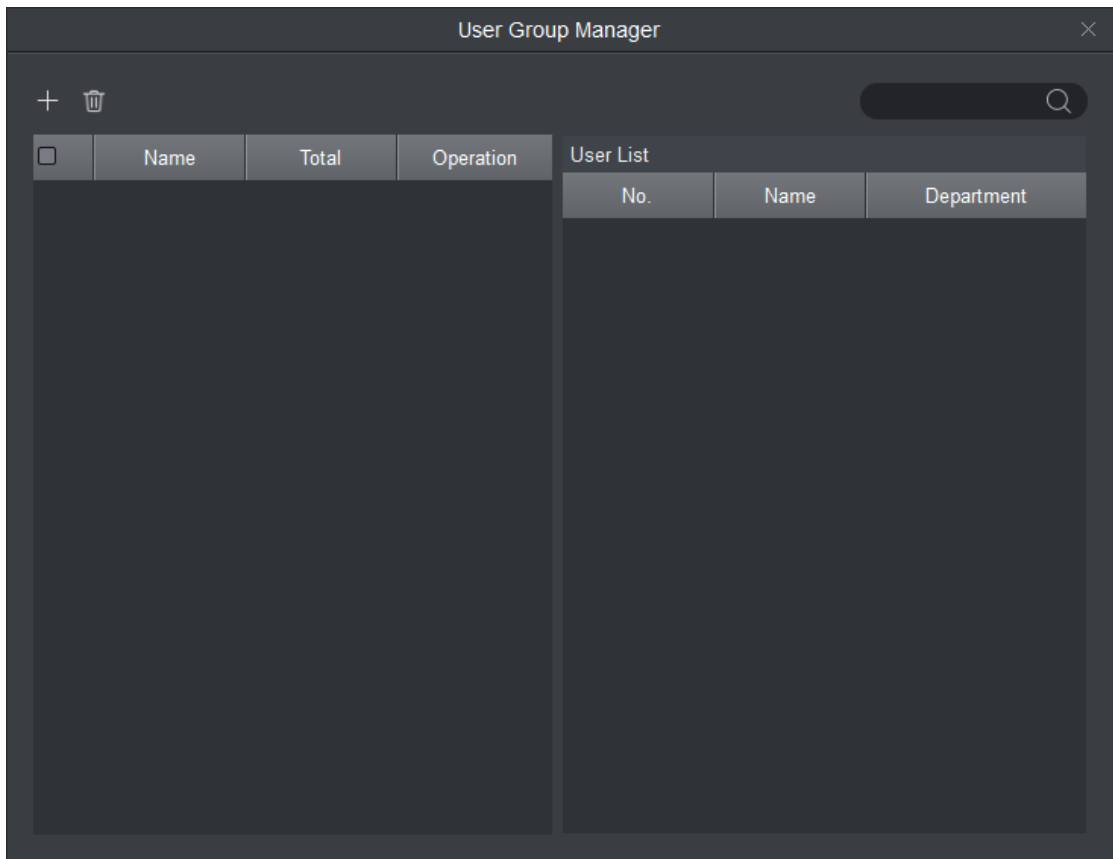



Figure 17-26

Step 3. In User Group Management interface, click , see Figure 17-27.

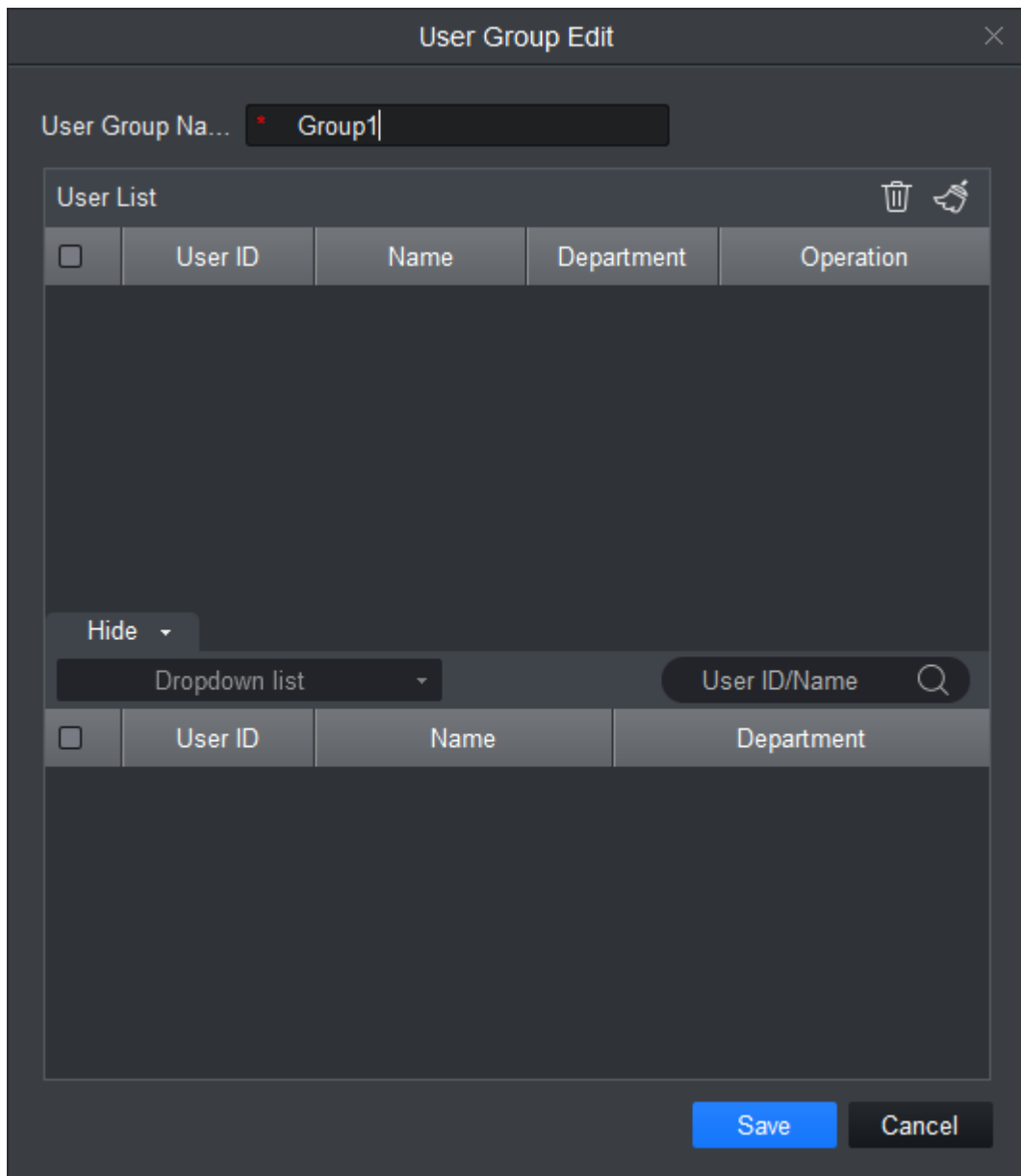



Figure 17-27

- Step 4. Select group member.
- Step 5. Save to complete adding.
- Step 6. In Multi-door Unlock interface, click Add.
- Step 7. Select door you want to enable multi-door unlock.
- Step 8. In Multi-door unlock setup interface, check group.
- Step 9. Fill in valid number of user for each group.
- Step 10. Select unlock method for each group. (card, password and fingerprint).
- Step 11. Click  to adjust sequence of unlock.
- Step 12. Click Save.

Note:

- A group can contain up to 64 users.

- A door with enabled multi-card unlock supports up to 4 groups to verify at the same time, total number of user cannot exceed 64; total valid user cannot exceed 5.

17.3.7 Anti-pass Back

In Permission Management interface, click Anti-pass Back to set verification user. A user verifies at door A must verify at door A again when exits since card record must match one to one. If a user does not verify when enters, he/she will not pass verification when exits.

Step 1. Click , select Anti-pass Back.

Step 2. User may click Add in Anti-pass Back interface. See Figure 17-28.

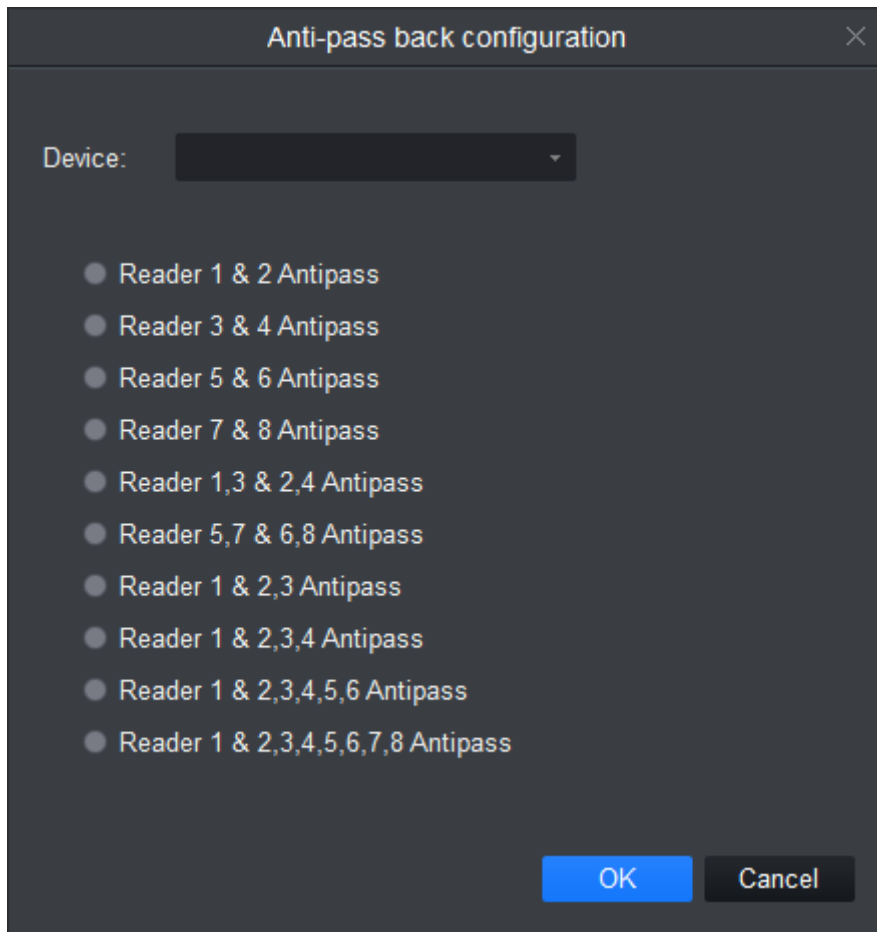

Figure 17-28

Step 3. Select access controller to use anti-pass back.

Step 4. Select anti-pass back rule according to access controller.

Step 5. Confirm.

Note:

Rule of anti-pass back:

Unit/single door controller: door reader anti-pass back.

Dual door controller/four door controller: reader 1 and 2 anti-pass back, reader 3 and 4 anti-pass back, reader 1/3 and 2/4 anti-pass back, reader 1 and 2/3/4 anti-pass back.

Four door controller: reader 1 and 2 anti-pass back, reader 3 and reader 4 anti-pass back, reader 1/3 and 2/4 anti-pass back, reader 1 and 2/3 anti-pass back, reader 1 and 2/3/4 anti-pass back.

17.3.8 Inter-door Lock

In Permission Management interface, click Inter-door Lock, to set inter-lock between two doors on one access controller. When one door is unlocked, other doors will be locked. If you want to unlock one door (under normal status), all of the others shall be locked, otherwise user maynot unlock this door.



Step 1. Click , select Inter-door Lock.

Step 2. User may click Add in Inter-door Lock interface. See Figure 17-29.

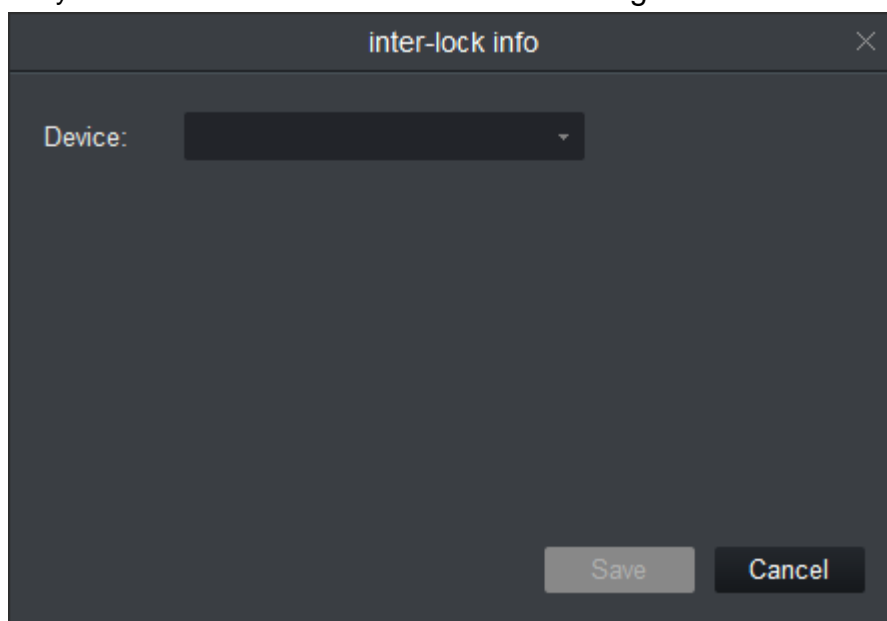

Figure 17-29

Step 3. Select access controller to inter-lock.

Step 4. Select rule of inter-lock.

Step 5. Confirm.

Note:

Role of inter-lock:

Single door controller has no inter-lock.

Dual door controller: 1-2 door inter-lock.

Four door controller: 1-2 door inter-lock, 3-4 door inter-lock, 1-2-3 door inter-lock, 1-2-3-4 door inter-lock.

17.3.9 Remote Verification

In Permission Management interface, user may click Remote Verification to ask the client to let user who passes verification enter within certain period, and admin will judge whether to unlock or not.



Step 1. Click , select Remote Verification.

Step 2. User may click Add in Remote Verification interface. See Figure 17-30.

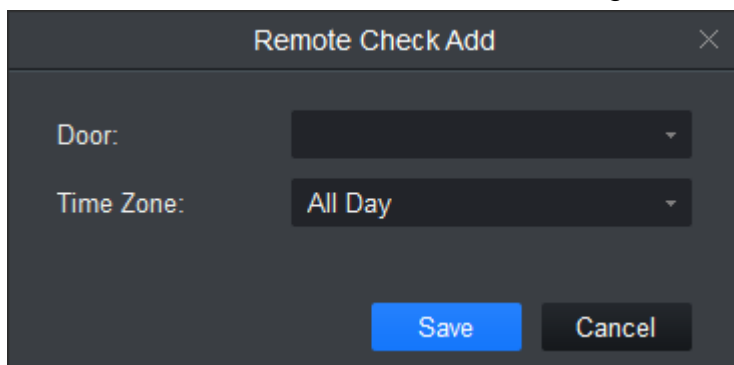

Figure 17-30

Step 3. Select door and time to enable remote verification.

Step 4. Save.

17.4 Event Configuration

In Access interface, user may click Event Configuration. User may set that when a input point inside access system triggers a specific event, client will have video link(live preview/record), link event includes: alarm, abnormal, normal event, link event pop-up plus display in log.

Please refer to the following for configuration of event scheme.

Step 1. Click . See Figure 17-31.

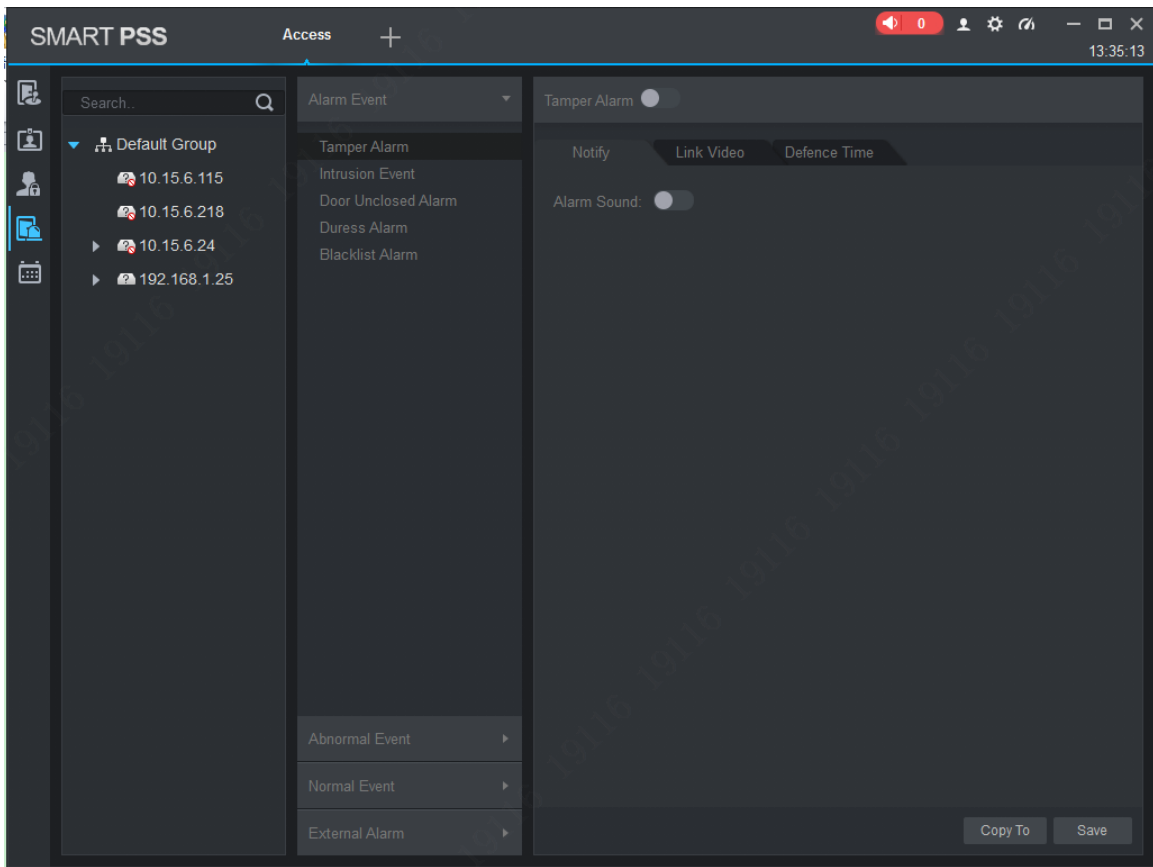

Figure 17-31

Step 2. Select device channel.

Step 3. Select alarm event.

| Event Type | Description |
|----------------|---|
| Alarm Event | Chassis alarm: alarm triggered when card reader of the controller is forced to be removed. |
| | Intrusion alarm: Excluding normal door open conditions, other door open conditions detected by door sensor 1 |
| | Duress alarm: Alarm triggered when door is opened by duress card (fingerprint). |
| | Door left open alarm: door remained open exceeding set time |
| | Blacklist alarm: Alarm triggered when door is opened via card on blacklist. |
| Abnormal Event | Unauthorized or card lost: alarm triggered when the card has no right to unlock this door or it has been reported lost. |

| Event Type | Description |
|--------------|--|
| | Card suspended: After the card is suspended, it cannot be used. Event is triggered at verification. |
| | Unlock mode error: Event triggered when verification method and unlock method do not match. |
| | Card validity error: Alarm is triggered when current time is not within card validity. |
| | Period error: Alarm is triggered when verification of current period is not in access period. |
| | Holiday unlock period error: Alarm is triggered when verification of current period is not in holiday period. |
| | Incorrect first card: enable first card right, alarm is triggered when user unlock not using first card. |
| | Inter-lock mode: Door with set inter-lock rule is unlocked, alarm it triggered when the other door is unlocked. |
| | Anti-pass back mode: When one enters via verification but exits without verification, alarm is triggered at his/her next verification for entry. |
| Normal Event | Lock event: triggered when auto lock or door sensor detects door is locked |
| | Card unlock: Triggered after passing card verification, door is unlocked |
| | Fingerprint unlock: Triggered when door is unlocked after passing fingerprint verification. |
| | Card + fingerprint unlock: Triggered when door is unlocked after passing card and fingerprint verification. |
| | Card +password unlock: Triggered when door is unlocked after passing card and password verification. |
| | Password unlock: Triggered when door is opened via password. |
| | Button unlock: Triggered when door is opened via button. |
| | Multi-card unlock: Triggered when the first card in multi-card unlock mode passes verification. |

| Event Type | Description |
|------------|---|
| | Remote verification: Triggered when a user passes device verification and is asking for client verification for door under remote verification. |

Chart 17-12

Step 4. Set alarm link, see Ch 11.2.

Step 5. Click Save.

17.5 Log

In Access interface, user may click Log. User may search for log according to criteria.

Step 1. Click , see Figure 17-32.

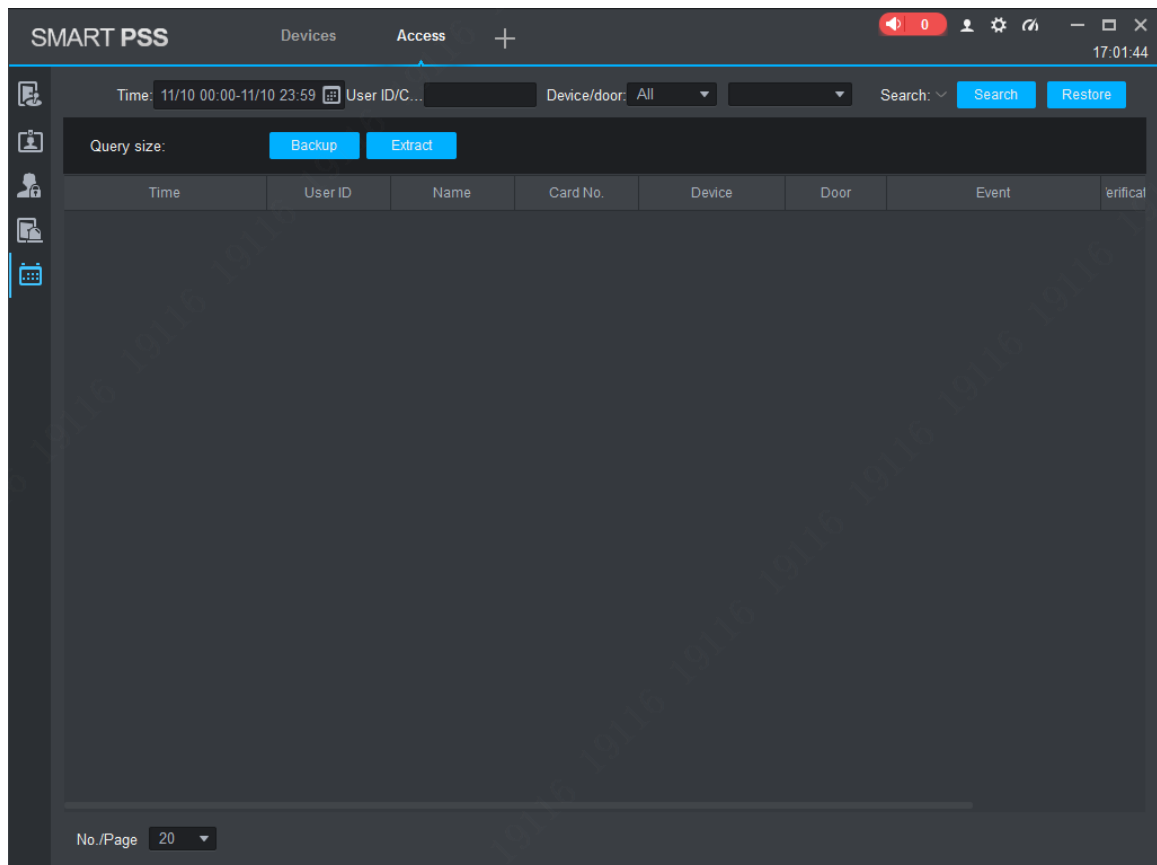

Figure 17-32

Step 2. Set search criteria. Search can cross up to 2 days.

Step 3. Click Search, see Figure 17-33.

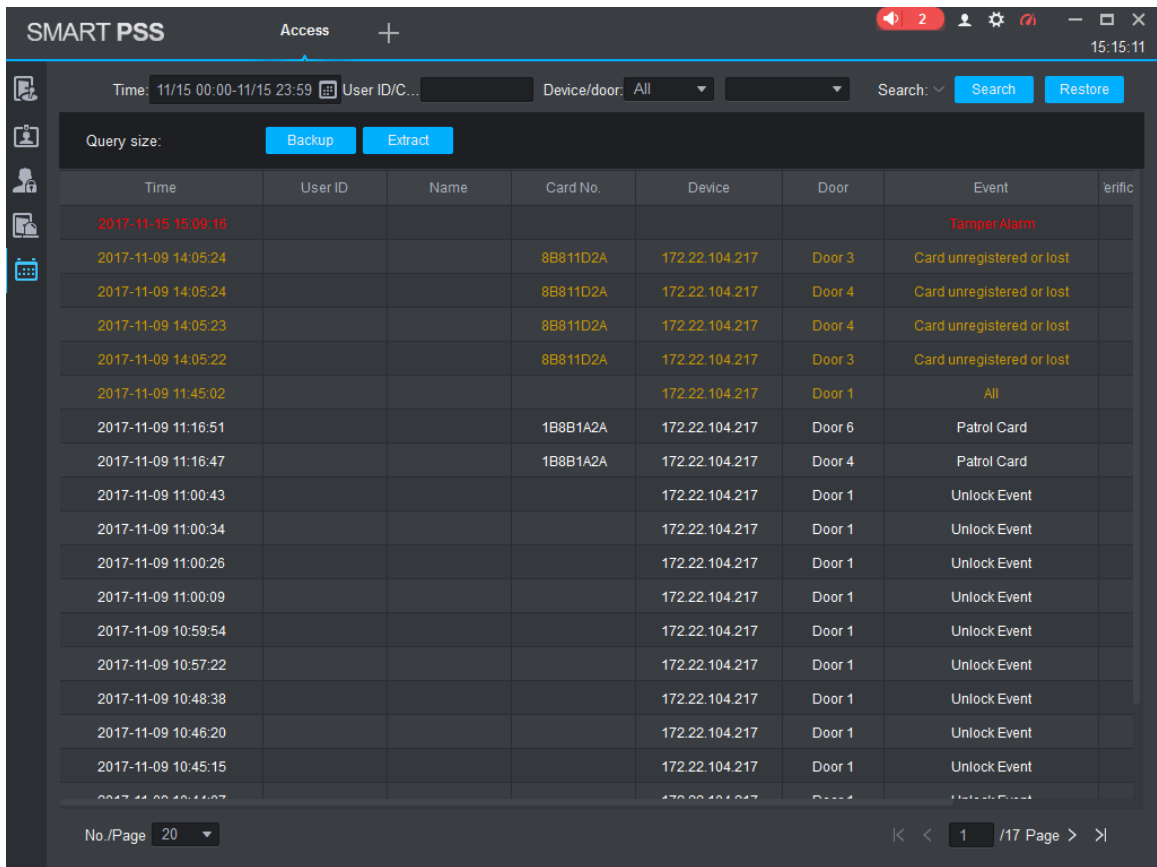
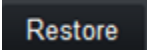
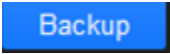
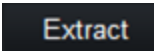



Figure 17-33

User may reset search criteria, export search result and view record.

-  **Restore**, restore criteria.
-  **Backup**, export searched log.
-  **Extract**, extract log info of all devices or selected devices.
-  **View record**, view record.

18. Attendance

It integrates time attendance, and effectively manage and configure devices to fulfill function of time attendance module.

Click , in New interface, select Attendance.

18.1 Console

When you use access control device as time attendance, please set A&C device as time attendance in console. If it is paired with time attendance, then user may extract card info on time attendance.

18.1.1 ACS Attendance Node Setup

Step 1. Click . See Figure 18-1.

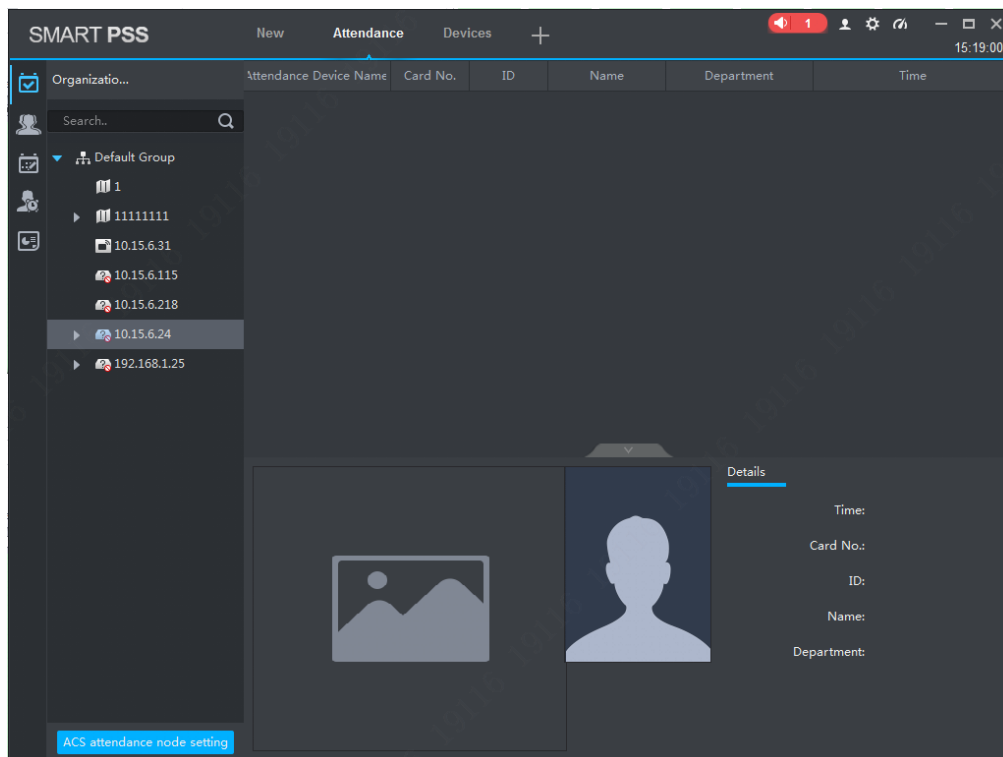

Figure 18-1

Step 2. Click , see

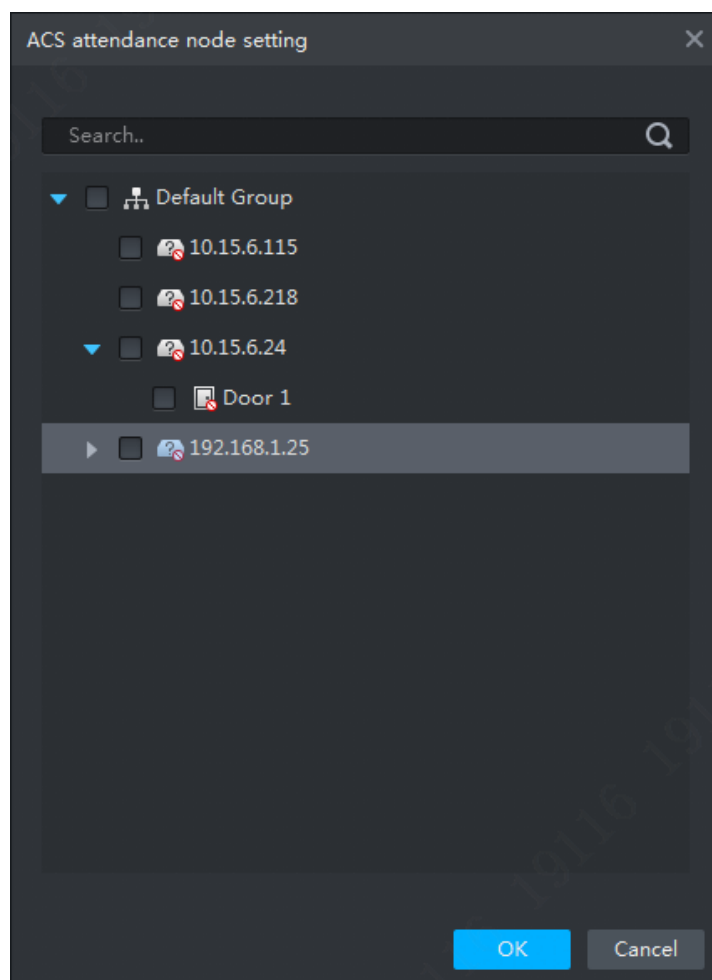

Figure 18-2

Step 3. Select A&C device, click OK. Setup is successful.

Note:

- Via search function, user may quickly find device you want, fuzzy is supported.
- If you want to cancel attendance node, please click cancel a&c, click OK.

18.1.2 Extract Card Info

In organization tree, right click designated time attendance and click Extract Card Info. The system will auto extract card info in the time attendance and show user info, including time, card no., no., name and etc.

18.2 User

User includes department management, user management and right management.

18.2.1 Department/User

Department management and user management functions of time attendance are the same with access module, as well as operations are the same. Info in these two modules can be shared, please see Ch 17.2.

18.2.2 Right

It manages user attendance right.

18.2.2.1 Enable Attendance Right

User may enable attendance right of device.

Step 1. Click . See User interface.

Step 2. Click Access Control, see Figure 18-3.

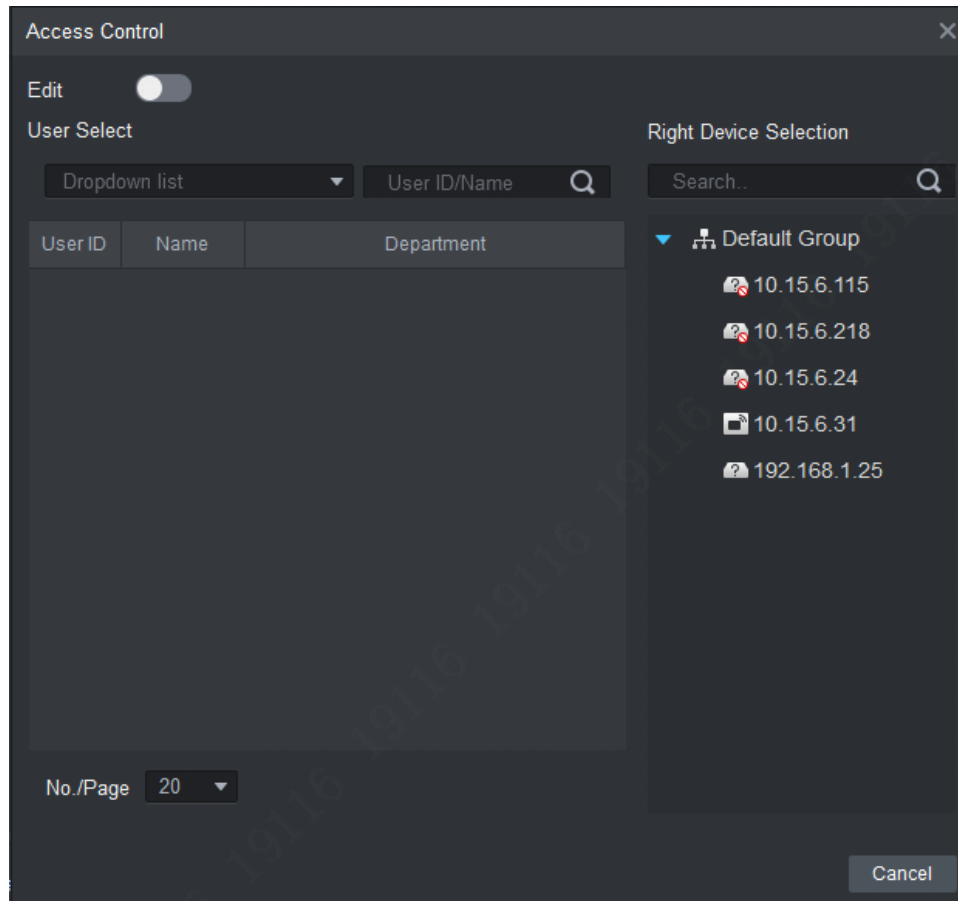

Figure 18-3

Step 3. Click  to enable edit.

Step 4. Select User.

- First select department, and then select user, see Figure 18-4.
- Search user by user ID or name, and select corresponding user, see Figure 18-5.

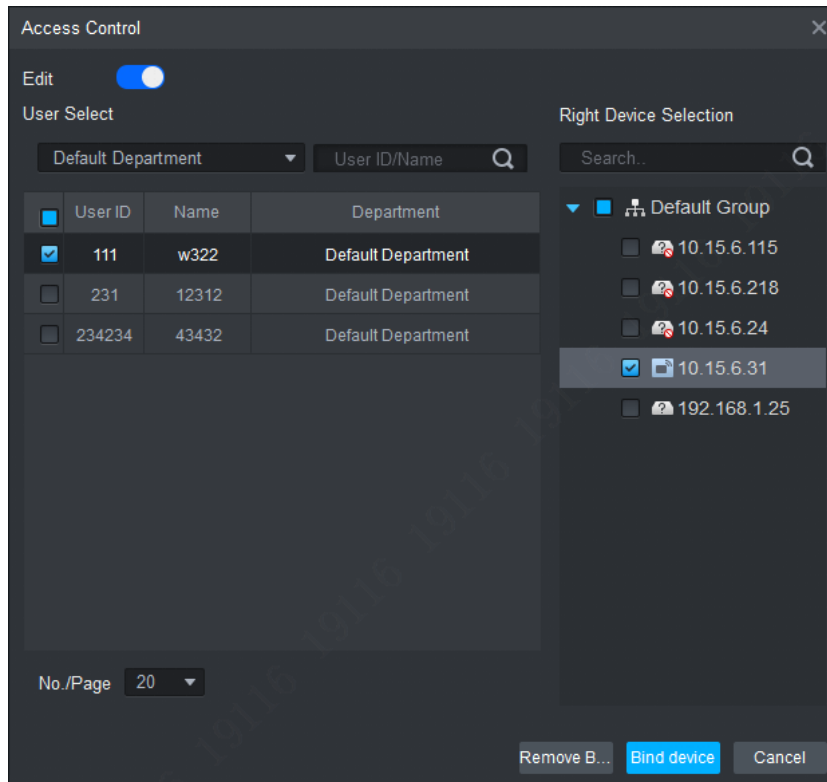

Figure 18-4

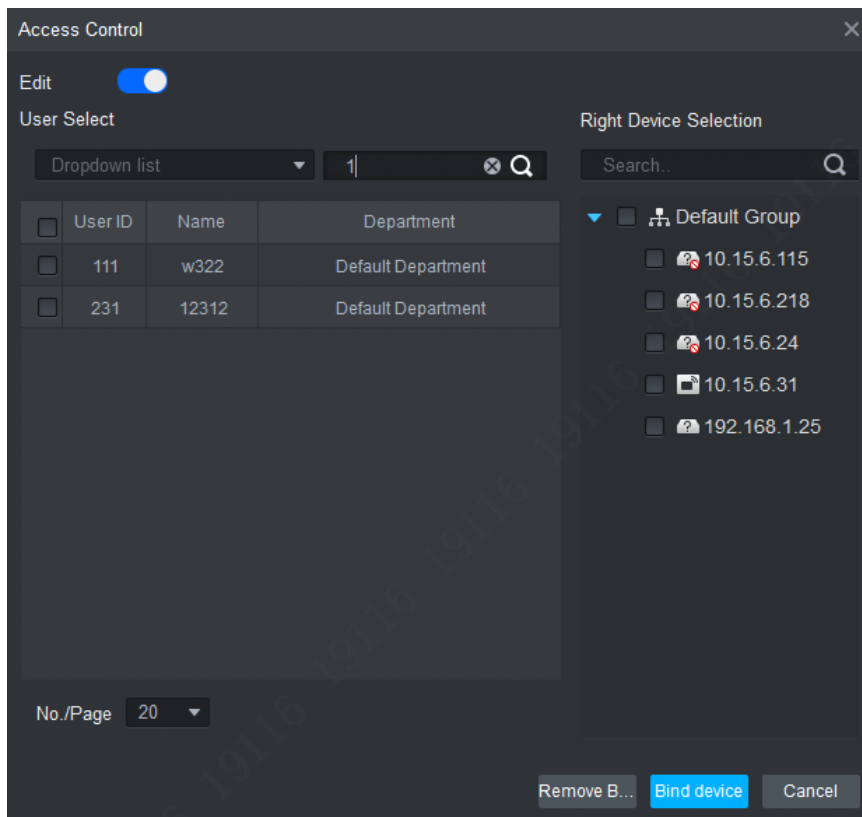



Figure 18-5

Step 5. In device tree, select time attendance. If you want to set more than one device, and to allow employees to sign up on any of these devices, please select more than one devices.
 Step 6. Click Bind Device.

18.2.2.2 Disable Attendance Right

Step 1. Click . System shows User interface.

Step 2. Click Access Control, see Figure 18-3.

Step 3. Select user, to view devices supporting sign up, see Figure 18-6.

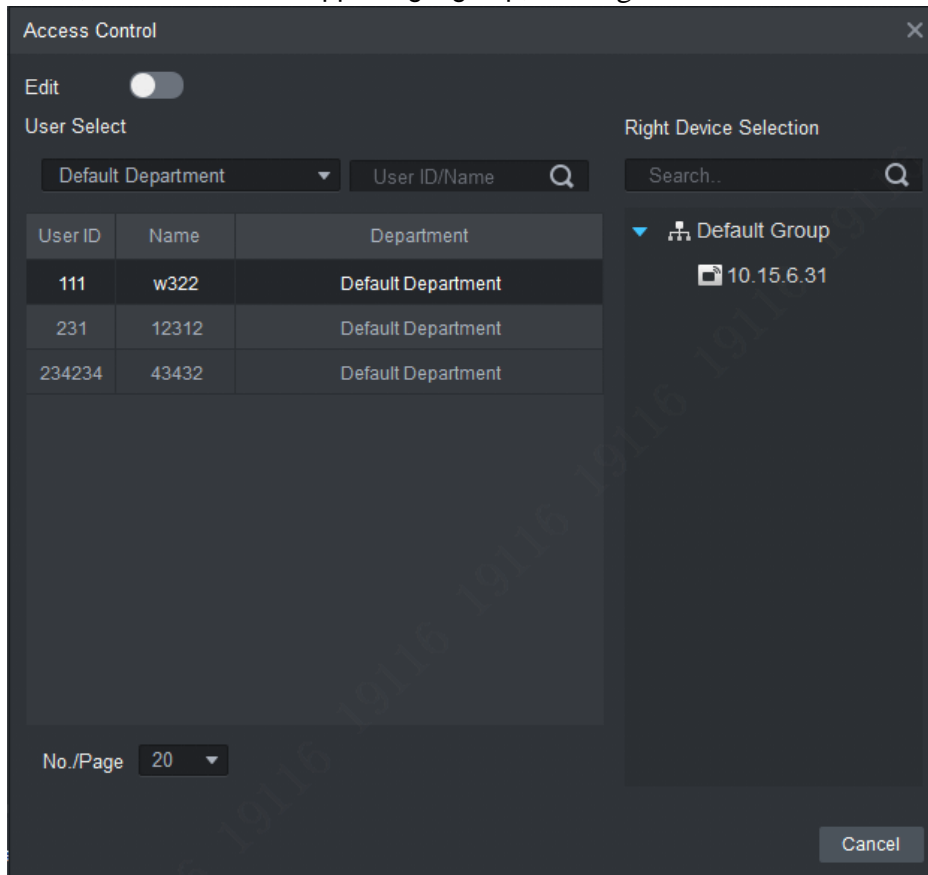

Figure 18-6

Step 4. Click , to enable edit.

Step 5. Select user.

- First select department, and then select user, see Figure 18-4.
- Search user by user ID or name, and select corresponding user, see Figure 18-5.

Step 6. Select time attendance on device tree according to search result.

Step 7. Click Cancel.

18.3 Set Attendance

Set attendance period, shift and holiday.

18.3.1 Set Attendance Timezone

Set timezone of attendance as attendance proof.

Step 1. Click  and select Attendance Timezone. System shows Attendance Timezone interface.

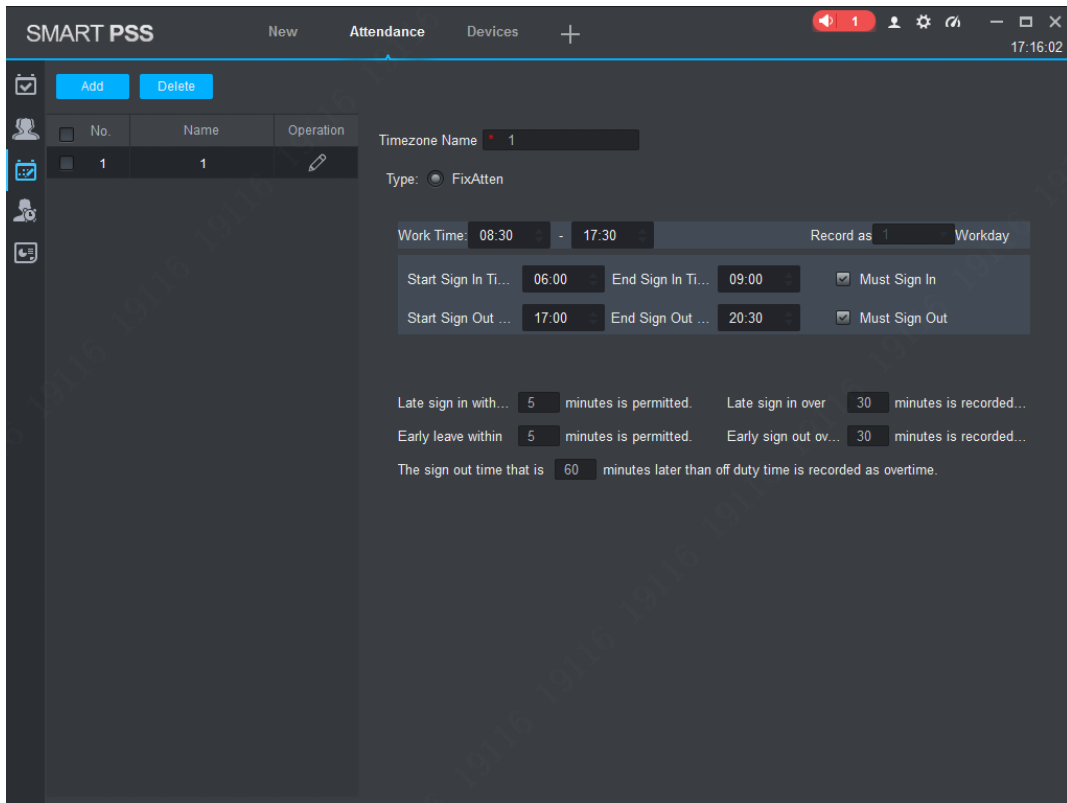

Figure 18-7

Step 2. Click Add.

System pops up New Timezone box, see Figure 18-8.

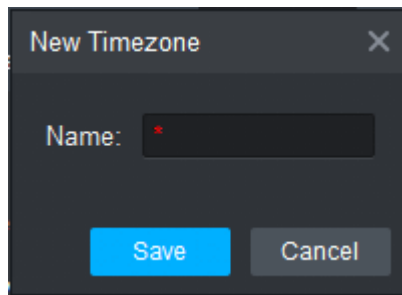



Figure 18-8

Step 3. Enter timezone name (used to identify timezone), click Save.

Step 4. Click  behind timezone to set parameter, see Figure 18-9.

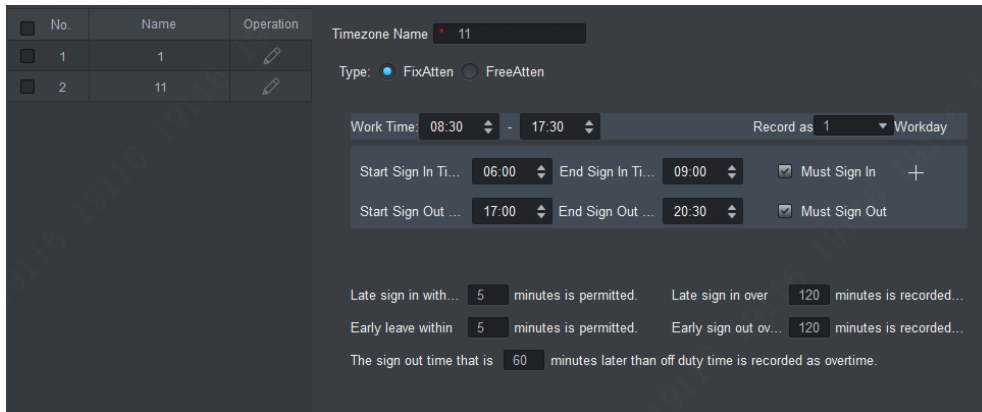

Figure 18-9



| Parameter | Note |
|---|--|
| Time Zone Name | Customize period name. |
| Type | <p>Select work attendance type, including fix and free.</p> <ul style="list-style-type: none"> ● Attendance type is set to fix attendance. For more info, please see the rest of this chart. ● Attendance type is free attendance, and you only need to set duration and whether to limit the latest sign in time. |
| Work Time | <p>Set work time of this period, meantime please select day of week.</p> <ul style="list-style-type: none"> ● If this period of attendance time zone has two separate sub periods, then you shall click  to set second work time sign in/out time. ● If you set two work time, then both time shall have sign in/out to be valid for normal attendance. |
| Record as X Workday | One week time is recorded as how many weekdays. |
| Start Sign In Time | <p>Sign in only within set period on attendance device.</p> <ul style="list-style-type: none"> ● If you set two work time, then both time shall have sign in/out to be valid for normal attendance. |
| End Sign In Time | |
| Start Sign Out Time | |
| End Sign Out Time | <p>Sign out only within set period on attendance device.</p> |
| Late sign in within X minutes is permitted. | <p>Define late, early leave and absence. User may set different time ranges, the followings are example only.</p> <p>Set start time of work time has standard sign in time. Actual time later is than this time, within $5 \text{ min} < X \leq 30 \text{ min}$, will be late.</p> <p>Set start time of work time has standard sign in time. Actual time later is than this time, $X > 30 \text{ min}$, will be absence.</p> <p>Set end time of work time has standard sign out time. Actual sign out is earlier than this time, and $0 \text{ min} < X \leq 5 \text{ min}$, will be early leave.</p> <p>Set end time of work time has standard sign out time. Actual sign out is earlier than this time, and $5 \text{ min} < X \leq 30 \text{ min}$, will be absence.</p> <p>Set end time of work is standard off duty time. Actual sign out time later than this time, and over set value will be overtime.</p> |
| Late sign in over X minutes is recorded as absence. | |
| Early leave within X minutes is permitted. | |
| Early sign out over X minutes is recorded as absence. | |
| The sign out time that is X minutes later than off duty time is recorded as overtime. | |

Chart 18-1

Step 5. Click Save, to save time config.

Note:

- Edit attendance time zone: click  next to attendance time zone to modify.
- Delete attendance time zone: select attendance time zone, click Delete.
- User maynot delete period in progress. If you want to delete it, please go to attendance shift interface and check all shifts to found those linked to the period in progress. If there are linked shifts, please cancel the link first.

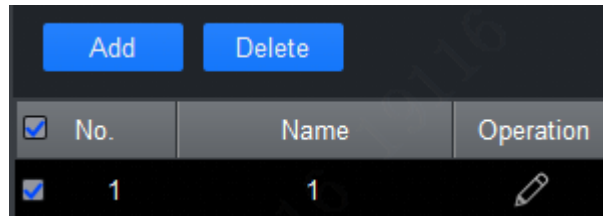



Figure 18-10

18.3.2 Set Attendance Shift

According to attendance time zone, set attendance shift, used for user shift.

Step 1. Click  and select Attendance Shift. See Figure 18-11.

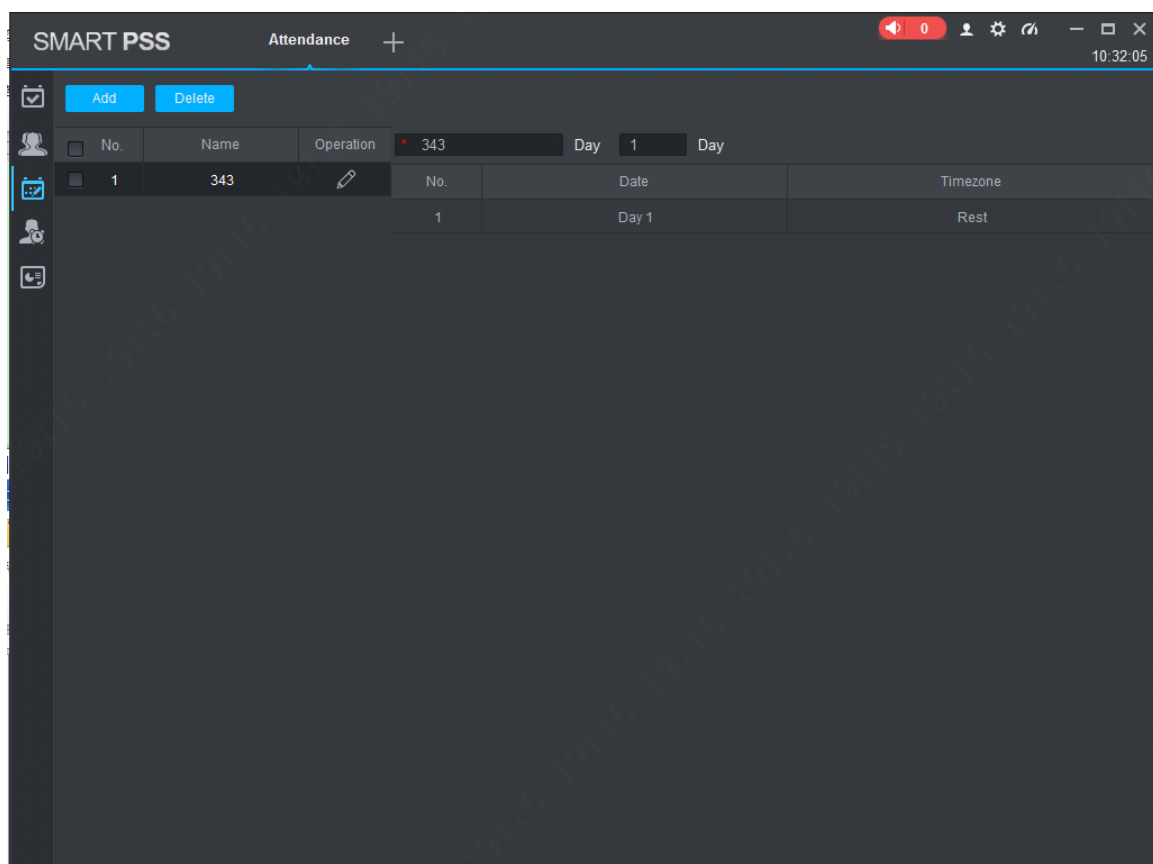

Figure 18-11

Step 2. Click Add. See Figure 18-12.

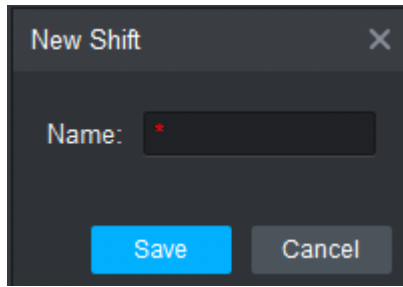



Figure 18-12

Step 3. Enter shift name (name used to differentiate shift), click Save.

Step 4. Click  next to shift to set. See Figure 18-13.

| No. | Name | Operation | 21231 | | | | Week |
|-----|-------|-----------|-------|------|----------|----------------------------|------|
| 1 | 343 | | No. | Date | Timezone | Operation | |
| 2 | 21231 | | 1 | Sun | Rest | Enable all | |
| | | | 2 | Mon | 1 | Enable all | |
| | | | 3 | Tue | 1 | Enable all | |
| | | | 4 | Wed | 1 | Enable all | |
| | | | 5 | Thu | 1 | Enable all | |
| | | | 6 | Fri | 1 | Enable all | |
| | | | 7 | Sat | Rest | Enable all | |

Figure 18-13

| Parameter | Note |
|--------------|--|
| Shift Name | Change shift name. |
| Week Date | Select shift period: <ul style="list-style-type: none"> Week Shift by week, recommended here. After you select week, user may set Monday to Sunday as attendance time zone. Date column will show date as Sunday to Saturday. Month Shift by month, recommended here. After you select month, user may set day 1 to day 31. Day Shift by day, recommended here. After you select day, user may set day of shift. N in Day column means no. N day. |
| Time Zone | Set shift or rest. Ch 18.3.2 introduces shift time zone. |
| Operation | Click Enable All to set time zone of current shift to all other dates. |

Chart 18-2

Step 5. Click Save.

Note:

- Edit attendance shift: click  next to attendance shift to modify attendance shift info.

- Delete attendance shift: select attendance shift, click Delete to delete shift.
- User maynot delete shift in progress. If you want to delete it, please go to attendance shift interface and check all shifts to found those linked to the shift in progress. If there are linked shifts, please cancel the link first.

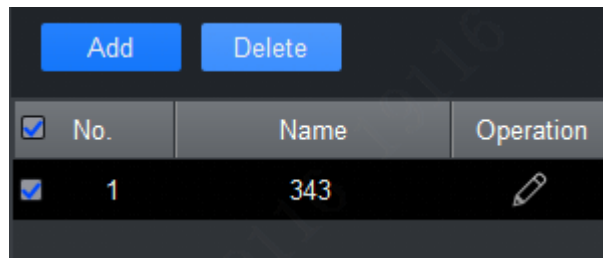



Figure 18-14

18.3.3 Set Holiday

If you have set a date to be holiday, so in general shift shall not set shift on this date, and user may set shift on this date via temporary shift.

Step 1. Click  and select Holiday. See Figure 18-15.

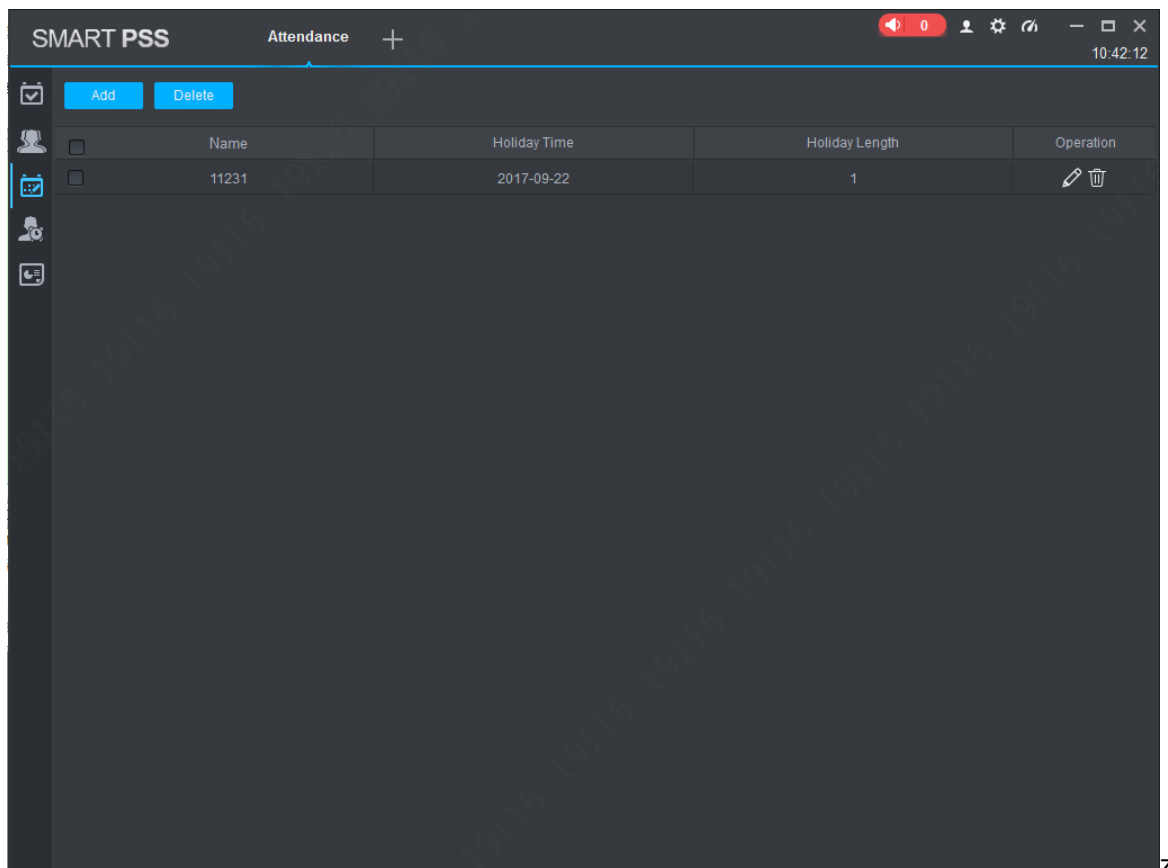

Figure 18-15

Step 2. Click Add. See Figure 18-16.

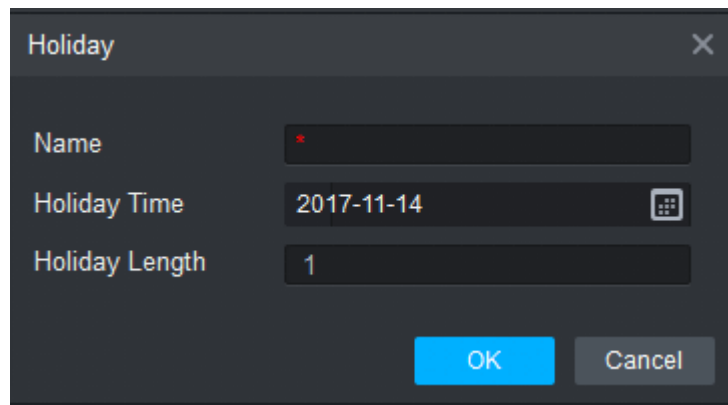

Figure 18-16

Step 3. Set holiday parameter.



| Function | Note |
|----------------|---|
| Name | Enter holiday name. |
| Holiday Time | Set holiday date. If holiday is more than one day, you only need to set the first time. Click  to adjust date, select time, click OK. |
| Holiday Length | Set length of holiday. |

Chart 18-3

Step 4. Click Save.

Note:

- Edit holiday: click  next to holiday to modify holiday info.
- Delete holiday: select holiday, click  Delete to delete holiday.
- Batch delete: select holiday (is selected), click Delete.

18.4 Shift

User shift has general shift and temporary shift.

18.4.1 General Shift

According to attendance user need, set shift.

Note:

Edit existing user shift, steps are same with user shift.

Step 1. Click . See Figure 18-17.

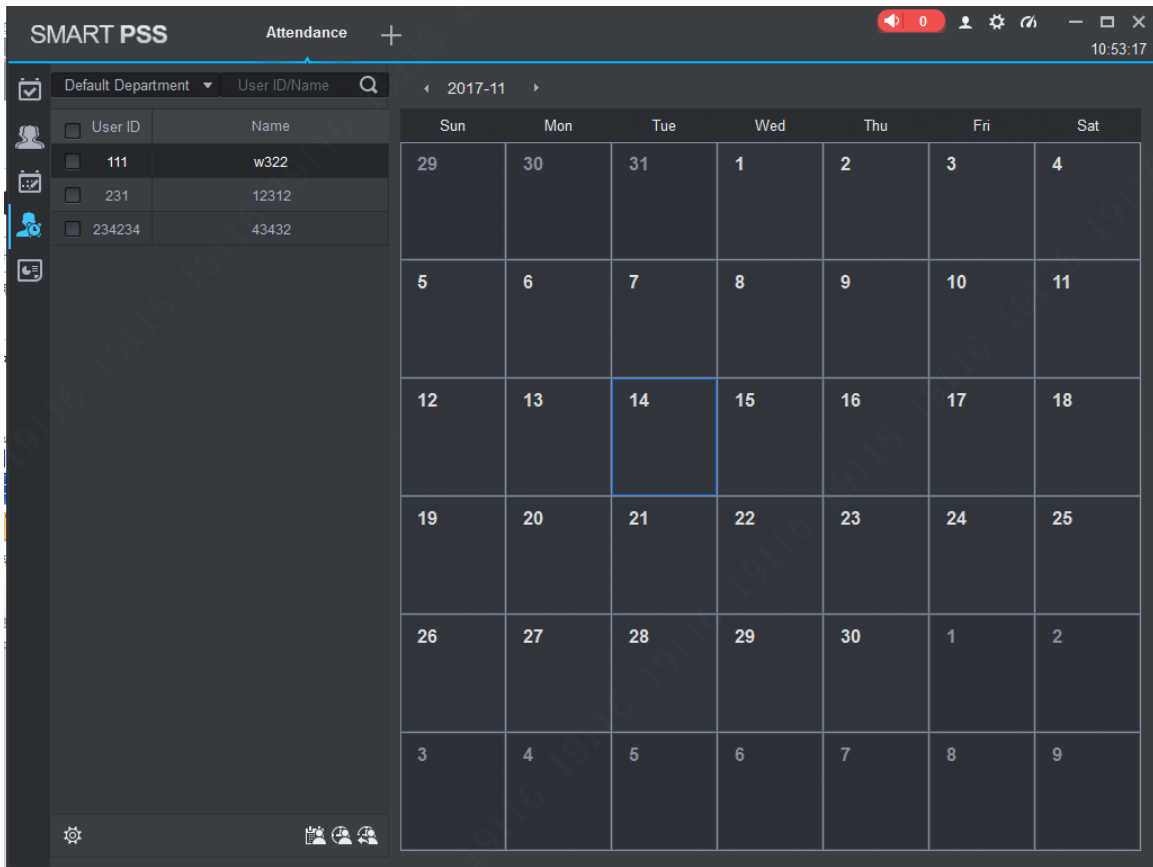

Figure 18-17

Step 2. Select user.

1. Select department. System shows all users in this department.

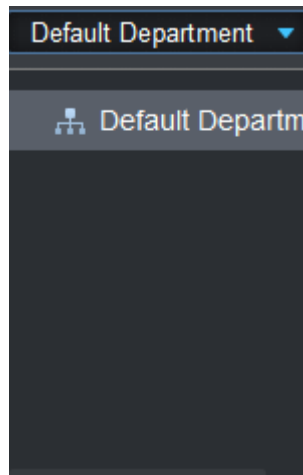

Figure 18-18

2. Select user. See Figure 18-19.

| <input checked="" type="checkbox"/> User ID | Name |
|---|-------|
| <input type="checkbox"/> 111 | w322 |
| <input checked="" type="checkbox"/> 231 | 12312 |
| <input type="checkbox"/> 234234 | 43432 |

Figure 18-19

3. Click .

Shift Select ✕

Selected person number is 1 + 🗑️



| <input type="checkbox"/> SN | Attendance Shifts | Start Time | End Time |
|-----------------------------|-------------------|------------|------------|
| <input type="checkbox"/> 1 | 343 | 2017-09-21 | 2027-09-21 |

OK
Cancel

Figure 18-20

4. Add shift info.

Note:

- User may add more shift info.
- If you want to delete added shift info (is selected), select shift info and click  to delete.
 1. Click  to add one shift info. See Figure 18-21.

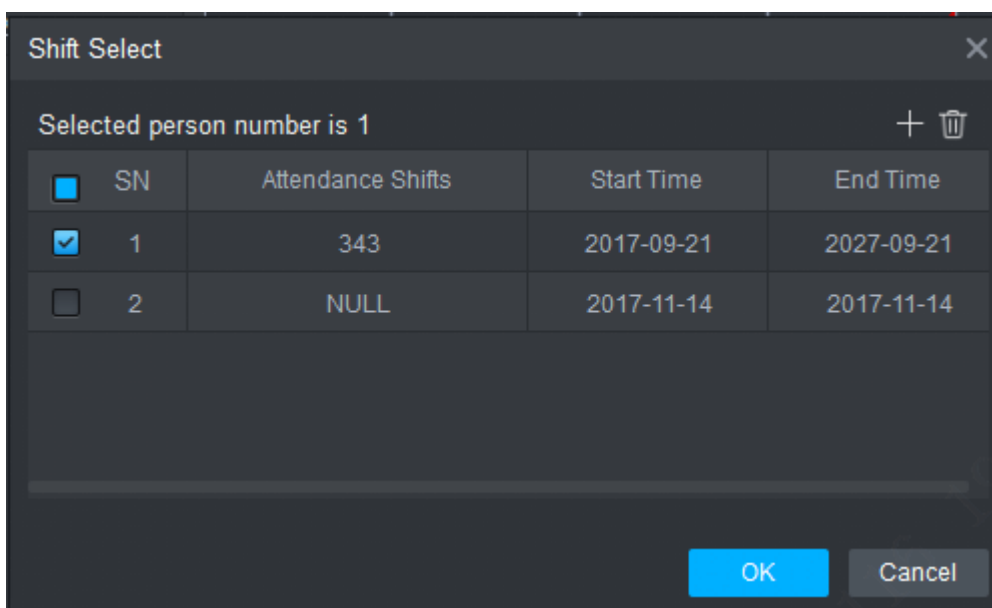

Figure 18-21

2. Set parameter.

| Parameter | Note |
|------------------|---|
| Attendance Shift | Select shift you need. Please refer to attendance shift in Ch 18.3.2. Click corresponding position in shift bar as shift 1 in Figure 18-21 enter edit status and click value you want. |
| Start Time | Set user shift start date and end date. Click bar of start time and select date and time in calendar. |
| End Time | |

Chart 18-4

5. Click OK.

18.4.2 Temporary Shift

Temporary shift as an emergent event occur and you shall add temporary shift to user. User may add and delete temporary shift.

Add Temporary Shift

Step 1. Click .

Step 2. Select user.

1. Select department. See Figure 18-18.
System shows all users in this department.
2. Select user. See Figure 18-19.

Step 3. Add temporary shift.

User may add temporary shift via the following methods:

- Select date (show blue box to mean selected), click .
- Double click date.

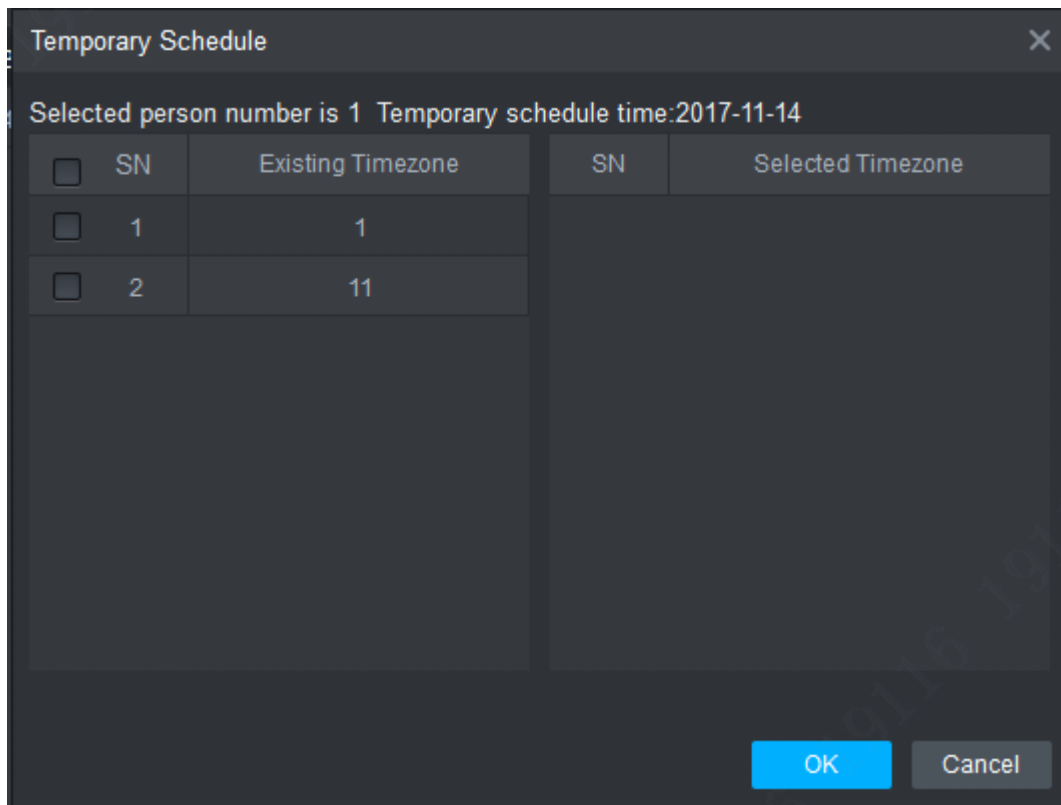

Figure 18-22

Step 4. Select timezone. Click OK

Cancel Temporary Shift

Step 1. Click .

Step 2. Select user.

1. Select department. See Figure 18-18.
System shows all users in this department.
2. Select user. See Figure 18-19.

Step 3. Cancel temporary shift.

User may cancel temporary shift via the following methods:

- Right click date with temporary shift, select Cancel temporary shift to cancel temporary shift.
- Select date with temporary shift (blue box means selected), click . Confirm to cancel.

Note:

Blue "T" in calendar means that this date has temporary shift.

18.4.3 Set Default Shift for New User

After you set default shift for new user, when a user is added, he/she has this shift by default.

Note:

Repeat the following steps to link default shift to more than one department.

Step 1. Click . See Figure 18-17.

Step 2. Select department, see Figure 18-18.

Step 3. Click . See Figure 18-23.

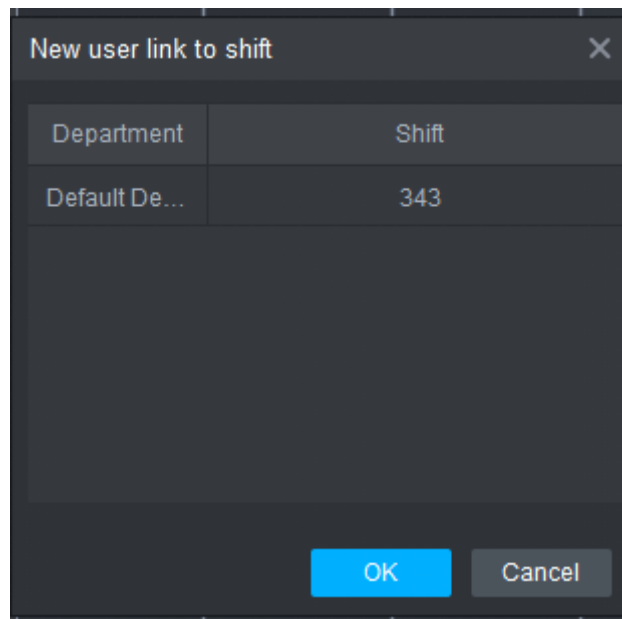

Figure 18-23

Step 4. Click department and select link shift.

Step 5. Click OK.

18.5 Report

In Report interface, user may search and extract statistical info. It supports processing of abnormal attendance.

18.5.1 Extract Attendance Info

If attendance info is only saved at local, then user may extract attendance info into client.

Step 1. Click . See Figure 18-24.

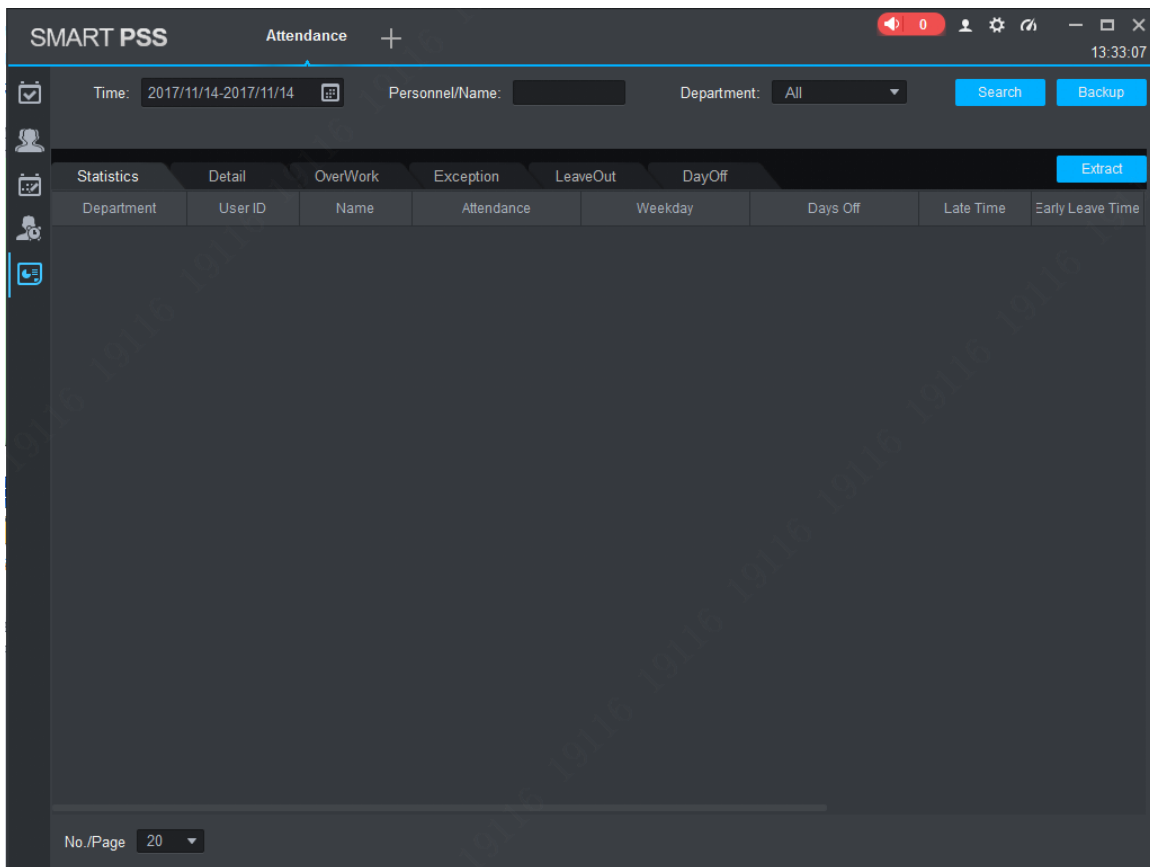

Figure 18-24

Step 2. Click Extract. System shows Manual Extract Record interface, see Figure 18-25.

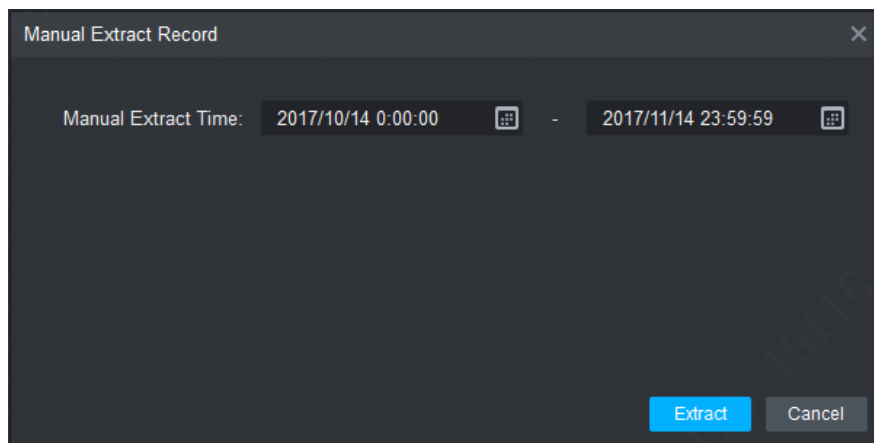

Figure 18-25

Step 3. Set manual extract time and date, click Extract.

Note:

After you extract attendance info, you shall click Search button to refresh attendance info.

18.5.2 Attendance Statistics

It supports statistics of attendance by time, user or department and export to local.

Step 1. Click . See Figure 18-24.

Step 2. Click tab you want to view, see Figure 18-26.

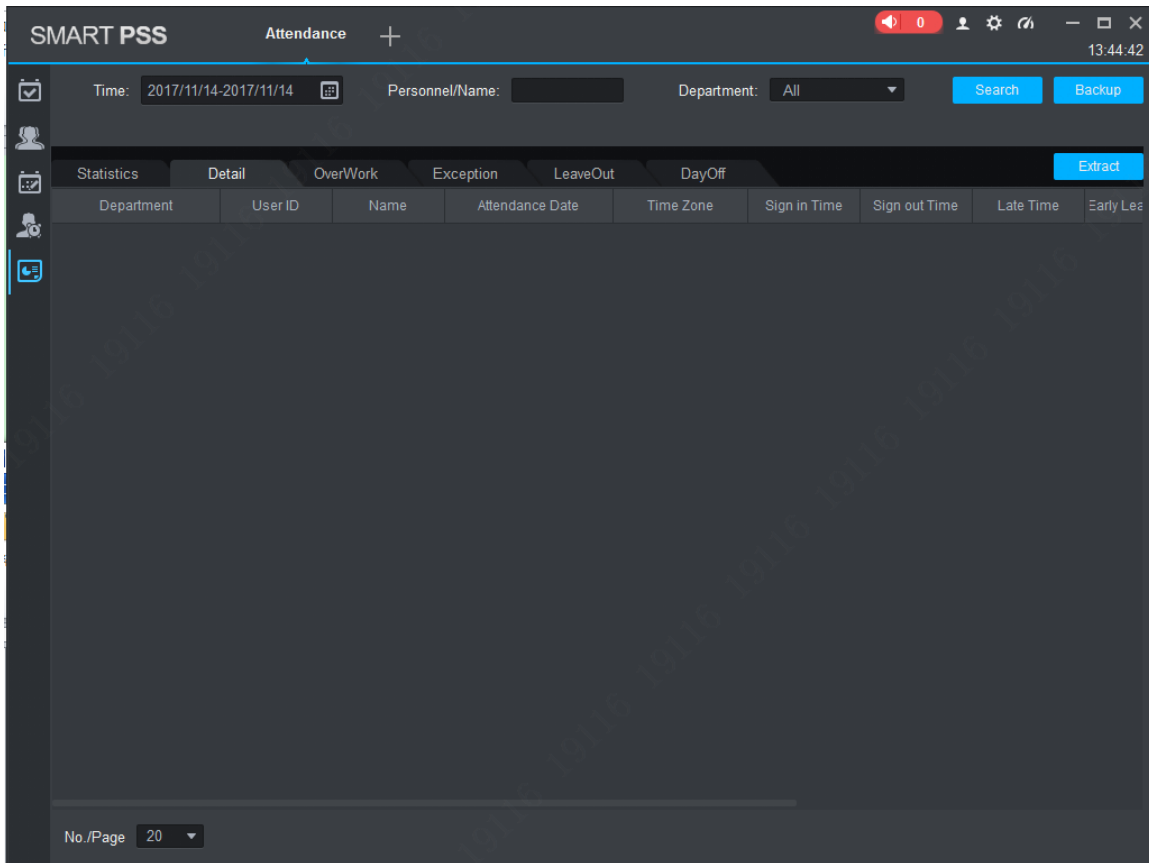

Figure 18-26

Figure 18-27

Step 3. Click Extract to save result as xlsx file at local.

18.5.3 Exception Attendance Processing

Abnormal attendance processing include absence as off duty, or late or early leave fixes.

Step 1. Click . See Figure 18-24.

Step 2. Click Exception tab.

Step 3. Set search criteria and click Search. See Search, see Figure 18-28.

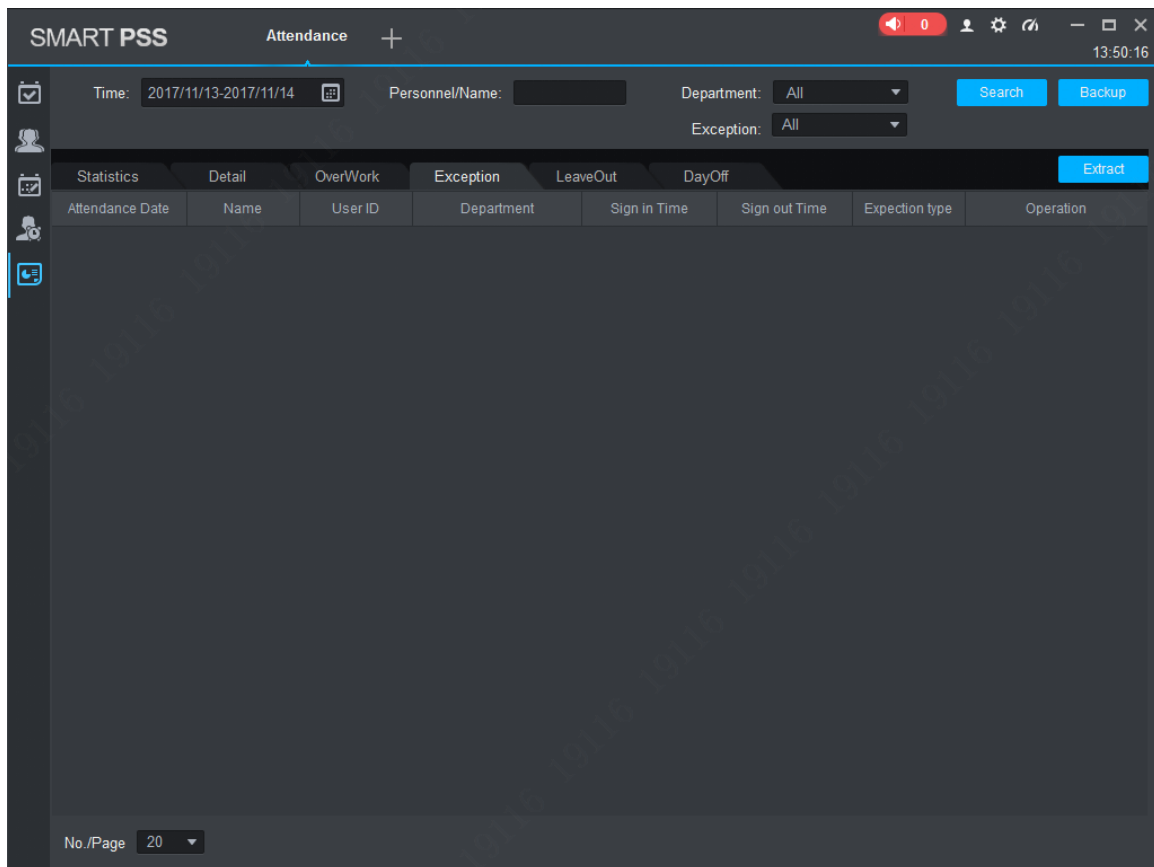



Figure 18-28

Step 4. Click  of item you want to change. In the pop-up window, fix attendance accordingly.
If you want to set exception to off duty, then this fixed item will be no longer shown in exception and meantime an off duty request is created.

Note:

- This manual is for reference only. Slight difference may be found in the user interface.
- All the designs and software here are subject to change without prior written notice.
- All trademarks and registered trademarks are the properties of their respective owners.
- If there is any uncertainty or controversy, please refer to the final explanation of us.
- Please visit our website or contact your local service engineer for more information.

www.dantesecurity.net

sales@dantesecurity.net

support@dantesecurity.net



Alarm Linkage Bullet Camera to PTZ Auto Tracking Function

User manual

V1.0.1

1.1 Preparation

Table 1-1 Data planning

| No | Device name | Device installation address | User name | password | IP address | Subnet mask | Gateway address | DNS |
|----|---------------------------|-----------------------------|--------------------|--------------------|----------------|-------------|-----------------|---------|
| 1 | Bullet | No,1 entrance | admin | Admin123 | 172.12.104.111 | 255.255.0.0 | 172.12.0.1 | 8.8.8.8 |
| 2 | PTZ | No,1 entrance | admin | Admin123 | 172.12.104.112 | 255.255.0.0 | 172.12.0.1 | 8.8.8.8 |
| 3 | PC (For install SmartPSS) | NULL | On-site collection | On-site collection | 172.12.104.113 | 255.255.0.0 | 172.12.0.1 | Null |

1.2 Configuring thermal or standard bullet camera

Modify the IP address of the bullet camera and turn on the smart function. For more bullet camera configuration and operation, please refer to the corresponding WEB instruction manual

1.2.1 Logging in the WEB Interface

Step 1 Input the bullet camera **ip address**, then input **user name** and **password**, then click **login in**

Pic 1-1 login in

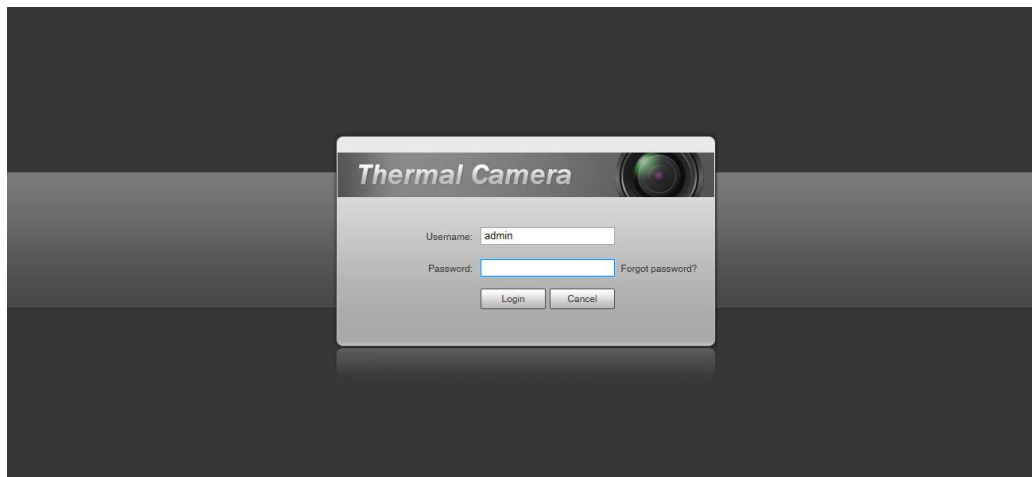

1.2.2 Modify IP address

Modify the IP address of the bullet camera to a pre-assigned IP address to ensure that it does not conflict with other devices in the network. ◦

Step 1 Choose Settings > Network Settings > TCP/IP. ◦

The TCP/IP interface is displayed, as shown in Figure 1-2.

Pic 1-2 TCP/IP

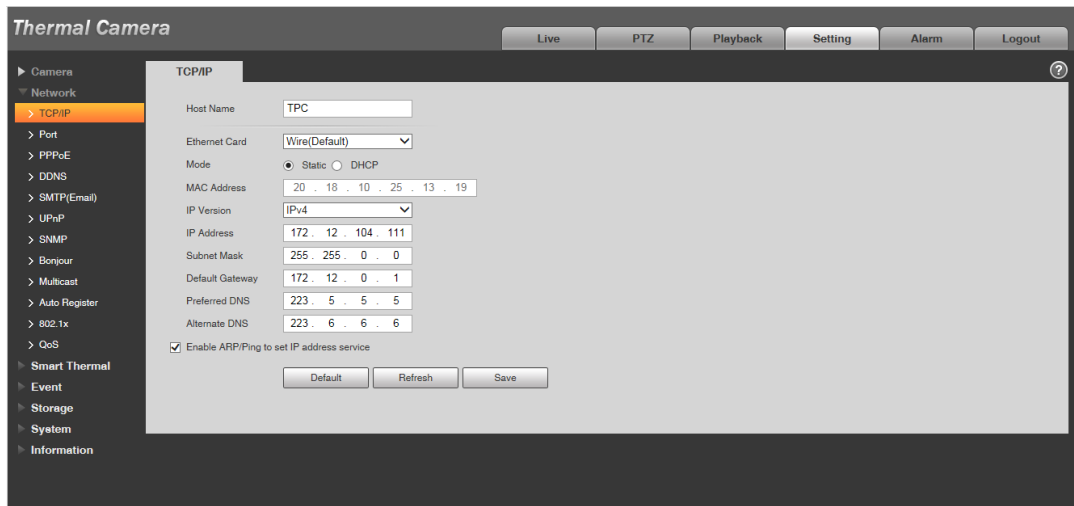

1.2.3 Configuring Intelligence Function

Enable the smart plan and configure the smart rules. If there is an action that matches the smart rules in the preview screen, an alarm is triggered.

1.2.4 Turn on the smart plan

After turning on the smart solution, the device will perform intelligent analysis on the video.

Step 1 Choose Settings > Smart plan > Smart plan.

The Intelligent interface is displayed, as shown in Figure 1-3.

Pic 1-3

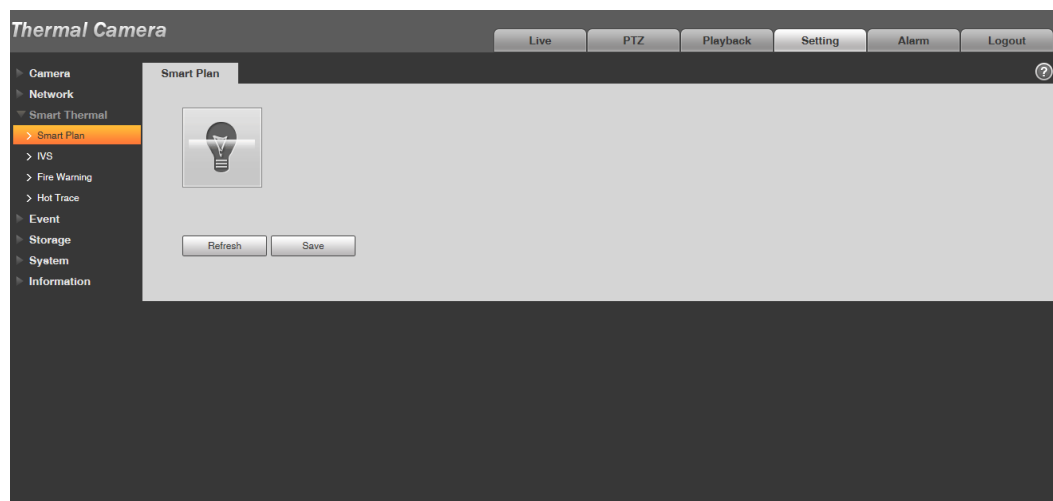



Step 2 click .

Turn on the smart plan, as shown in Figure 1-4

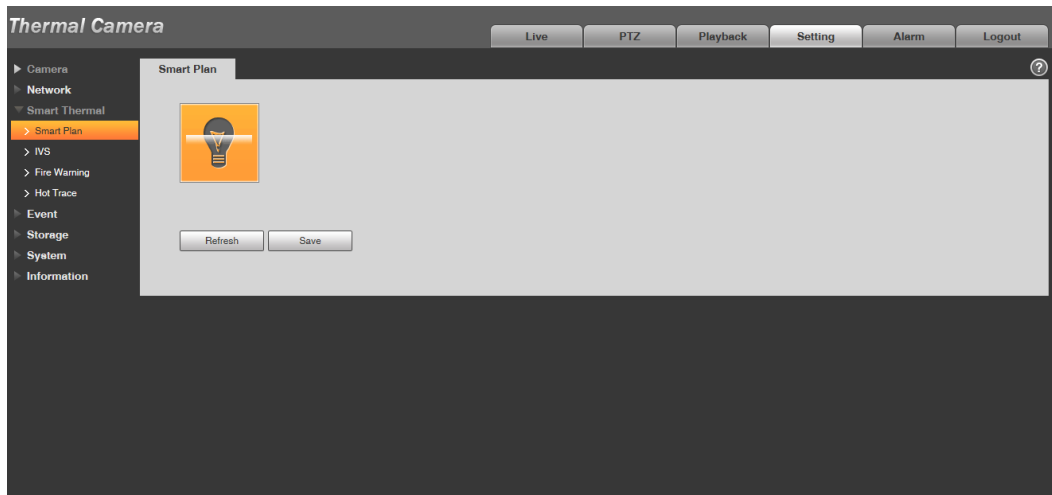
Pic 1-4



: turn on the smart plan.

: turn off the smart plan.

Step 3 Click "save" to save the configuration.

1.2.4.1 Setting the IVS rule

Setting the IVS rule, If an action that matches the smart rule appears in the preview screen, the alarm will be triggered.

Choose Settings > Smart Thermal > IVS> Rule Configuration. The Rule Configuration page is displayed, as shown in Figure 1-5.

Pic 1.5

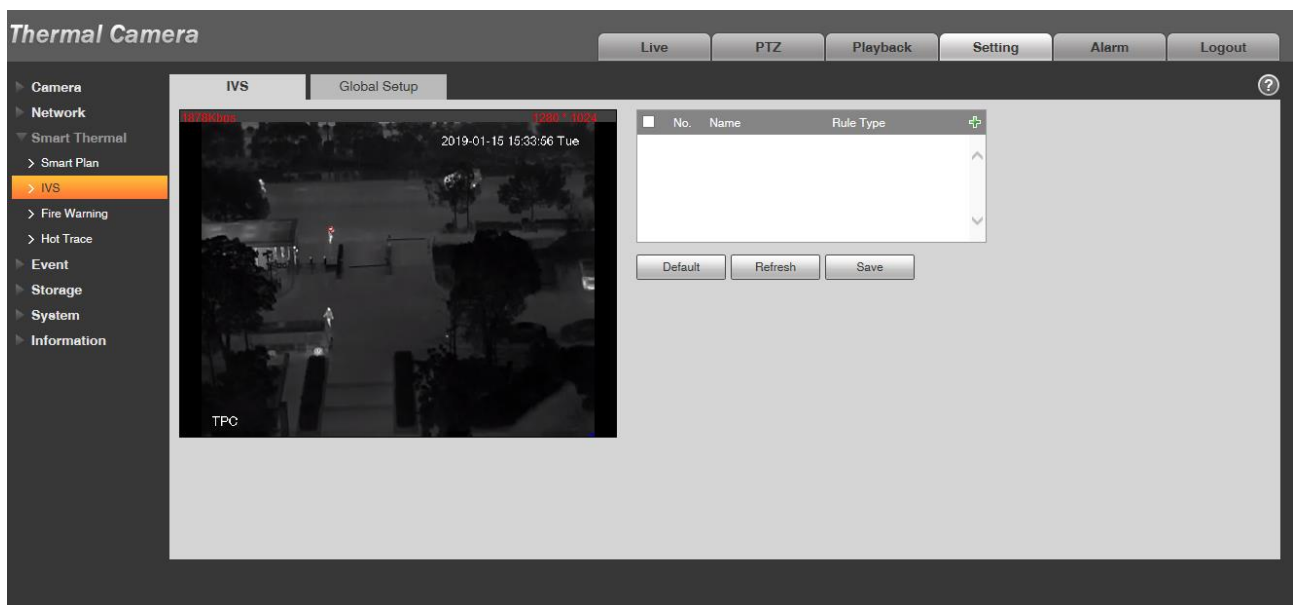

1.2.4.1.1 Tripwire

Triggering an alarm when the target moves across the warning line in the setting direction

Pic 1.6

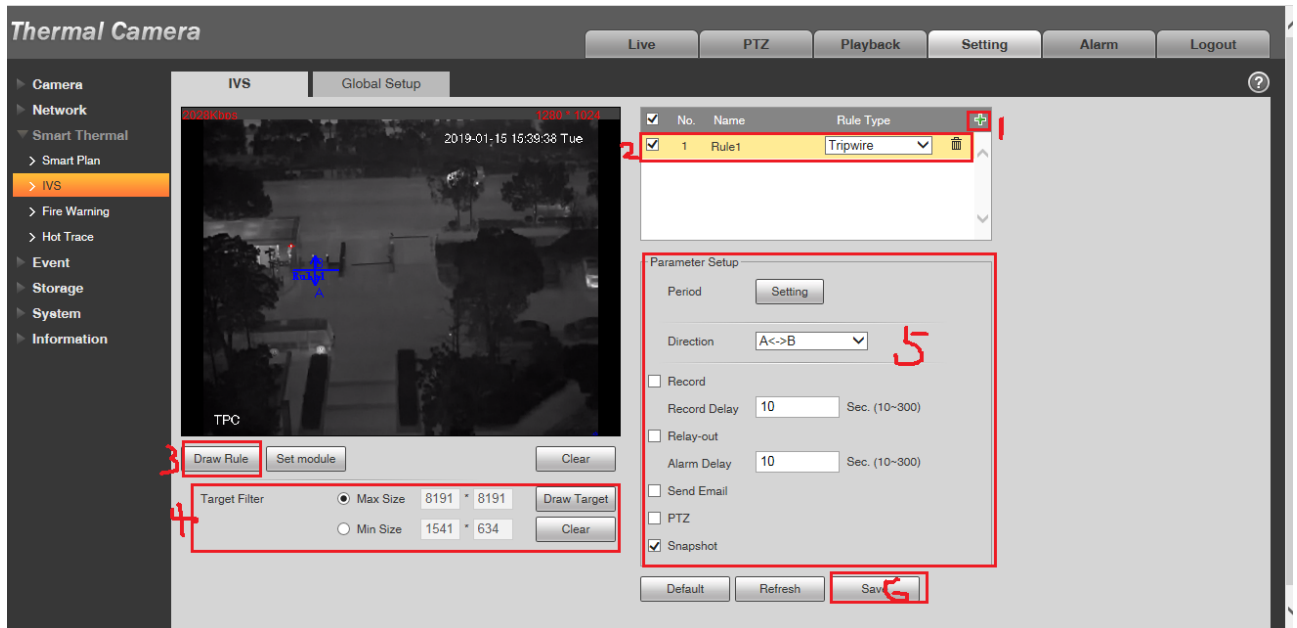

Step 1 click , add rules.

Step 2 Double-click the rule name then add the name what you want; Double-click the rule type, choose the “Tripwire”

Indicates that smart rules are enabled.。

Indicates that smart rules are not enabled.。

Step 3 Click Draw Rule to draw the rule on the video and right click to ending the draw.。

Step 4 Choose max size, Click "Draw Target", drag or drop any corner of the filter box to enlarge or reduce the filter frame to the appropriate size; similarly, draw the minimum size.

Step 5 Click the “save ” to save the config.

1.3 Configuring the PTZ

Modify the PTZ IP address and complete the preset configuration. For more configuration and operation of the PTZ , please refer to the corresponding WEB instruction manual.

1.3.1 Modify the PTZ IP

The same with bullet camera

1.3.2 Configuring Preset

The preset point is preset the camera monitoring position, and the pan/tilt and camera are quickly adjusted to the setting position by calling the preset point.

Step 1 Choose Setting > PTZ > function > Preset”, to add the present

Pic 1-7

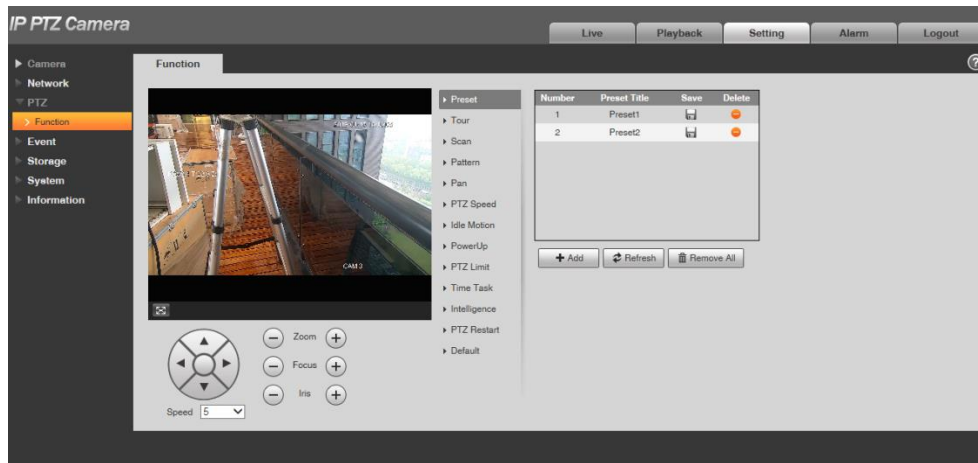

Step 2 Setting the present.

1. Click Add to add a preset point.
2. Control the direction, zoom, zoom and aperture of the pan/tilt and adjust the camera to the appropriate monitoring point.
3. Double-click the title of the new preset point, modify the name, and click save the configuration

1.4 Configuring the SmartPSS Client Software

Tru the calibrating the bullet camera on the smartpss to realize the bullet-PTZ smart tracking.Based on this action to realize the Manual positioning, 3D positioning, manual tracking and smart tracking

Click the smartpss icon to login in

Pic 1-8

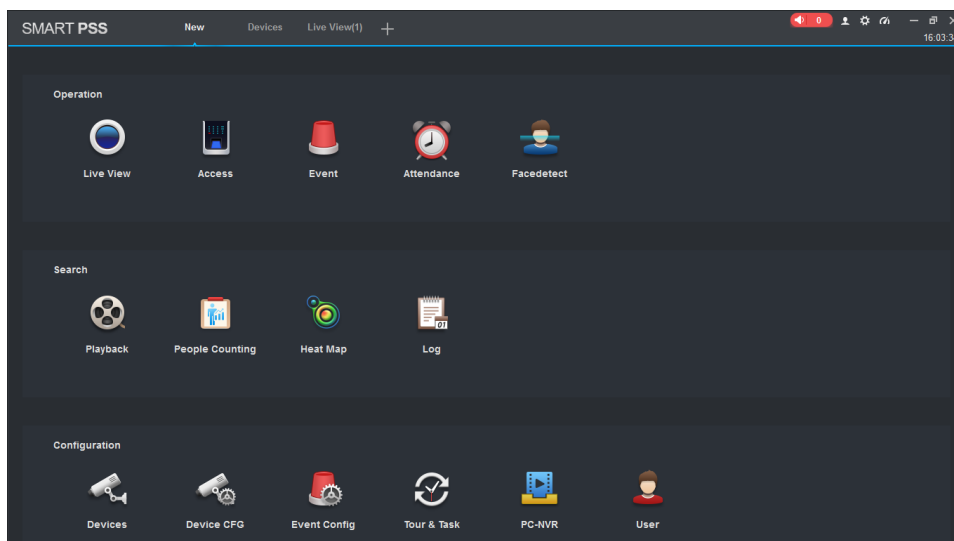

1.4.1 Add the device (thermal or standard Bullet camera and PTZ)

Pic 1-9

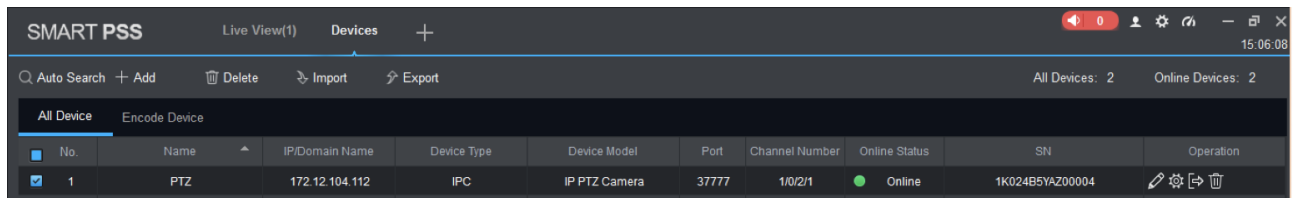

1.4.2 Calibrating the Bullet and PTZ



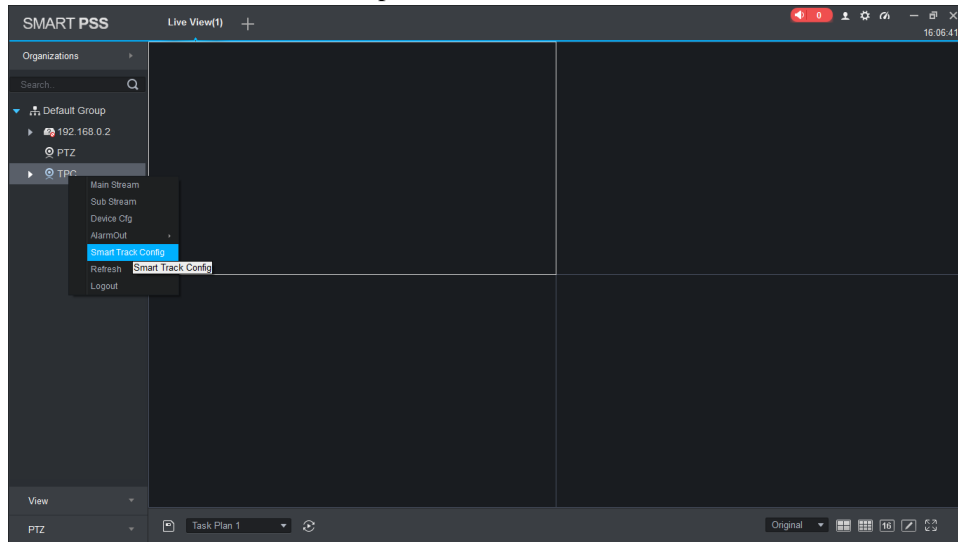

Step 1 choose “preview” . Just as the following pic shown

Step 2 in the group ,on the TPC ,then right click the “smart tracking config”,just as the pic 1-10
pic 1-10

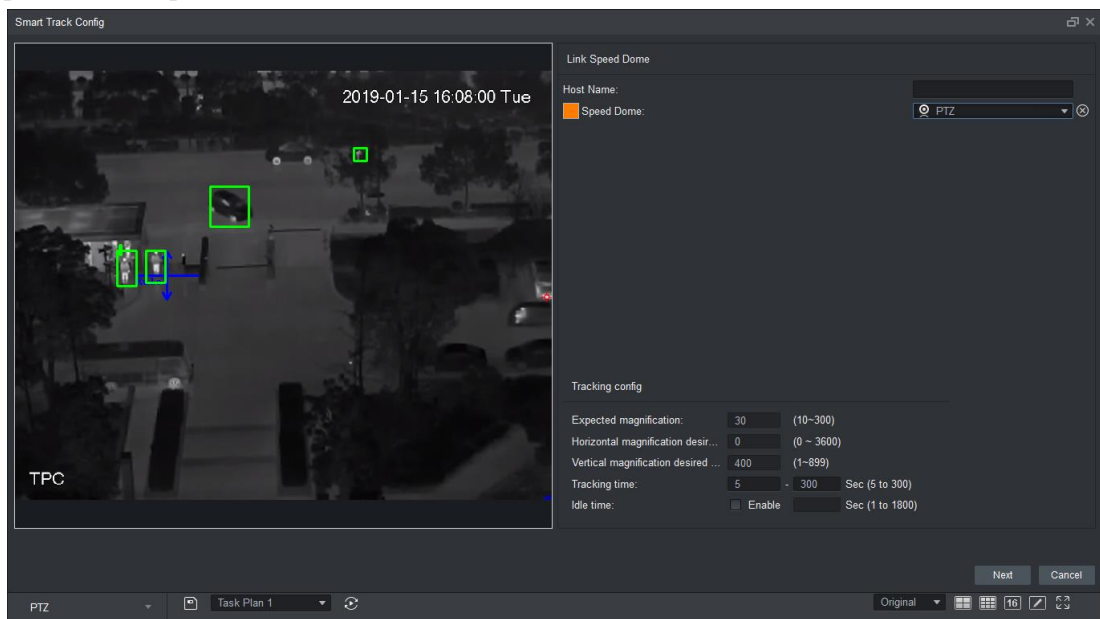

Step 3 link the speed dome



1. Click , then select the ptz.
 2. Click “next”.
- The smartpss show the smart tracking interface

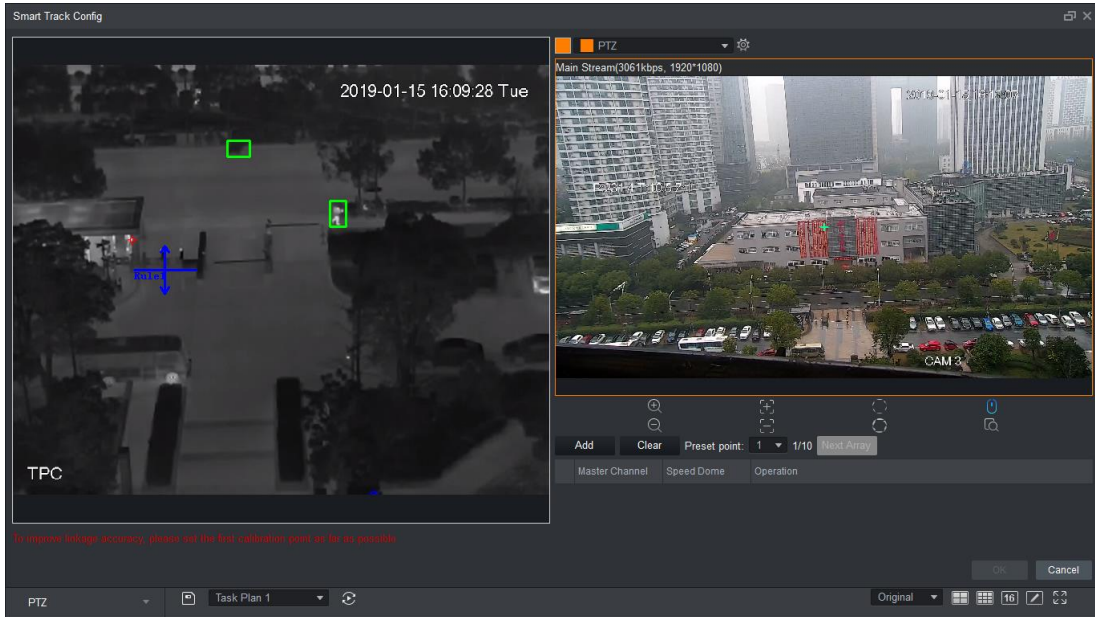

Step 4 Calibrating the bullet camera and ptz

Noted:

The tag is configured with a minimum of 4 pairs for each group, and at least 2 groups are recommended. It is recommended to configure 4 pairs, 2 groups.

Fig 1-11 Calibrating the bullet camera and ptz

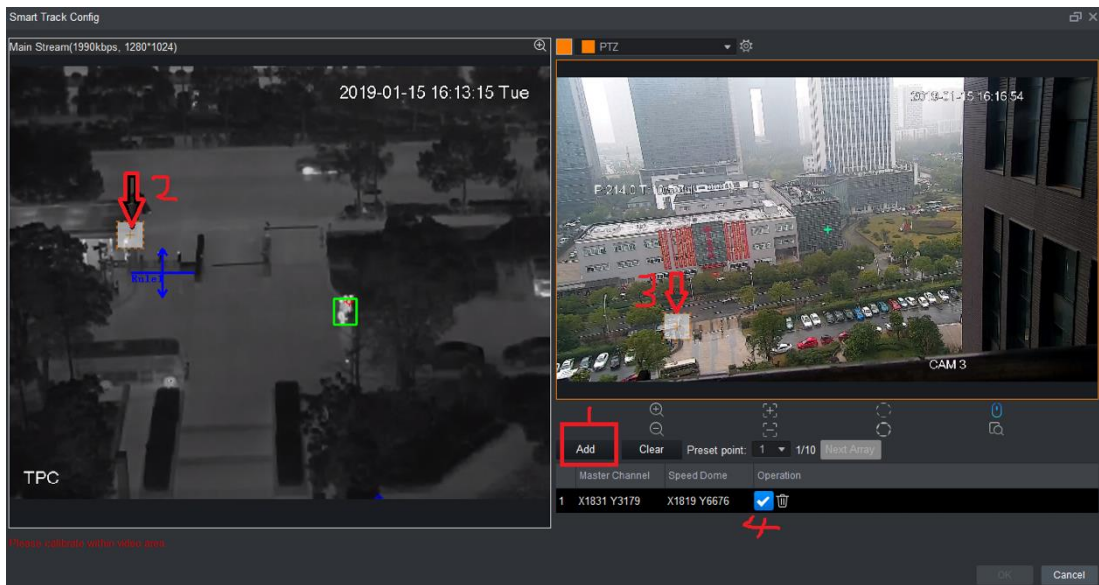



1. Click “add”.
A cross mark appears on the screen of the bullet camera, a center cross mark appears in the screen of the PTZ camera, and a record is generated at the same time.
2. Dragging the cross mark in the bullet camera to the appropriate position.
3. Make sure the ball machine has the Z value is 1, and dragging the cross mark in the PTZ

to **the same position** as the bullet camera.。

Noted:

The bullet camera **T value must be positive**, the negative value cannot be calibrated.。

4. Click , save information
5. Repeating steps 1 to 4 to complete the configuration of 4 pairs of marker pairs.。
6. After completing the first array of tag pairs, click on “Next Array”, Repeat step 1-5, then choose , Rotating the PTZ, Click “save” save the info.。

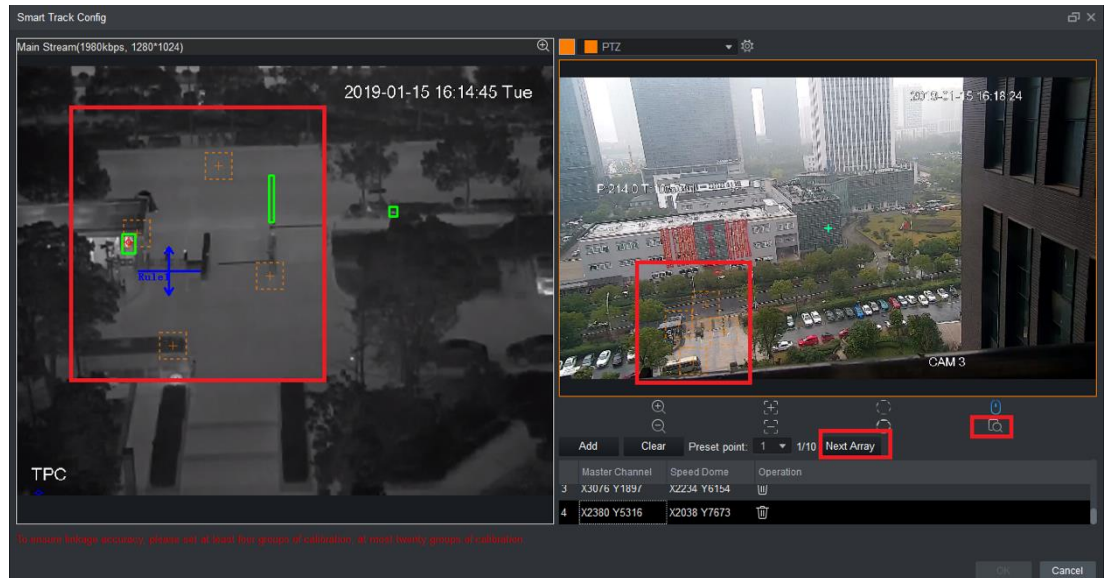

1.5 Bullet camera + PTZ Compensation setting

Choose Setting > Smart Thermal > IVS > Global Configuration to compensate for the P and T values of the PTZ.。

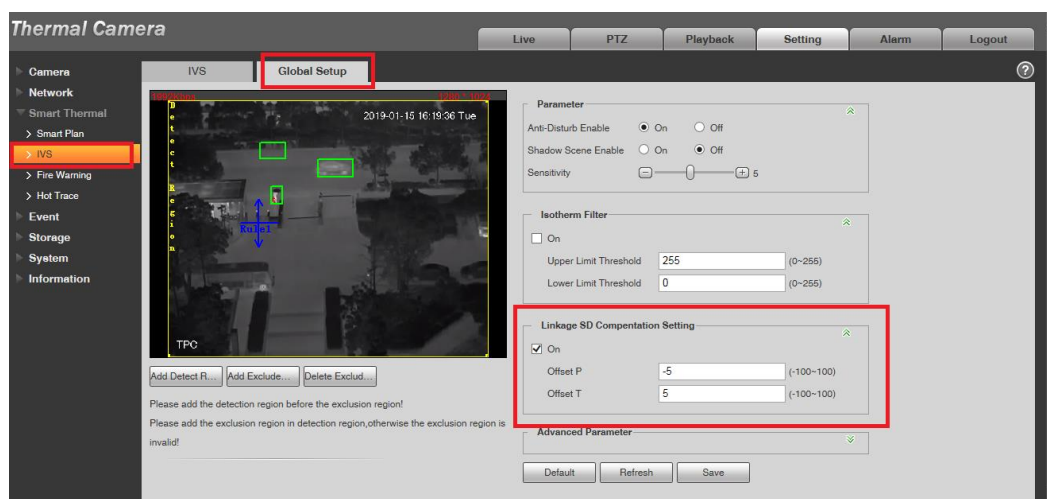

Noted:

Must be successfully calibrated before using this function.。



Alarm Linkage Thermal bullet to PTZ Pattern Function

V1.0.0

1.1 Preparation

Table 1-1 Data planning

| No | Device name | User name | password | IP address | Subnet mask | Gateway address | DNS |
|----|---------------|-----------|----------|---------------|---------------|-----------------|---------|
| 1 | Bullet camera | admin | admin123 | 192.168.1.119 | 255.255.255.0 | 192.168.1.1 | 8.8.8.8 |
| 2 | PTZ | admin | admin123 | 192.168.1.118 | 255.255.255.0 | 192.168.1.1 | 8.8.8.8 |
| 3 | NVR | admin | admin123 | 192.168.1.120 | 255.255.255.0 | 192.168.1.1 | 8.8.8.8 |

1.2 Configuring PTZ pattern function

1.2.1 Logging in the WEB Interface

Step 1 Input the PTZ **ip address**, then input **user name** and **password**, then click **login in**

Pic 1-1 login in



1.2.2 Configuring pattern Function

Step 1 Choose Setting > PTZ > function>pattern

The Intelligent interface is displayed, as shown in Figure 1-2

Pic 1-2

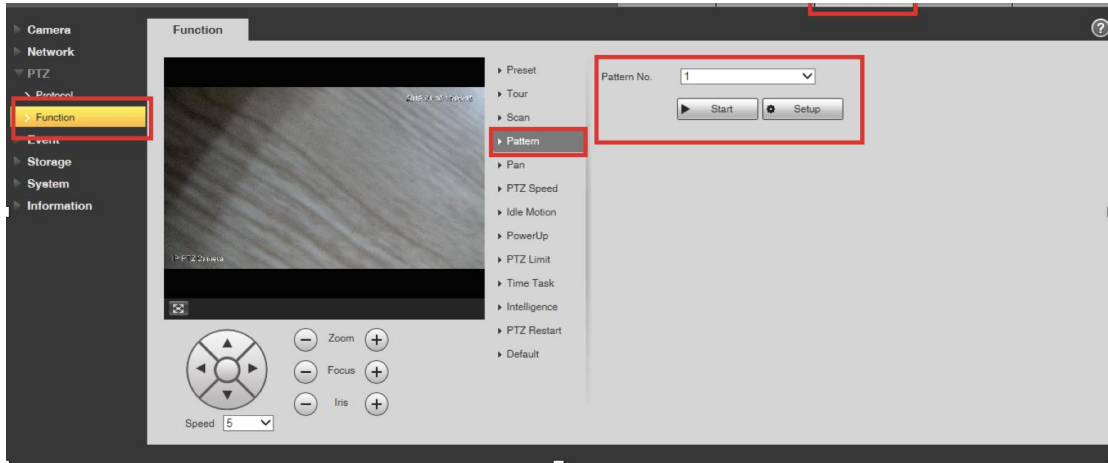

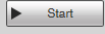
Step 2 click , then start the No 1 pattern function.

Step 3 click , then stop the No 1 pattern function.

1.2.2.1 NVR setting

1.2.2.1.1 Add the device

On the NVR local interface, add the PTZ and Thermal bullet camera to the NVR

Choose Camera > Registration > manual add, then add the PTZ and thermal bullet camera successfully.

Pic 1.5

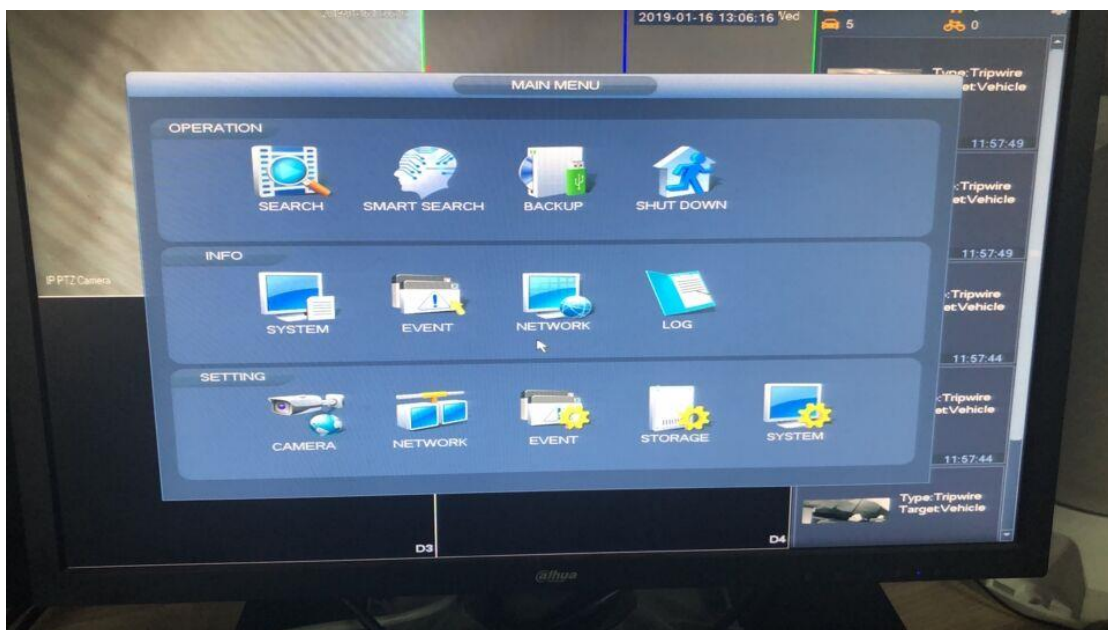

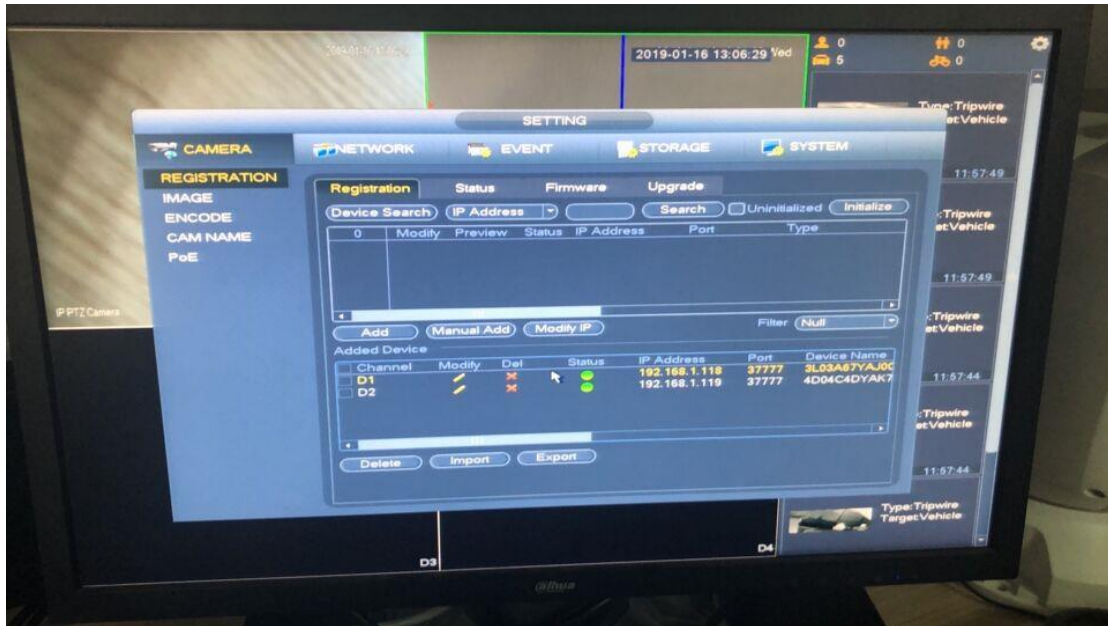

1.2.2.1.2 Tripwire

Triggering an alarm when the target moves across the warning line in the setting direction

Pic 1.6

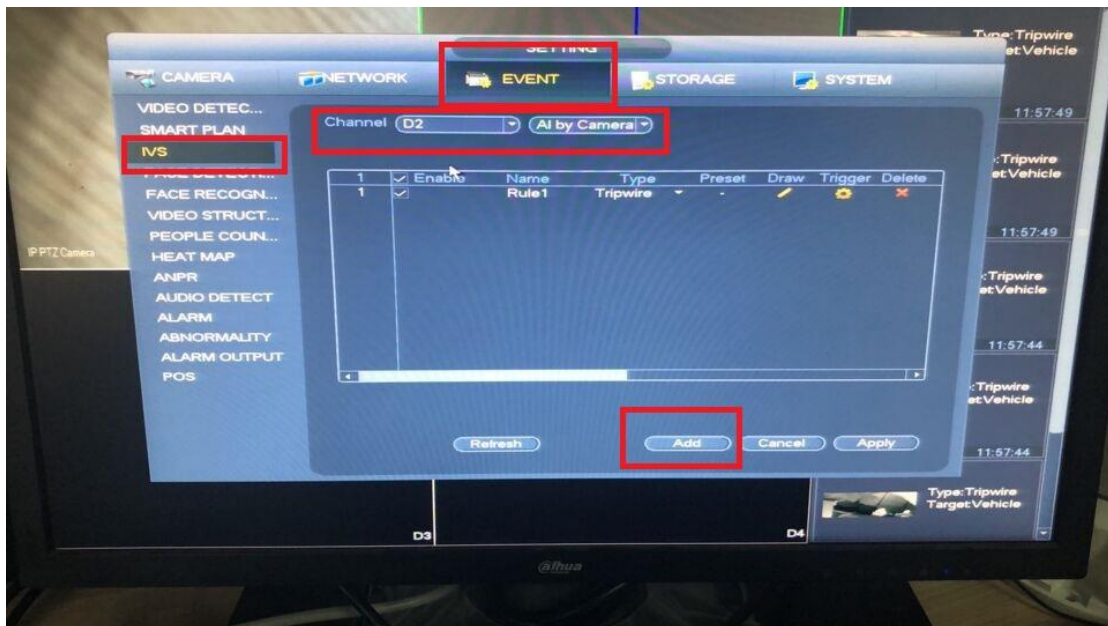

Step 1 click the EVENT> IVS >Add, then add the thermal bullet camera “Tripwire” rules.

Step 2 click the **trigger** button then select the **PTZ activation**, click “**setting**”, choose “**pattern**” for the PTZ.

Step 3 click “save”, save the configuration.

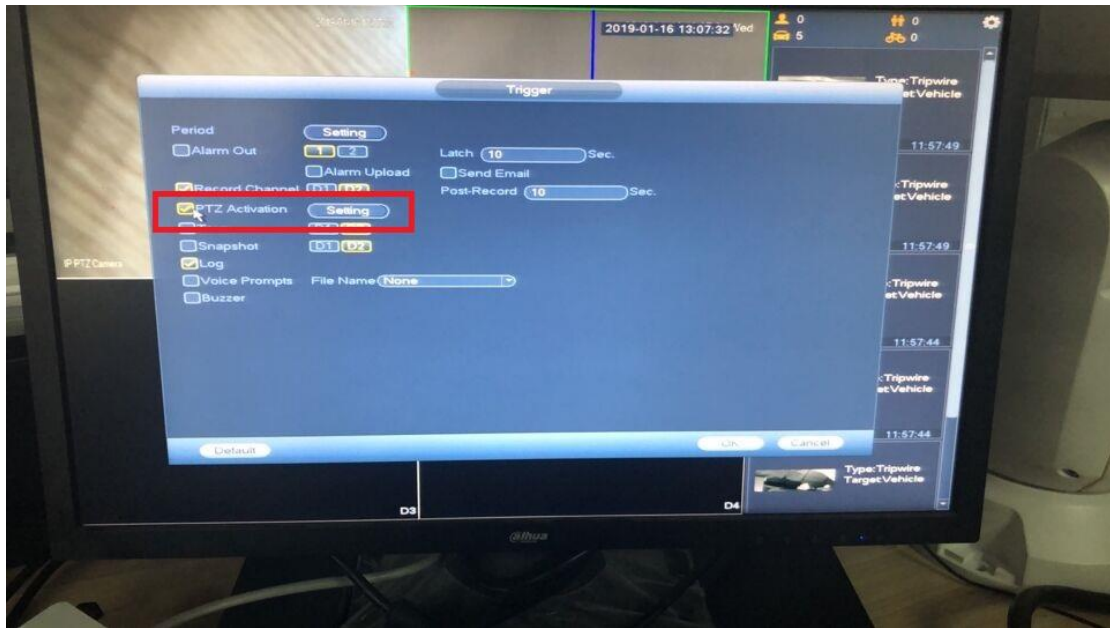
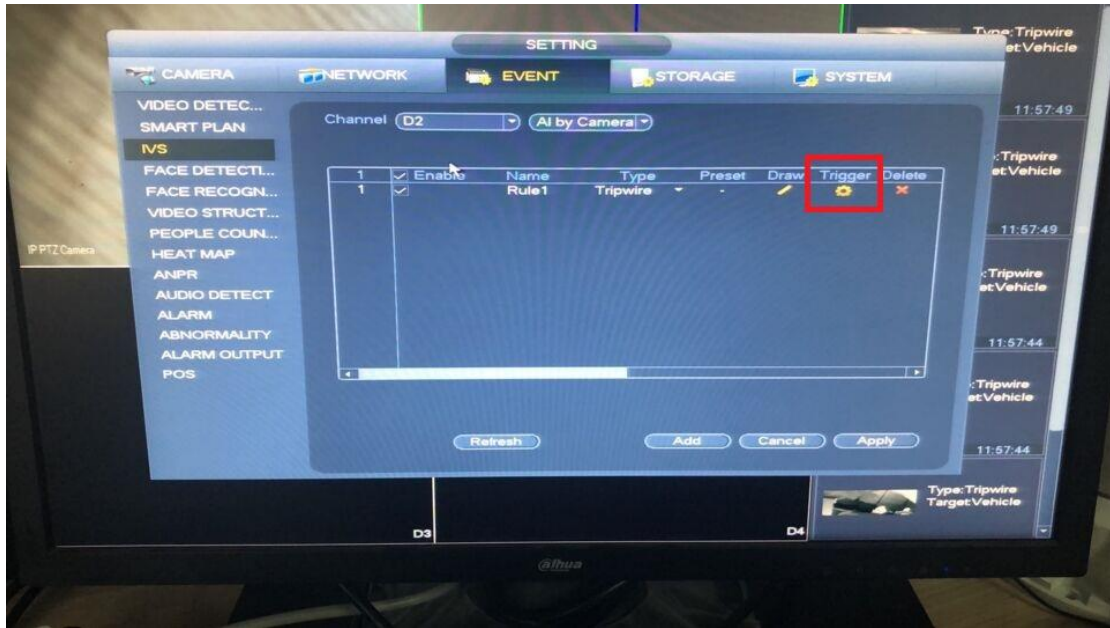

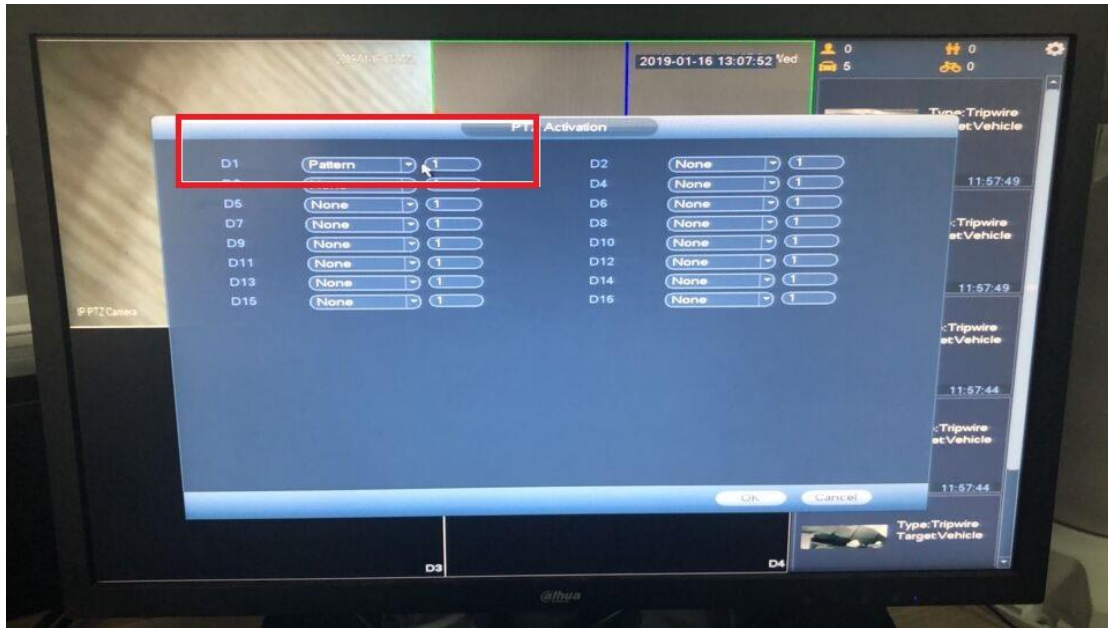

1.3 Trigger the rules. Realize the function

Back to the preview interface, when the thermal bullet camera trigger the rules, it can link the PTZ to realize the pattern function.

www.dantesecurity.net
sales@dantesecurity.net
support@dantesecurity.net